



KANOMAX
The Ultimate Measurements

CAPTURE HOOD

MODEL 6710 version 2

INSTRUCTION MANUAL



Be sure to read this manual thoroughly before using the instrument.

Fully understand and pay attention to each caution mentioned.

Please keep this manual as a service reference.



01003

15 . 08

Thank you for your purchasing a KANOMAX instrument. This is a precision instrument, please read this instruction manual carefully before using the instrument and pay attention to all the cautions under the instructions.

Composition & Parts

■ Standard part:

Model No.	Functions
6710	Air quantity/temperature/humidity

■ Standard components:

Items	Qty
Main structure	1
User Manual	1
Carrying Case	1
Instrument Base	1
2ftx2ft Fabric hood	1
Frame poles for 2ftx2ft hood	4
Communication cable	1
Software Installer	1

■ Optional components:

Items	Specifications
Frame poles for other hood sizes	
Printer	
Cable	
Up-down Stand	
AC adapter	
Fabric hood	2ftx4ft
	1ftx4ft
	3ftx2ft
	3ftx3ft

ATTENTIONS & NOTES

The warning symbols mentioned in this manual are defined below:

[symbol classifications]



Danger: To Prevent Serious Injury or Death

Warnings in this classification indicate a danger that may result in serious injury or death if not observed.



Caution: To Prevent Damage to the Product

Warnings in this classification indicate a risk of damage to the product that may void the product warranty if not observed.

Description of Symbols









△ This symbol indicates a condition that requires caution (including danger). The subject of each caution is illustrated inside the triangle (e.g. the high temperature caution symbol is shown on the left).



⊘ This symbol indicates a prohibition. Do not take the prohibited action shown inside or near this symbol (e.g. the disassembly prohibition symbol is shown on the left).

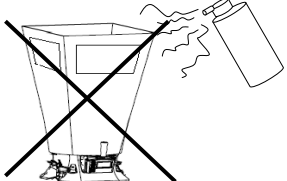

● This symbol indicates a mandatory action. A specific action is given near the symbol.

 WARNING		
 Heating forbidden	<ul style="list-style-type: none"> ● Never bring the fabric hood into a flammable gas atmosphere. Otherwise, the heat may cause a fire or a explosion. 	
 Disassembly prohibition	<ul style="list-style-type: none"> ● Do not disassemble or refit the instrument. Otherwise, it may cause an electric shock or a fire. 	
 Using properly	<ul style="list-style-type: none"> ● Use the instrument properly by following the directions in this instruction manual. Otherwise, it may cause an electric shock or damage the sensor. 	
 Plug and unplug properly	<ul style="list-style-type: none"> ● If abnormal smells, noises or smoke occur, or if liquid enters the instrument, pull out the AC adapter and remove the batteries immediately. Contact your distributor or the manufacturer for after service. Otherwise, there is possibility of electric shock, fire or instrument malfunction. 	

DANGER



Forbidden

- Do not expose the instrument to rain or water.
..... Otherwise, it may cause an electric shock, fire or injury.

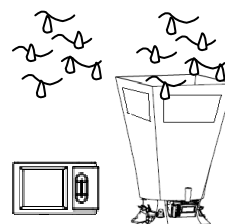

CAUTION



Using properly

- Always unplug the instrument when it is not in use.
..... Failure to do so may cause an electric shock, fire or circuit damage.



Using properly

- Remove the batteries when storing the instrument for a long period of time. Do not leave drained batteries in the battery compartment and exchange the batteries promptly when they are drained.

..... Failure to do so may cause battery leakage and damage to the instrument.



Using properly

- Only use the provided AC adapter.
.....Otherwise it may damage the instrument.



Forbidden

- Do not use or leave the instrument in a high temperature, high humidity or dusty environment. Do not leave the instrument under direct sunlight.

.....Otherwise, the instrument may not function properly or the inside components may be damaged.

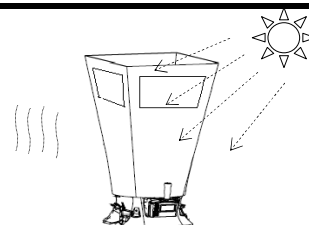

Forbidden

- Do not wipe the instrument with a volatile solvent.
.....The body may deform or deteriorate. Use a soft dry cloth to remove stains. If stains persist, soak the cloth in a neutral detergent and wipe the instrument with the soft cloth. Never use volatile solvents such as thinner or benzene.



Forbidden

- Never drop the unit or place heavy objects on it.
... It may cause damage or malfunction to the instrument.

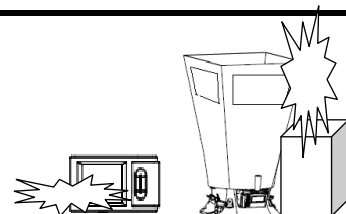

CONTENTS

1. Introduction.....	1
1.1 Product features.....	1
2. Capture Hood Structure.....	2
2.1 Instrument Base.....	2
2.2 Main structure.....	3
2.3 Fabric Hood.....	3
3. Installation and Assembling.....	3
3.1 Capture Hood Installation.....	3
3.2 Assembling the Frame (detail).....	4
3.3 Installing the Portable Handle.....	4
3.4 Installing the Main structure.....	5
4. Operation directions.....	5
4.1 Communication and Supplying Power with the AC Adapter.....	5
4.2 Supplying Power with Batteries.....	6
4.3 ON/OFF.....	7
4.4 Keypad Operation.....	7
4.5 Incline Adjustment Settings of the Instrument.....	8
4.6 Back Pressure Compensation On / Off Settings.....	9
4.7 Measuring.....	10
4.7.1 Start and enter into the main interface.....	10
4.7.2 Single Measurement Mode.....	10
4.7.3 Running Average Measurement Mode.....	11
4.7.4 Back Pressure Compensation Measurement Mode.....	12
5. Display Menu settings.....	12
5.1 Test Settings.....	13
5.1.1 Test ID setting.....	14
5.1.2 Test Mode settings.....	15

5.1.3 Set Units of Measure for Airflow, Temperature and Atmos	16
5.1.4 Actual flow, Standard flow settings	17
5.2 General Settings.....	18
5.3 Data processing settings.....	19
5.4 Communication settings.....	20
5.5 Print Settings.....	21
6.Main Specifications	23
7. Common Trouble Shooting.....	24
8. Warranty and After Service	25
8.1 Warranty	25
8.2 After Service.....	26

1. Introduction

The model 6710 is used to measure the air flow at the supply and the exhaust points of an HVAC system. There are several interchangeable hoods of various sizes so it's easy to find one that will match the size of the supply and exhaust points of any HVAC system.

The standard size hood is 2ft×2ft (610mm×610mm). Four additional sizes are also available as options:

- ◇ 2ft×4ft (610mm×1220mm).
- ◇ 1ft×4ft (305mm×1220mm).
- ◇ 2ft×3ft (610mm×915mm).
- ◇ 3ft×3ft (915mm×915mm).

The capture hood is designed to fit tightly over the air port to eliminate any leakage which could affect the accuracy of a measurement. Users can see the air port through the clear windows at the top of the capture hood ensuring it is lined up correctly. Fiberglass poles support the fabric hood.

A velocity matrix is fixed on the base and airflow is tested through sixteen measuring points on the cross sections of the matrix. The sensor will measure airflow and correct for air pressure and temperature ensuring an accurate reading every time.

1.1 Product features

- Measure air flow, temperature and humidity at the same time
- Two kinds of tests are available for supply flow and exhaust flow
- Wide test range: 40~4300 m³ /h
- Large Storage capacity: 3000 records
- 3.5 inch color LCD
- LCD tilts up to 30° for easy viewing
- Back pressure compensation
- Automatic air pressure and temperature correction
- Light weight, compact configuration for easy transportation

2. Capture Hood Structure

The capture hood consists of a fabric hood, main structure and an instrument base. The structural drawing is below:

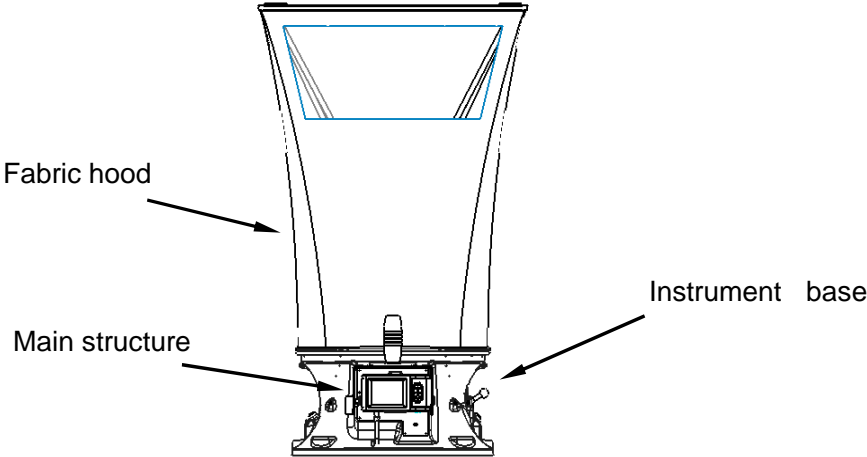

2.1 Instrument Base

1) The exterior structure of the base as below: 2) The internal structure of the base as below:

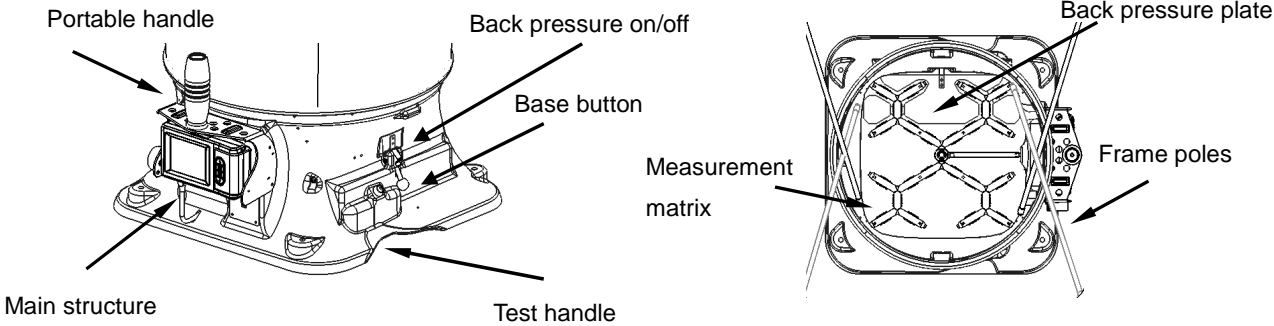

3) Matrix

There are sixteen measuring points for testing air flow.

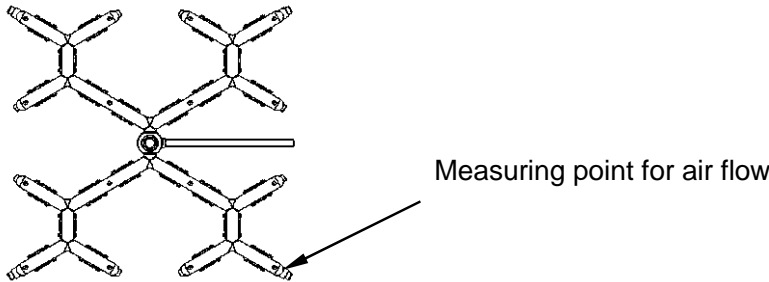

2.2 Main structure

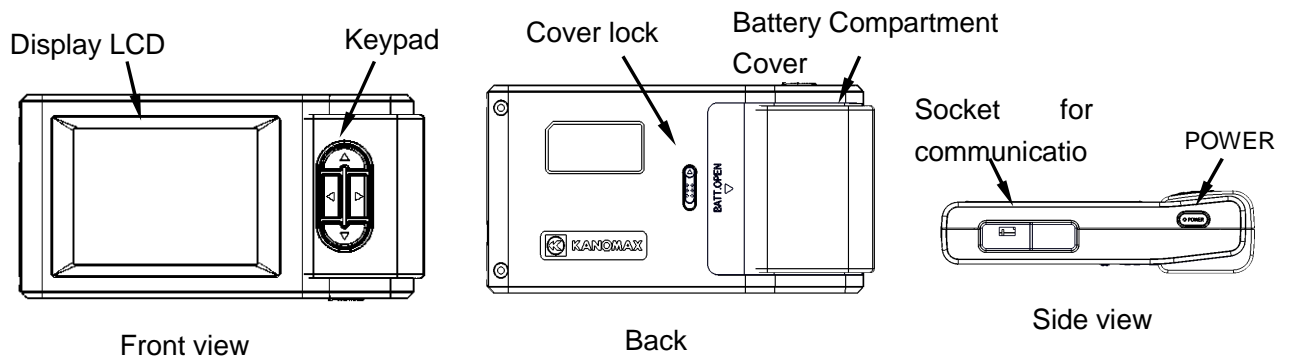

2.3 Fabric Hood

The fabric hood kit consists of a frame, and a fabric hood with four windows as shown below:

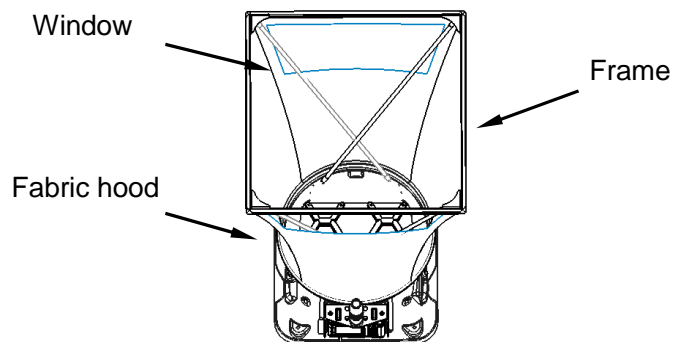

3. Installation and Assembling

3.1 Capture Hood Installation

1) Assemble the fabric hood and the frame as shown below:

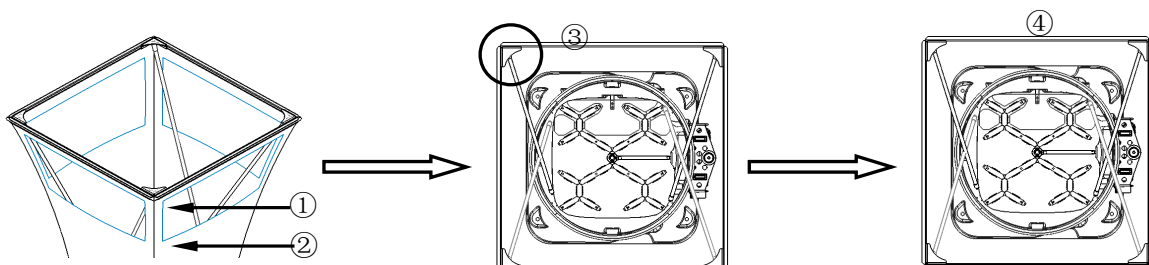

Use the angled corners ① and the stitching ② as a guide to ensure the hood is straight. If the fabric hood is twisted it will not assemble correctly.

Insert a frame pole into the frame and hook it under the corner of the hood ③.

Continue until all 4 corners are supported by poles ④.

- 2) The figures below are provided as a reference.
- Use the mark ① and the stitching as a guide to ensure the hood position.
 - Make sure the hood fully wraps around the base.

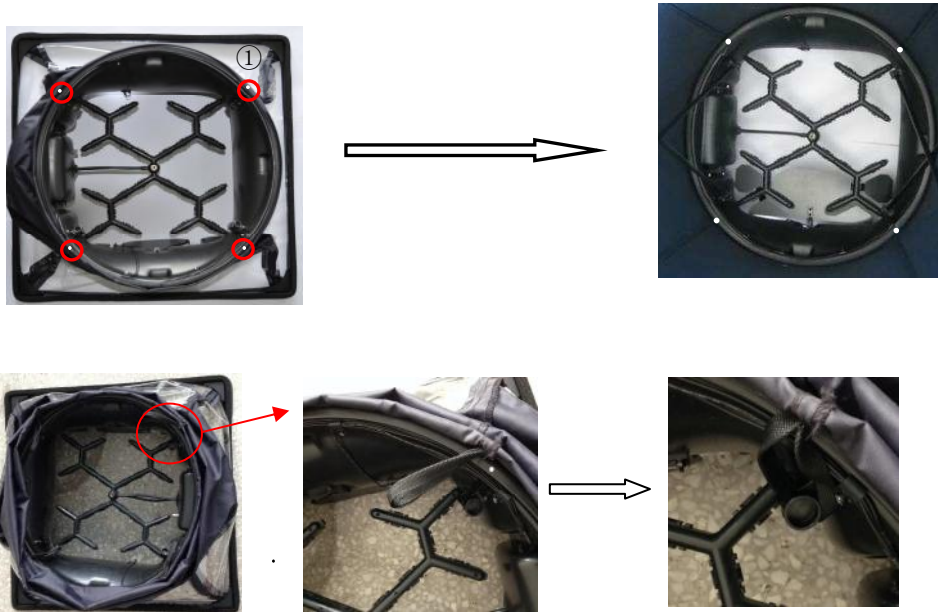

3.2 Assembling the Frame (detail)

Insert one end of a support pole into its pole mount in the base as in figure ① and the other end into the frame corner as in figure ②. For the positions of the remaining 3 poles refer to figure ③, and repeat the steps as above.

Note: The support poles always cross in an “X” shape when the hood is assembled. To remove the poles, simply reverse the steps.

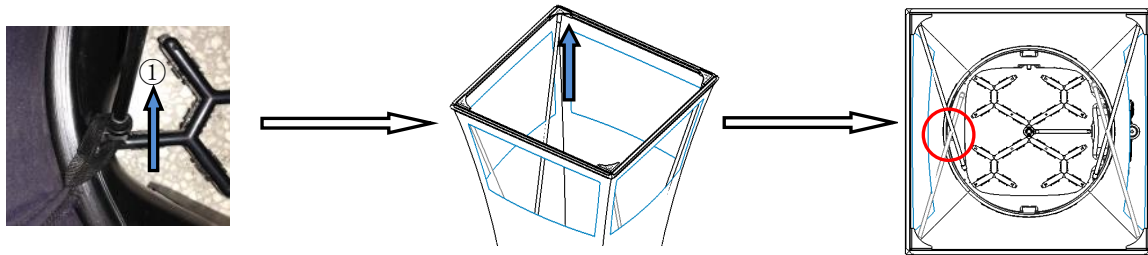

3.3 Installing the Portable Handle

To install the handle line it up with the mounting hole as shown in step ① and ② below. Step ③ shows the handle installed.

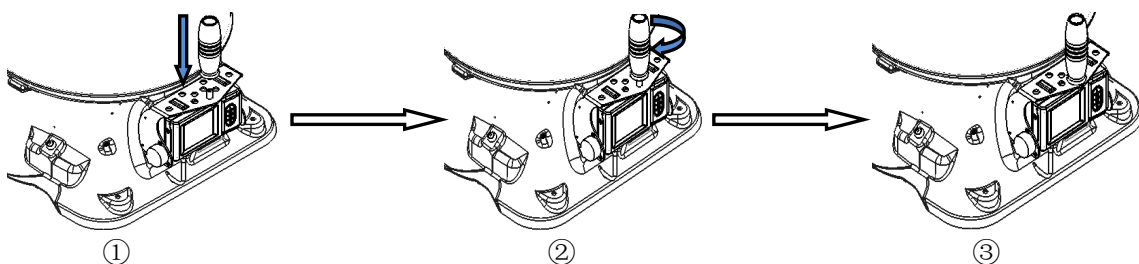

Note: The support poles and the portable handle should be disassembled before packing the capture hood in the carrying case to avoid damaging the case.

3.4 Installing the Main structure

To install the Main structure ①, set the bottom of the panel in the holder on the unit base ② and gently push the top of the panel backwards ③ until it locks into place. To remove it, simply reverse the procedure.

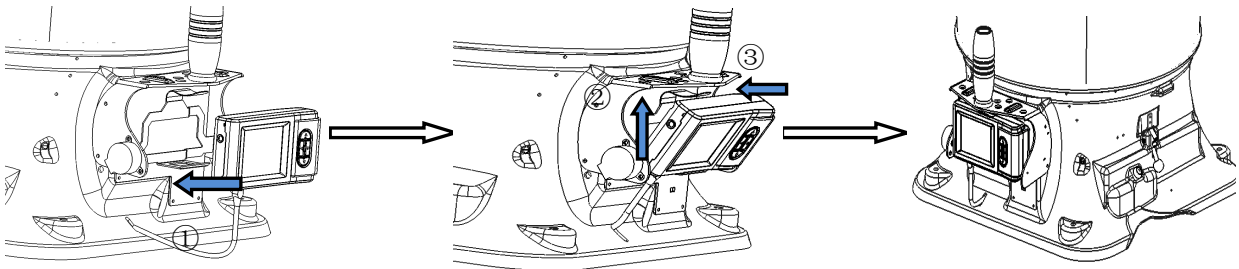

4. Operation directions

4.1 Communication and Supplying Power with the AC Adapter

Connect the main structure to a PC (refer to figure ①).

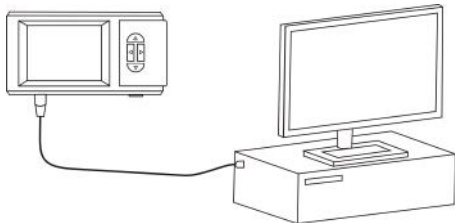

① The main structure is connected to a PC.

To power the instrument with the optional AC adapter, refer to figures ② and ③. When the AC adapter is connected and batteries are installed, power will be supplied from the AC adapter.

The specification of the AC adapter is: I/P: AC 110-240V 50/60 HZ O/P: DC 5V/ 2A

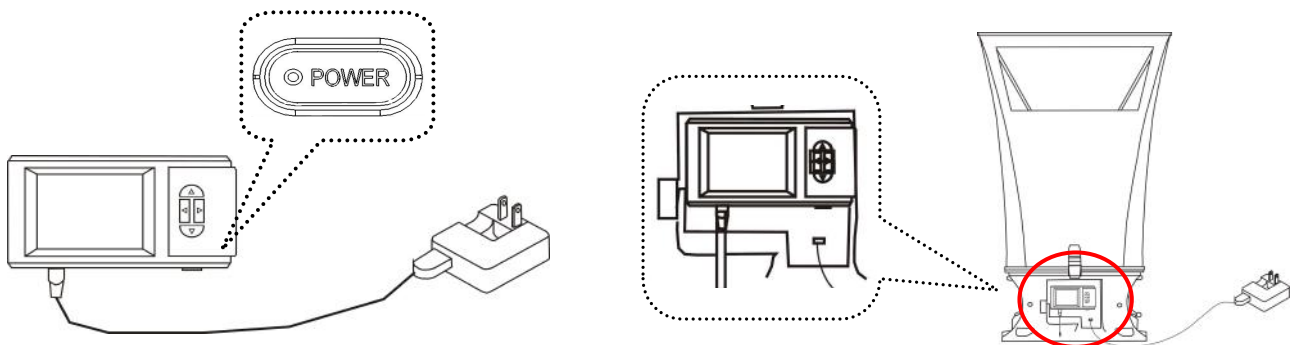

②The AC adapter supplies power for the main structure. ③The AC adapter also supplies power for the Capture hood.

4.2 Supplying Power with Batteries

- 4 AA-size batteries can be used for a power supply.
- Press the compartment cover lock (refer to figure ①), and then slide the cover off to open the battery compartment.
- Put 4 AA-size batteries in and make certain the batteries are correctly oriented.
- New alkaline battery or rechargeable Ni-MH battery can be used. Never mix battery types, or battery leakage or damage to the instrument may occur.
- Replace the compartment cover (refer to figure ②). The compartment cover will be automatically locked.

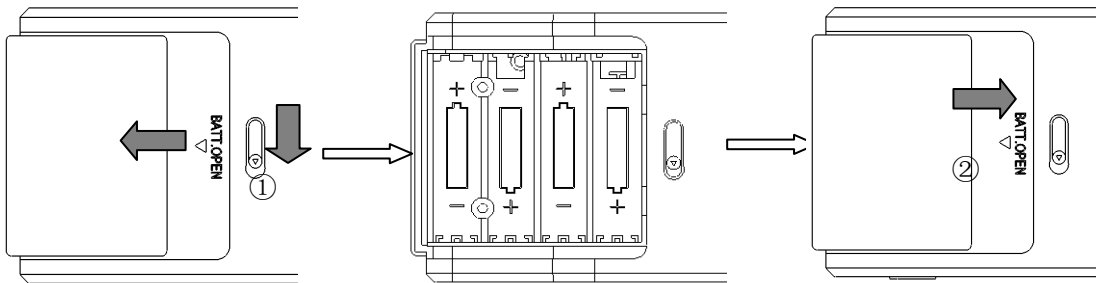

- When power is supplied with batteries, the current charge value will be displayed on the upper of the LCD. When the batteries run out of power, the instrument will turn off.

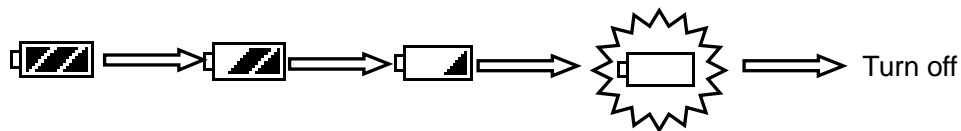

1. You can't begin a new test.

2. You can't use the incline adjustment settings of the instrument.

3. The test may stop if the battery is low during testing.

4. The adjustment settings of the instrument may stop when the battery is low during adjustment.

Note:

1. Don't use a full power battery with low power batteries.

2. It is recommended you change batteries when the power shows low.

4.3 ON/OFF

1. Getting started

The LCD is displayed below for reference:

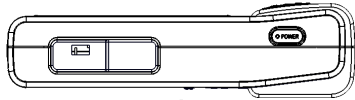

(1) Press **【POWER】** for a while.

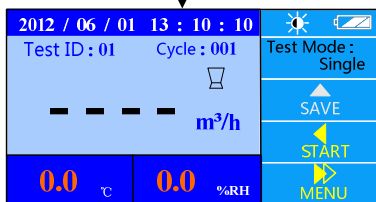

(2) Then you enter into the main interface as shown in the left figure.

2. Shut down

Press and hold **【POWER】** for more than 2 seconds in any mode, and the instrument will turn off automatically.

4.4 Keypad Operation

Keypad operations include the keypad on the control panel as well as the switches on the base.

The keypad on the control panel is shown below. When a keypad turns gray in the illustration on the screen, that particular function is invalid.

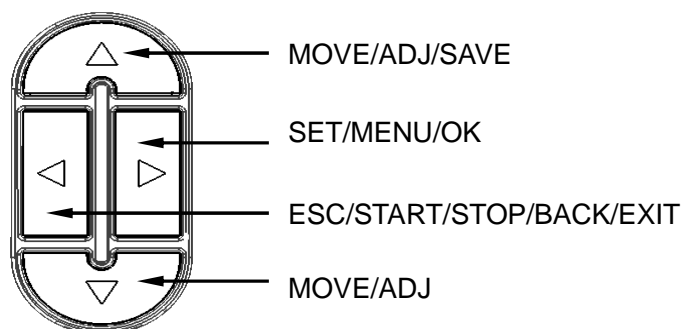

- MOVE: Change an option on the current mode.
- ADJ: Change the current value.

- **SAVE:** Save the current test results.
- **SET:** Store changes or enter into the selected option's next level interface.
- **MENU:** On the main screen holding this down for 2 seconds will enter into the main "MENU".
- **OK:** Pressing for 2 seconds will save the date or time in the "General Settings", Pressing for 2 seconds will delete saved data in the "Record Processing".
- **START:** Begin a measurement in main menu.
- **STOP:** Stop a measurement in main menu.
- **BACK:** Cancel or end an operation or return to the previous screen.
- **EXIT:** Return to the main menu.
- **ESC:** Stop printing when printing.

Left / right switches on the base

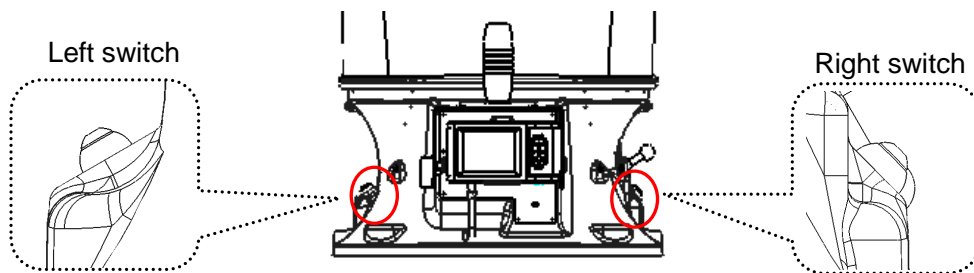

Left switch on base

Press it once quickly to start or stop a measurement. Press and hold it in for at least 3 seconds to tilt the control panel and LCD screen downward.

Right switch on base

Press it once quickly to save the current data. Press and hold it in for at least 3 seconds to tilt the control panel and LCD screen upward.

4.5 Incline Adjustment Settings of the Instrument

Start up the instrument and lift the capture hood to the approximate height you will be working at. Press and hold the left button on the base to tilt the panel downward, or press and hold the right switch to tilt it up. The buttons must be held down for a minimum of 3 seconds before the panel will begin to tilt. While the panel is moving, you will hear an audible buzzing.

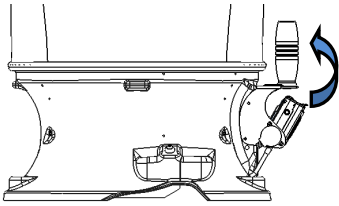

Right switch makes the panel tilt up.

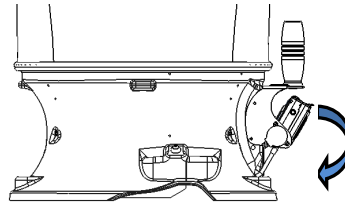

Left switch makes the panel tilt down.

Note:

- 1. The instrument may turn off, when you attempt to adjust the incline settings of the instrument if the battery display is at .**
- 2. You can't adjust the incline settings of the instrument when testing or if you're not in the main interface.**
- 3. To conserve power, avoid tilting the screen unless necessary.**

4.6 Back Pressure Compensation On / Off Settings

Turn the Back Pressure Compensation ON: Flip the switch ① to the down position until it is locked. Make the back pressure plate parallel with the matrix plane.

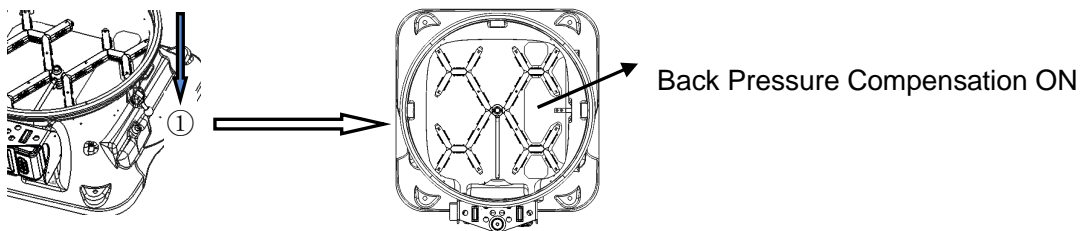

Turn the Back Pressure Compensation OFF: Flip the switch ① to the up position until it is locked. Make the back pressure plate vertical against the matrix plane.

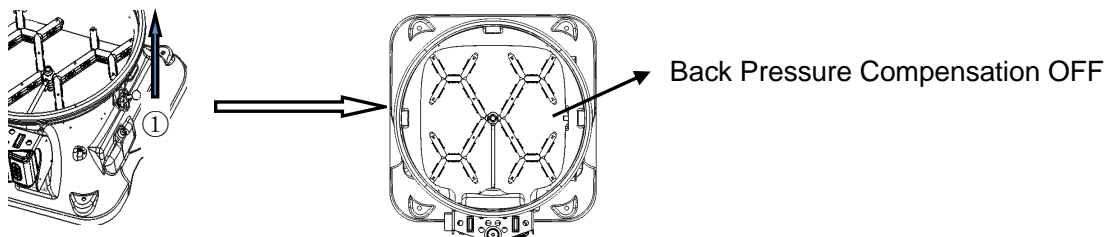

4.7 Measuring

4.7.1 Start and enter into the main interface

To start measuring, go to the main interface menu as shown below:

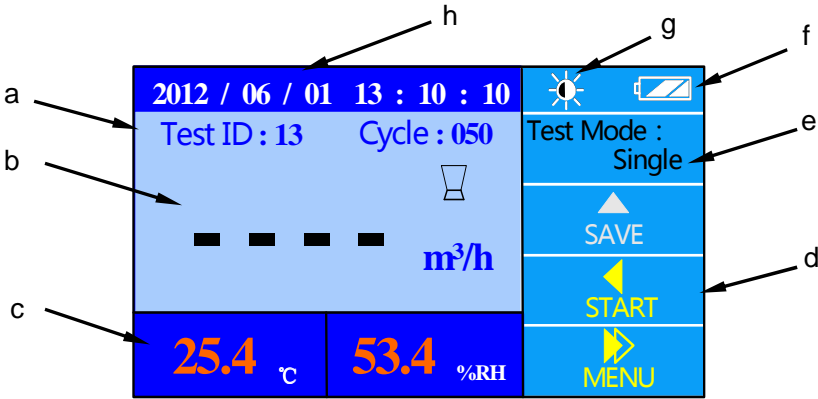

- a. Test ID, Cycle——save the testing No. in Cycle and the corresponding Test ID.
- b. Air flow display ——display the testing data of air flow.
- c. Temperature, Humidity ——display the current temperature and humidity in real time.
- d. Keypad function ——display the function of the keys in the current interface.
- e. Test mode ——display the current testing mode: Single measurement, Run Avg measurement and B.Press measurement.
- f. Power supply mode ——display the current power supply from the AC adapter or the batteries.
- g. Brightness indicator ——display the current brightness of the LCD.
- h. Date, Time ——display the current date and time.

Note: When “Act” is selected in the following three measurement modes, please change the atmosphere Pressure setting in 5.1.4.

4.7.2 Single Measurement Mode

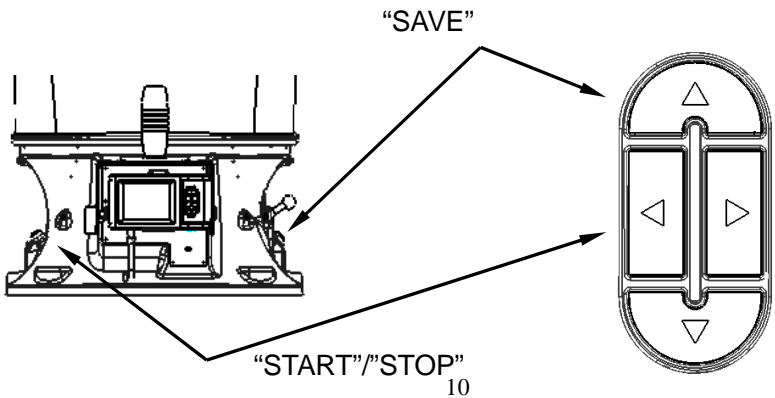

- 1) “Single” measurements are individual flow measurements. When you press “START”, the instrument will begin measuring and the air flow value will be displayed as “- - -”.
- 2) The test will stop automatically when the air flow is stable and a flow value with the corresponding wind direction will be displayed. Air flow will be stable within 8 seconds. The greater the air flow the shorter the time needed to stabilize.
- 3) After the measurement stops, press “SAVE” to record the testing value, if you do the “Cycle” No. will increase by 1.

Note: The value will be recorded only when testing is completed in the “Single” mode. If testing is interrupted before a stable airflow reading is displayed no data will be saved.

4.7.3 Running Average Measurement Mode

- 1) When “Run Avg” mode is selected, the instrument will constantly measure and display a running average. Press “START” to begin the measurement.
- 2) During the test if the air flow is not stable, the flow reading will display “- - -”, then once the reading has stabilized a flow reading will be obtained and displayed every 1 second, and the wind direction will be displayed in real time.

Note: The displayed air flow reading is a running average that is calculated based on the “Avg Time” settings entered by the user. The greater the “Avg Time” the more stable the tested air flow.

- 3) When auto-save is enabled, the testing flow values will be recorded at user-defined intervals under the setting “Save Time”, and the “Cycle” No. will increase by 1. If auto-save is not enabled the readings will not be saved during the test.
- 4) The instrument will run continuously in “Run Avg” mode until you press “STOP”. After you press stop, the last reading and the related wind direction will be displayed. Press “SAVE” to record the testing value, if you do the “Cycle” No. will increase by 1.

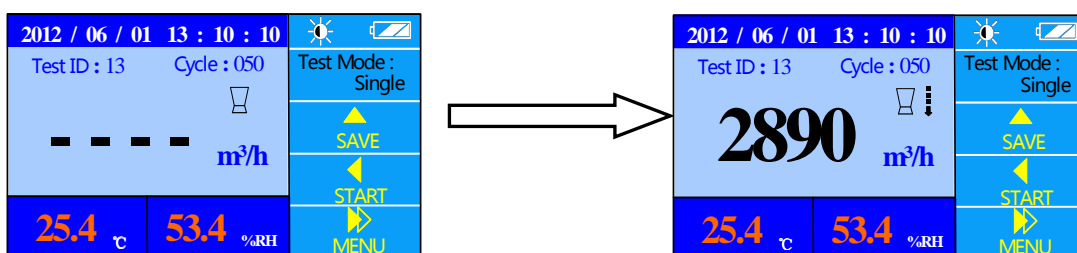



4.7.4 Back Pressure Compensation Measurement Mode

When measuring air flow in an environment with a strong wind or turbulent flow, it will produce resistance for test air flow and system pressure. **It is suggested you turn the Back Pressure Compensation ON when the air flow is more than 1500 m³/h, otherwise you can test without the Back Pressure Compensation ON.**

- 1) When "B. Press" mode is turned on, press "START" and the measurement will begin.
- 2) When "Flap Open!" is displayed, close the Back pressure plate and press "START" to start the measurement.
- 3) When the measurement stops, the air flow, as measured with Back Pressure Compensation will be displayed.
- 4) After the measurement stops, press "SAVE" to save the data and the "Cycle" No. will increase by 1.

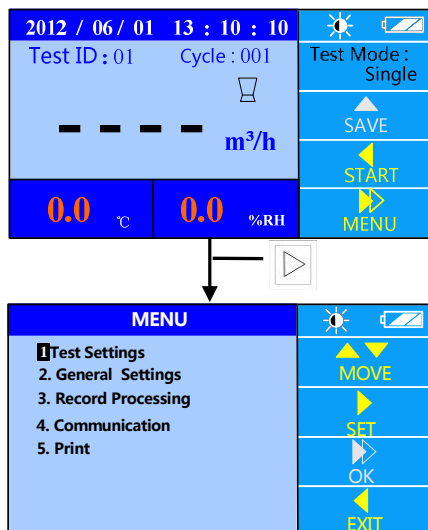
5. Display Menu settings







(1) In the main interface, press  for 2 sec to enter into "MENU".

(2) There are 5 option items in "MENU":

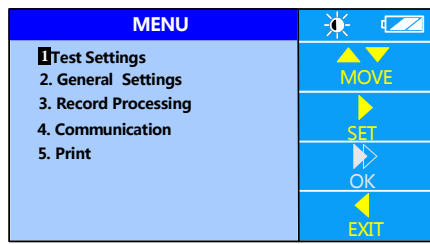
1. Test Settings
2. General Settings
3. Record Processing
4. Communication
5. Print

5.1 Test Settings



(1) Press  or  to select “Test Settings”, and press  to enter into “Test Settings”. Press  return to the main interface.

(2) The option items in “Test Settings” are as follows:

1. Test ID
2. Test Mode
3. Unit
4. Act. Std (Actual / Standard air flow setting)

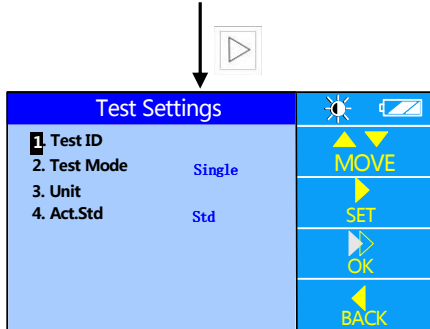

5.1.1 Test ID setting

A Test ID consists of a group of Cycles (or Samples). A Test ID can contain up to 100 Cycles. The maximum number of Test IDs is 30. Any new Sample will be saved to the current Test ID. You can change the current Test ID at any time to keep your data organized. Press  to return to the "MENU" and the settings will not be saved. Refer to the figures as below:

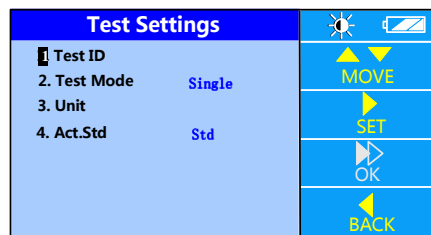

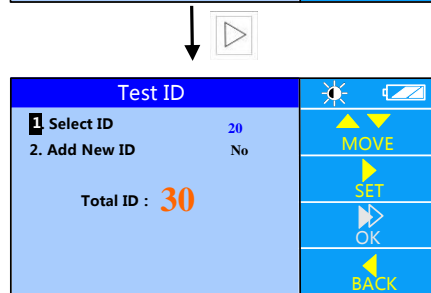

➤ Under "Test Settings", press  or  to choose option item 1 "Test ID".

➤ Press  to change the "Test ID" setting.





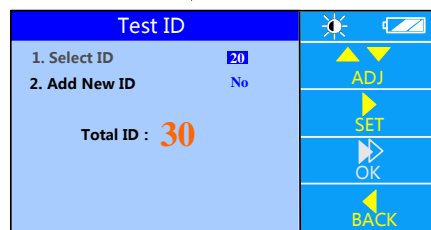

➤ Press  or  to select a menu item.

➤ Press  to enter a setting.

Under option 1, press .





➤ Press  or  to increase or decrease the Test ID No.

➤ Press  for save your changes, or press  to quit.

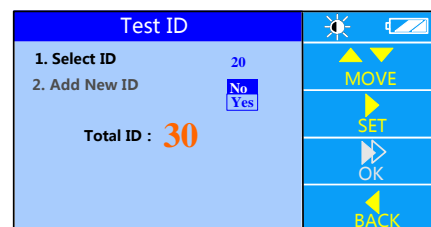
Under option 2, press .



➤ Press  or  change the settings.

➤ Press  to save your changes, or press  to quit.

5.1.2 Test Mode settings

This setting is for change the test mode & the settings about the test modes. Refer to the steps below:

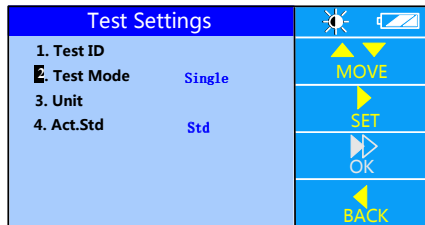

➤ Under “Test Settings”, press or to select 2 “Test Mode”.

➤ Press to enter into the “Test Mode” setting.

➤ Press to return to “MENU”.

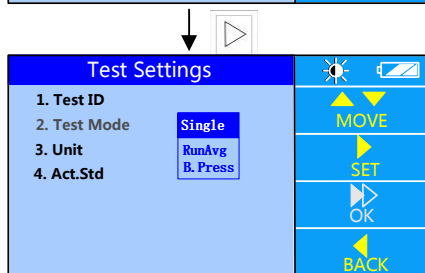

➤ Press or to change the selected item as shown below.

➤ Press to save or press to go back without saving.

Under option “Single”, press . Single → RunAvg → B. Press

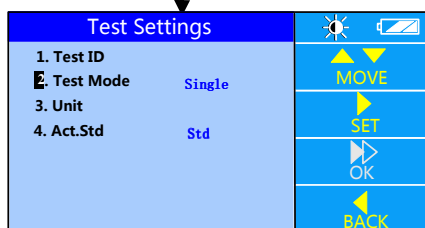

Under option “Run Avg”, press .

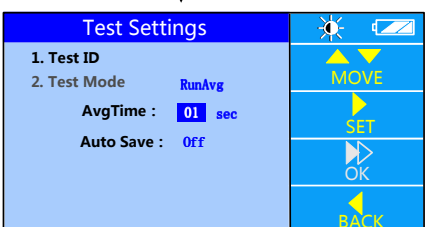

➤ When “Run Avg” is selected, “Save Time” and “Auto Save” must be set.

➤ Press or change the “Avg Time” value.

➤ Press to save or press to quit.

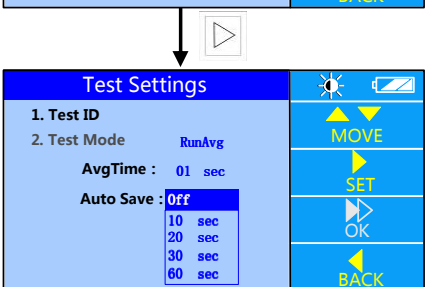

➤ Press or to change the selected item as shown below.

➤ Press to save or press to go back without saving.

Off → 10sec → 20 sec → 30sec → 60 sec

Under option “B.Press”, press .

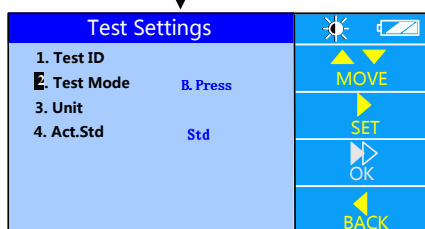

5.1.3 Set Units of Measure for Airflow, Temperature and Atmos

For available units, refer to the below chart:

Display shows	Available units
Air flow	m ³ /h, CFM, l/s
Temperature	°C, °F
Atmos	kPa, inHg

To change the units of measure, follow these steps:

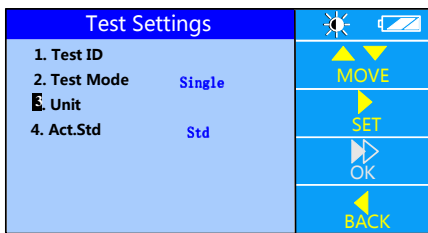

- Under “Test Settings”, select the option 3 “Unit”.
- Press enter to the “Unit” settings or press to return to “MENU”.

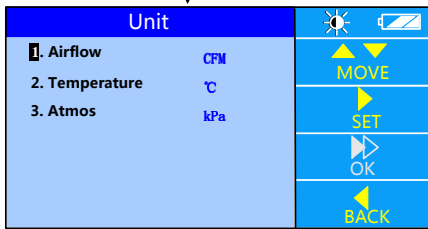

- Press or to select option item 1, 2 or 3.
- Press to change the selected item.

Under option 1, press .

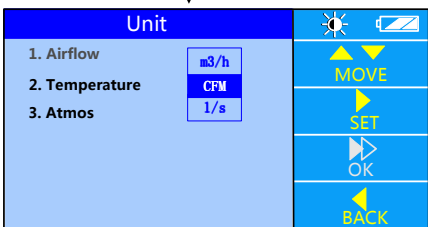

- Press or to change the selected unit as shown below:
- Press to save or press to quit.

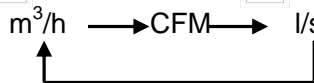

Under option 2, press .

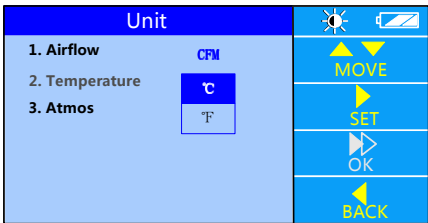

- Press or to change the selected unit as shown below:
- Press to save or press to quit.

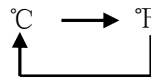

Under option 3, press .

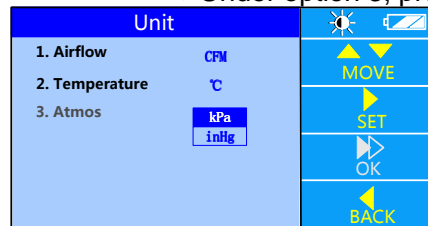

- Press or to change the selected unit as shown below:
- Press to save or press to quit.

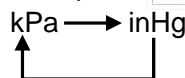

5.1.4 Actual flow, Standard flow settings

This setting is for selecting Actual air flow [ACT] or Standard air flow [STD].

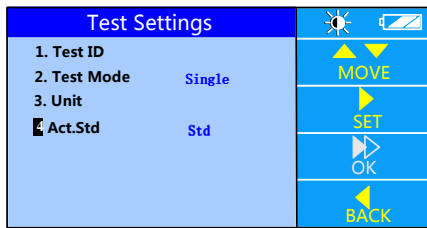

- Under the “Test Settings”, select option 4 “Act. Std”.
- Press to enter or press to return to “MENU”.

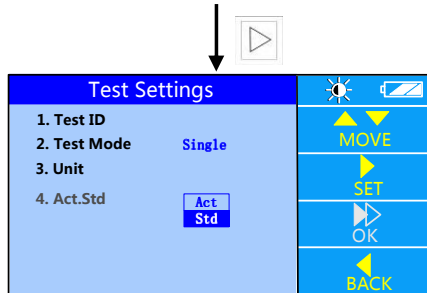

- Press or to change the settings as shown below.
- Press to save the changes or press to quit.

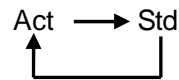

Under option “Std”, press .

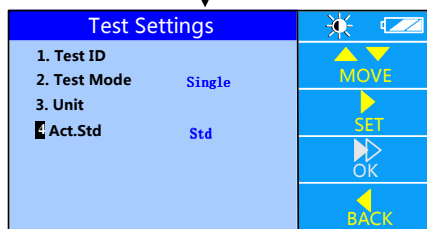

Under option “Act”, press .

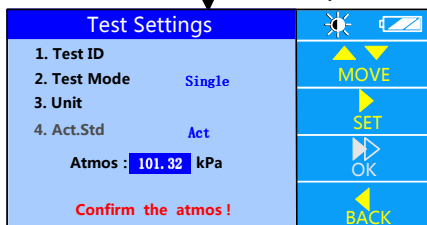

- When “Act” is selected, “Atmos” must be set.
- Press or to change the Atmos.
- Press to save the changes or press to quit.

5.2 General Settings

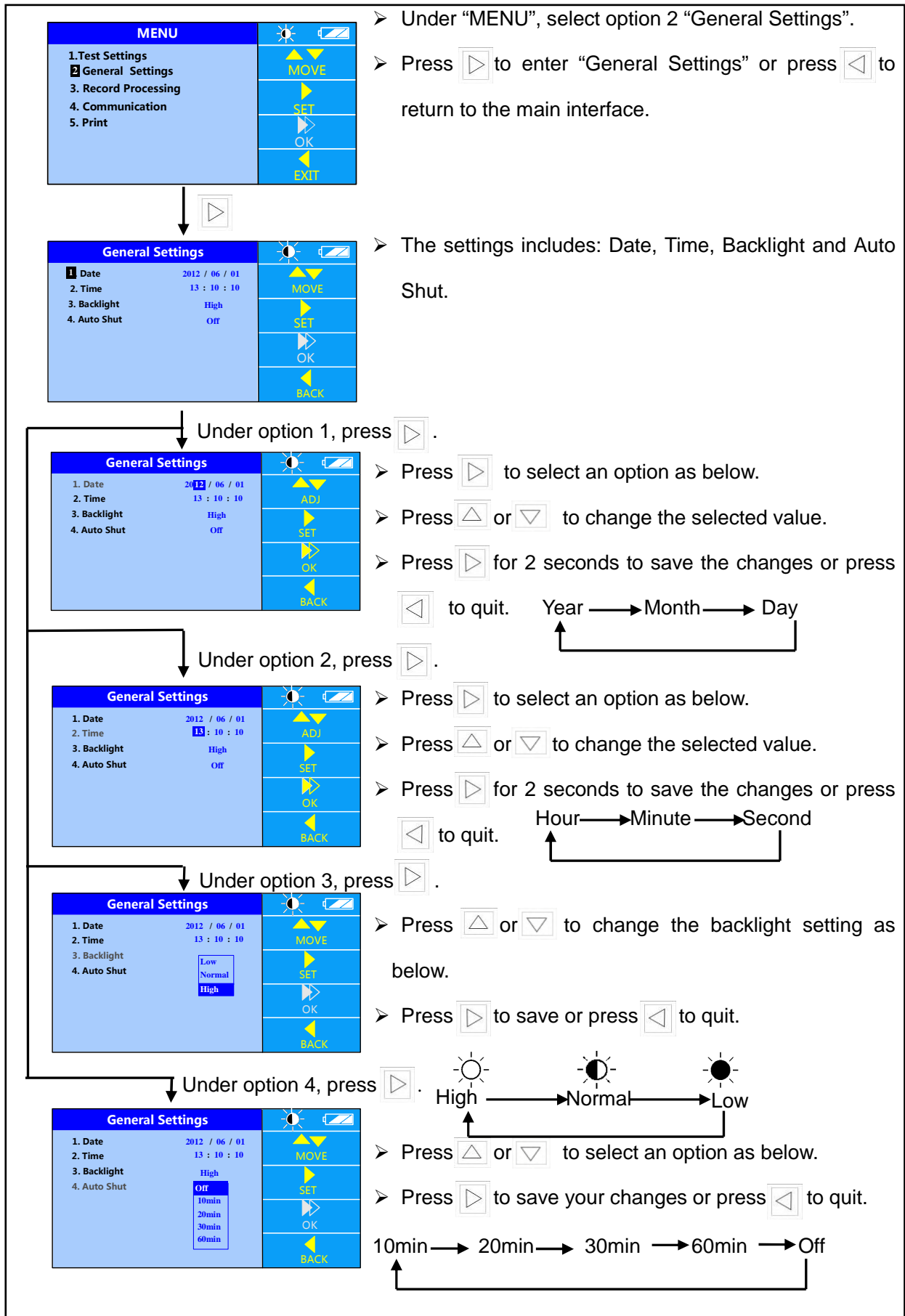

5.3 Data processing settings

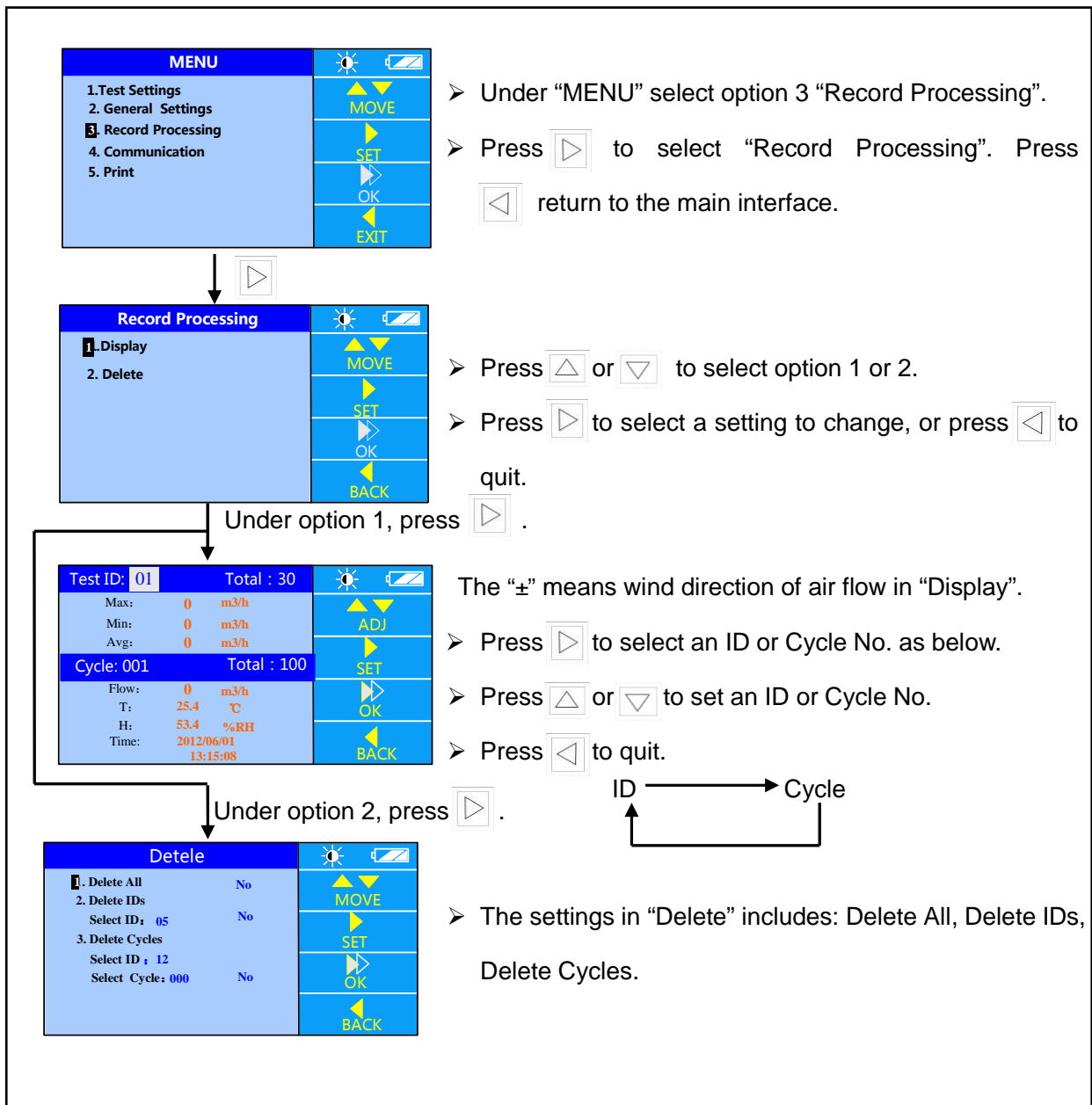

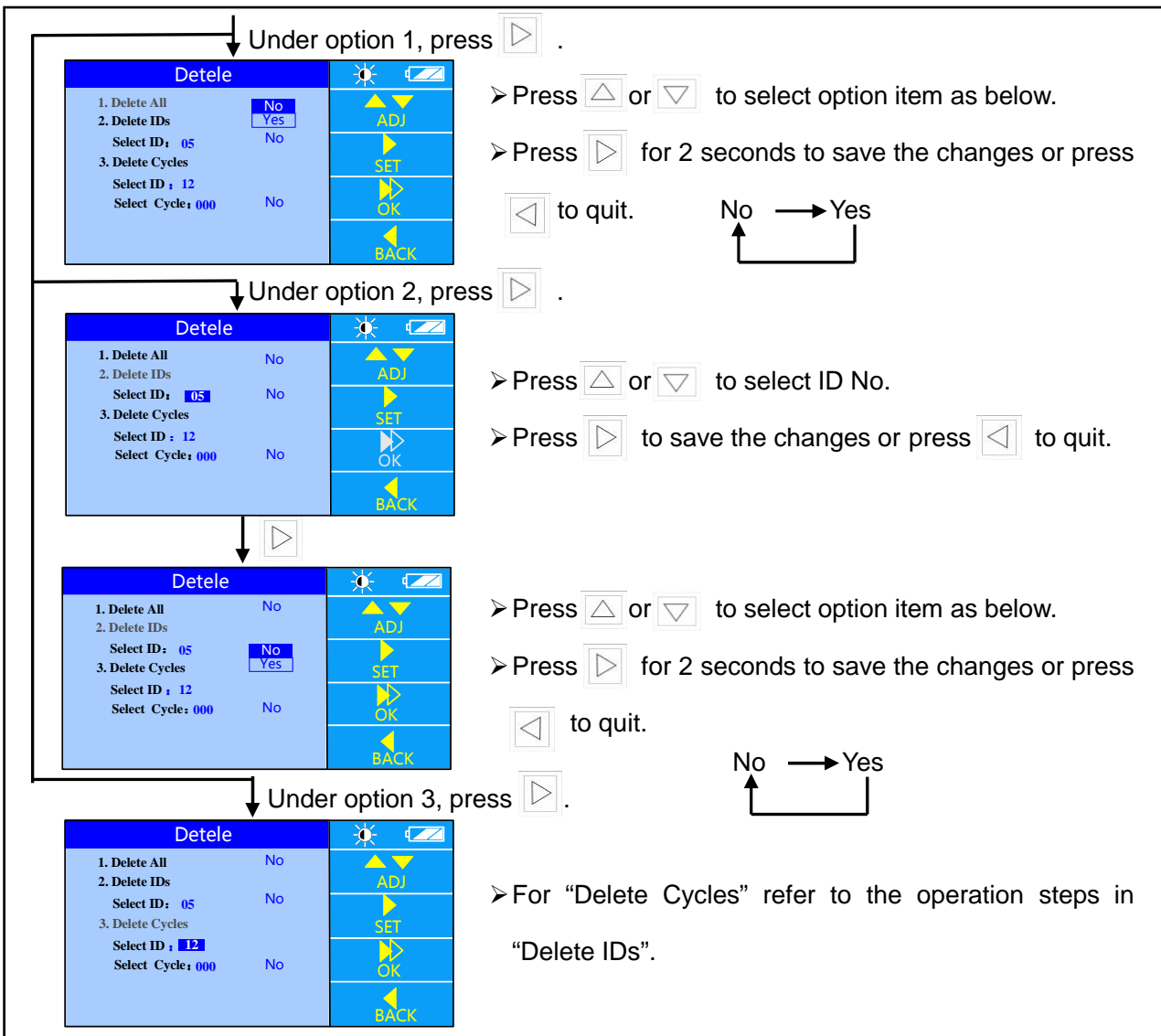

5.4 Communication settings

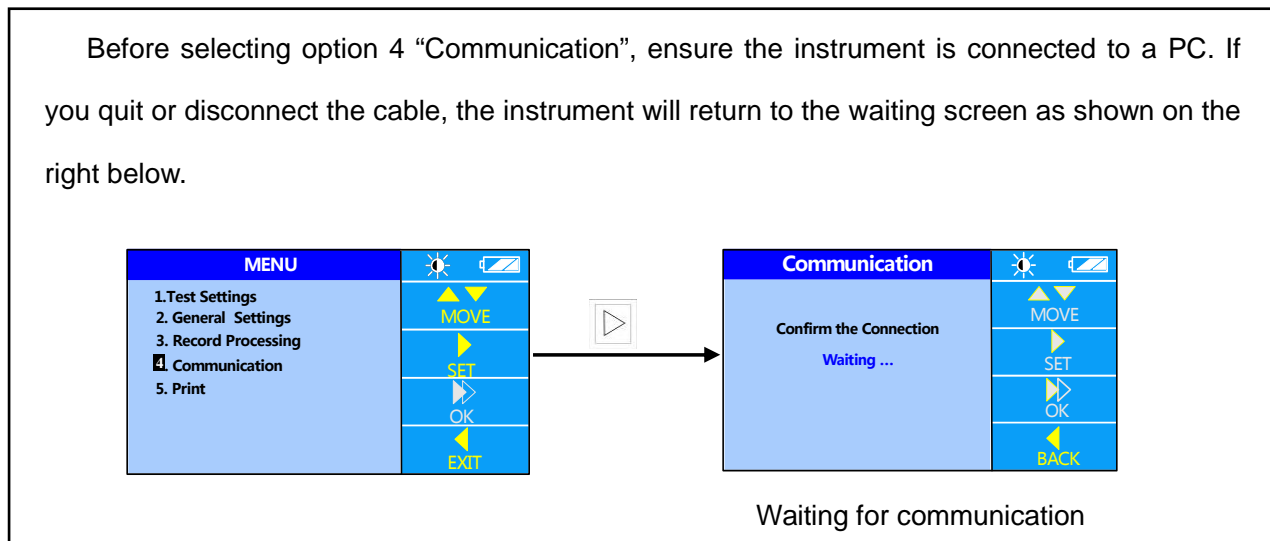



5.5 Print Settings

Note: Before printing ensure the following:

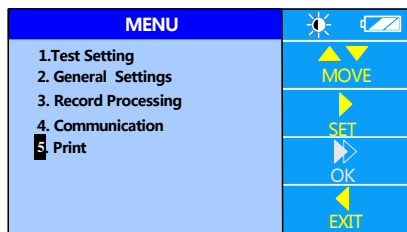
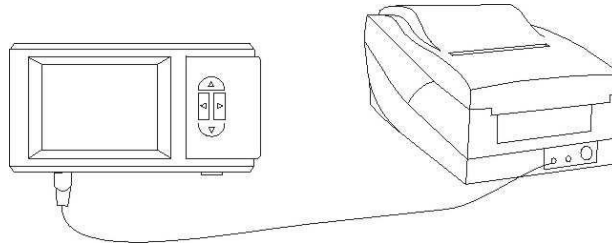
1. Please select the factory configuration printer and printer cable. For details, refer to the printer manual <<RD series of mini-printer>>.
2. Baud Rate is set to 19200. The initial value is set to 19200.



➤ Under "MENU", select option 5 "Print".

➤ Press  to select "Print" or press  return to the main interface.

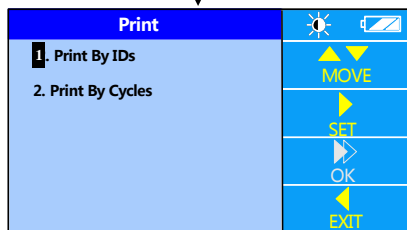

➤ The setting in "Print" includes: Print By IDs, Print By Cycles.

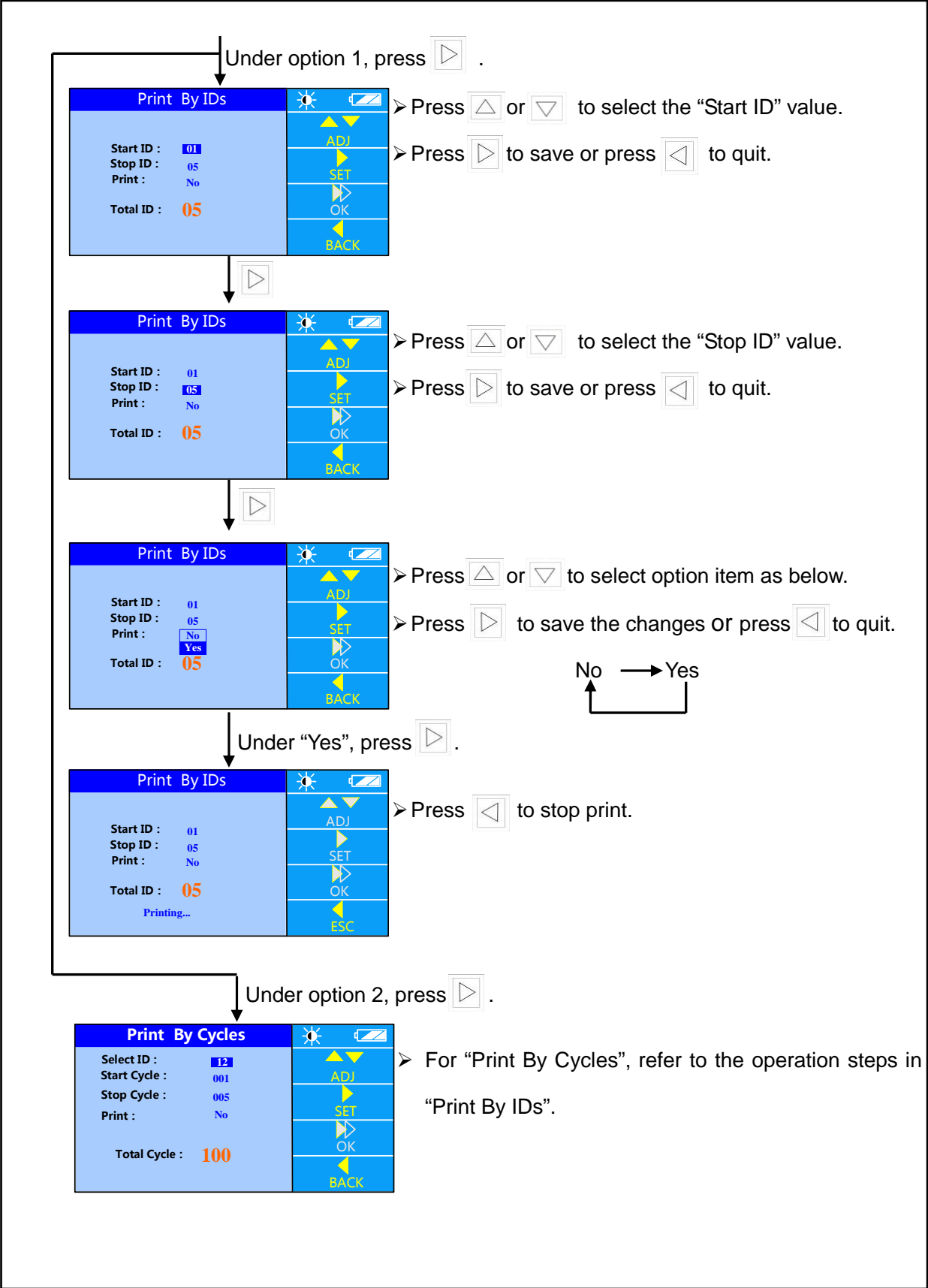

6.Main Specifications

Items		6710 version 2
Air Flow	Flow range	40~4300 m ³ /h
	Accuracy	Readings $\pm 3\% \pm 8$ m ³ /h (Air Flow > 85 m ³ /h)
	Resolution	1 m ³ /h
Temperature	Temperature range	0~60°C
	Accuracy	± 0.5 °C (within 5~40°C ± 0.3 °C)
	Resolution	0.1°C
Humidity	Humidity range	0~100%RH
	Accuracy	$\pm 3\%$ RH (10~90%RH)
	Resolution	0.1%RH
Operating Temperature range		0~60°C (no condensing)
Storage Temperature range		-20~70°C (no condensing)
Atmos. Correction		Yes
Back Pressure Compensation		Yes
Data record		3000
Data Transmission		Data Statistics (Max, Min, and Avg) ; Check and Delete; Connect with PC (USB) and the Printer
Hood Size	Standard	2ftx2ft (610mmx610mm)
	Optional	2ftx4ft (610mmx1220mm), 1ftx4ft (305mmx1220mm), 2ftx3ft (610mmx915mm), 3ftx3ft (915mmx915mm)
Power Source		AC/DC Power; or Rechargeable batteries for 9 hours
Weight		Approx. 3.5kg
Standard attachment		Instrument Base, 2ftx2ft (610mmx610mm) fabric hood, Frame poles, User Manual, Communication cable, Software Installer, Carrying case and Main structure
Optional		Fabric hood: 2ftx4ft (610mmx1220mm), 1ftx4ft (305mmx1220mm), 2ftx3ft (610mmx915mm), 3ftx3ft (915mmx915mm), Frame Poles, Printer, Cable, Up-down Stand (max:3m) , and AC adapter

7. Common Trouble Shooting

Symptom	Possible causes / troubleshooting
No display	Check the positive/negative connections of the batteries. →Verify the batteries are inserted correctly.
	Low battery charge. →Replace or recharge the batteries.
Main structure cannot be adjusted	Low battery charge. →Replace or recharge the batteries.
	A test is running. →Stop the test, adjust the incline settings of the instrument again.
	Check the interface. →Return to the main interface.
“DATA Error” after test in B. Press mode	Flap closed pressure was less than flap open pressure, or flap open versus flap closed pressure ratio exceeds allowed limits. →Test again.
Test data was not saved after testing	The Cycle is full in the current ID. →Add a new ID.
A new ID cannot be added	The current ID is already a new ID. →Use the current ID.
	Check the ID No. →If the ID No is 30, delete some IDs.
Print appears garbled	Baud rate does not match. →Set Baud again.
Display “Connect Error”	Check the connection between the instrument and the cable. →Connect the cable again and restart.
The test does not begin after pressing “START”	Check the connection between the instrument and the cable. →Check the cable, and connect again.
	Low battery charge. →Replace or recharge the batteries.
	The instrument is being adjusted. →Stop adjusting the instrument.
	Check the back pressure plate. →Close the Back pressure plate.
Test exception when testing	Check the connection between the instrument and the cable. →Check the cable, and connect again.
Abnormal operation of the solenoid valve when testing	Check the connection between the instrument and the cable. →Check the cable, and connect again.
Motor movement disorders when testing	Check the connection between the instrument and the cable. →Check the cable, and connect again.

8. Warranty and After Service

8.1 Warranty

The limited warranty set forth below is given by KANOMAX GROUP COMPANIES with respect to the KANOMAX brand capture hood and other accessories (hereafter referred to as “PRODUCT”) purchased directly from KANOMAX GROUP COMPANIES or from an authorized distributor.

Your PRODUCT, when delivered to you in new condition in its original container, is warranted against defects in materials or workmanship as follows: for a period of one (1) year from the date of original purchase, defective parts or a defective PRODUCT returned to KANOMAX GROUP COMPANIES, as applicable, and proven to be defective upon inspection, will be exchanged for a new or comparable rebuilt parts, or a refurbished PRODUCT as determined by KANOMAX GROUP COMPANIES. Warranty for such replacements shall not extend the original warranty period of the defective PRODUCT.

This limited warranty covers all defects encountered in normal use of the PRODUCT, and does not apply in the following cases:

- (1) Use of parts or supplies other than the PRODUCT sold by KANOMAX GROUP COMPANIES, which cause damage to the PRODUCT or cause abnormally frequent service calls or service problems.
- (2) If any PRODUCT has its serial number or date altered or removed.
- (3) Loss of damage to the PRODUCT due to abuse, mishandling, alternation, improper packaging by the owner, accident, natural disaster, electrical current fluctuations, failure to follow operation, maintenance or environmental instructions prescribed in the PRODUCT's operation manual provided by KANOMAX GROUP COMPANIES, or service performed by other than KANOMAX GROUP COMPANIES.

NO IMPLIED WARRANTY, INCLUDING ANY IMPLIED WARRANTY OF MERCHANTABILITY OR FITNESS FOR A PARTICULAR PURPOSE, APPLIES TO THE PRODUCT AFTER THE APPLICABLE PERIOD OF THE EXPRESS LIMITED WARRANTY STATED ABOVE, AND NO OTHER EXPRESS WARRANTY OR GUARANTY, EXCEPT AS MENTIONED ABOVE, GIVEN BY ANY PERSON OR ENTITY WITH RESPECT TO THE PRODUCT SHALL BIND KANOMAX GROUP COMPANIES. KANOMAX GROUP COMPANIES SHALL NOT BE LIABLE FOR LOSS OF STORAGE CHARGES, LOSS OR CORRUPTION OF DATA, OR ANY OTHER SPECIAL, INCIDENTAL OR CONSEQUENTIAL DAMAGES CAUSED BY THE USE OR MISUSE OF, OR INABILITY TO USE, THE PRODUCT, REGARDLESS OF THE LEGAL THEORY ON WHICH THE CLAIM IS BASED, AND EVEN IF KANOMAX GROUP COMPANIES HAS BEEN ADVISED OF THE POSSIBILITY OF SUCH DAMAGES. IN NO EVENT SHALL RECOVERY OF ANY KIND AGAINST KANOMAX GROUP COMPANIES BE GREATER IN AMOUNT THAN THE PURCHASE PRICE OF THE PRODUCT SOLD BY KANOMAX GROUP COMPANIES AND CAUSING THE ALLEGED DAMAGE. WITHOUT LIMITING THE FOREGOING, THE OWNER ASSUMES ALL RISK AND LIABILITY FOR LOSS, DAMAGE OF, OR INJURY TO THE OWNER AND THE OWNER'S PROPERTY AND TO OTHERS AND THEIR PROPERTY ARISING OUT OF USE OR MISUSE OF, OR INABILITY TO USE, THE PRODUCT NOT CAUSED DIRECTLY BY THE NEGLIGENCE OF KANOMAX GROUP COMPANIES. THIS LIMITED WARRANTY SHALL NOT EXTEND TO ANYONE OTHER THAN THE ORIGINAL PURCHASER OF THE PRODUCT,

OR THE PERSON FOR WHOM IT WAS PURCHASED AS A GIFT, AND STATES THE PURCHASER'S EXCLUSIVE REMEDY.

8.2 After Service

- When you have a problem with your instrument, please check out the “Common Trouble Shooting” section first.
- If that does not help, please contact your local distributor, or contacts on the last page.
- During the warranty period, we will repair at no charge a product that proves to be defective due to material or workmanship under normal use.
All return shipping charges are the responsibility of the customer.
- Repair after warranty expiration:
Upon request, we will repair the instrument at the customer’s expense, if the instrument’s performance is found to be recoverable by providing the repair.
- Replacement parts are available for a minimum period of five (5) years after termination of production. This storage period of replacement parts is considered as the period during which we can provide repair service. For further information, please contact your local distributor, or contacts on the last page.

When making an inquiry, please provide the following information.

- (1) PRODUCT name: Capture Hood
- (2) Model Number: 6710 or XXXX
- (3) Serial number: xxxxxx
- (4) P/O or Invoice No: xxxxxx
- (5) Description of the problem in detail:
- (6) Data of Purchase: Day, Month and Year



KANOMAX
The Ultimate Measurements

Kanomax Group Companies

Americas, Europe, Mid-East, Africa, Oceania

KANOMAX USA, INC.

219 US Highway. 206, Andover, New Jersey 07821

Tel: 1-800-247-8887(USA) / 1-973-786-6386

FAX: 1-973-786-7586

URL : www.kanomax-usa.com

E-Mail: info@kanomax-usa.com

Se Habla Espanol

Japan & Asia

KANOMAX JAPAN, INC.

2-1 Shimizu Suita City, Osaka Japan 565-0805

Tel: 81-6-6877-0183

FAX: 81-6-6879-2080

URL : www.kanomax.co.jp

E-Mail: sales@kanomax.co.jp

China

Shenyang Kano Scientific Instrument Co., Ltd

#2610, 51 Wulihe Street Heping District, Shenyang City, PRC

Tel: 86-24-23845309

FAX: 86-24-23898417

URL : <http://www.kanomax.com.cn/>

E-Mail: sales@kanomax.com.cn