

Compact Size Vibration Meter
MODEL 4200
Instruction Manual

KANOMAX JAPAN INC.

Composition of this Instruction Manual

This Instruction Manual explains the function and the operation method, etc. of Compact size Vibration Meter MODEL4200. Be sure to read the handling description of the apparatus concerned, when constructing with other apparatus and measuring.

Moreover, be sure to read notes about the safety indicated after the following page.

This Instruction Manual consists of each following chapter.

Overview

It describes for the outline of a main body.

Names and functions of various parts

It describes for the name and function of a switch or a terminal in each panel briefly.

Screen

It describes for the LCD in a front panel.

Preparation

It describes for battery installation, connection of a code, and attachment of a pickup are explained.

Setting

It describes for the time and sensitivity of setup.

Measurement

It fundamental describes for measurement.

Reference

It describes for the Velocity(VEL) frequency range and JIS, relation between indicated value and AC output.

Option

It describes for connection method with AC adapter of an option, a printer, and a personal computer..

Specification

It describes for the specification of a main body.

*Generally the company name and brand name in this instruction manual are the trademark or registered trademark of each company.

Safety precautions

To prevent bodily injury or damage to property, the following safety precautions must be observed.

This manual contains important safety and operating instructions for Compact Size Vibration Meter MODEL 4200.

Read all instructions, before using the instrument.

After reading all instructions, keep this manual for quick reference

1. Expressions of safety instructions



WARNING

Calls attention to a procedure, practice, or condition that could possibly cause death or bodily injury.



CAUTION

Calls attention to a procedure, practice, or condition that could possibly cause bodily injury or damage to instrument.

2. Important safety instructions

WARNING

- Stop using the instrument, when producing smoke, bad smell or noise. It causes fire or shock hazard. Turn off the POWER switch and unplug the AC adapter (optional) from outlet as soon as possible. To reduce risk of injury, take it to a qualified serviceman when service or repair is required. Please contact us or the dealer when service or repair is required.
- Do not substitute parts or modify instrument. It causes bodily injury, fire or shock hazard.
- Do not use the AC power adapter except the optional AC-1046.
Other type of adapter may cause damage to the instrument.
- Do not touch the plug of AC adapter (AC-1046) with wet hands. It causes shock hazard. Stop using the instrument, when an object or liquid falls/spills into the instrument. It causes fire or shock hazard. Turn off the POWER switch and unplug AC adapter (optional) from outlet as soon as possible.
To reduce risk of injury, take it to a qualified serviceman when service or repair is required.
Please contact us or the dealer when service or repair is required.

3. Cautions for usage

To prevent bodily injury or damage to the instrument, the following cautions must be observed.

CAUTION

- Keep the instrument away from the children. If the instrument falls down, it is very dangerous.
- Do not place it on an unstable place (shaky table or sloping place). If the instrument falls down, it is very dangerous.
- Do not use and storage the place which moisture or dust, and where a bad influence place which salt, sulfur, chemicals, Gas etc.. It causes fire or shock hazard.
- Do not put heavy objects on the instrument. It causes damage to the instrument.
- Connect cable properly, it is instructed in this manual. Wrong connection causes fire hazard.
- Connect cable properly, it is instructed in this manual. Wrong connection causes fire hazard.
- Before you move the instrument to other place, turn off the POWER switch and remove all wiring.
- Do not put the instrument on the vibrating place. If the instrument falls down, it is very dangerous.
- For avoiding liquid spill, remove alkaline dry batteries when you don't use for long period of time. It is recommended to remove alkaline dry batteries after each use.
- Please be sure undergo periodic inspection main body and pickup 1 or 2 times in an year. (Second calibration Sensitivity is Charge)
- Please don't push a liquid crystal display screen with a finger or a pen. It become the cause of defective display or malfunction.
- The connection connector of a main body and a curl cable is an one-touch type BNC connector. Please don't turn a part of connector at time connection or after connection. It become the cause of failure or malfunction.
- A magnet is very powerful (adsorptive power 100N). Be fully careful not injured, when detaching and attaching to a measurement subject. Moreover, what is influenced of magnetic should release a magnetic card etc. enough. It may destroy and break down.
- If it break down, please contact us to a store or an agency, without adding a hand.

Contents

SAFETY PRECAUTIONS	2
1. Expressions of safety instructions.....	2
2. Important safety instructions.....	3
3. Cautions for usage.....	3
CONTENTS	4
OVERVIEW	5
Features.....	5
NAMES AND FUNCTIONS OF VARIOUS PARTS	6~13
Front.....	6
Base.....	8
Background.....	9
Accelerometer.....	10
Description of Screen.....	11
Standard screen.....	11
Menu screen.....	13
PREPARATION	14~17
Power.....	14
Connection of a connection code.....	16
Attachment of an acceleration pickup.....	17
SETTING	20~21
Setting mode.....	20
Calendar adjustment.....	20
LCD contrast adjustment.....	21
MEASUREMENT	22~28
Power ON.....	22
Measurement of acceleration (ACC).....	23
Measurement the velocity (VEL).....	23
Measurement the Displacement (DISP).....	24
Data Recording.....	25
Data call.....	26
Data deletion.....	27
Output signal.....	28
REFERENCE 1	29
HANDLING OF AN OPTION ARTICLE	30~37
AC adaptor AC-1046.....	30
Connection with a printer.....	31
Set up of RS-232C.....	31
Connection with a PC.....	34
Detail Specification of Communication Command.....	35
Data managed software.....	37
SPECIFICATION	38
Accelerometer MODEL 7812B specification.....	38
Specification.....	38
REFERENCE 2	39~40
Relation between indicated value and AC output.....	39
A trouble and the processing method.....	40
How to connect/disconnect the cable	41~42

Overview

Vibration Meter “MODEL4200” is super mini-size like a cellular phone.

It offers, just like a “machinery doctor”, high precision monitoring of various industrial machinery by using the optional headphone or auscultation stick

It offers a simple way of making medical chart for your machine

The “data hold” function has highly promoted the easy observation of the numerical data

In addition, maintenance or examination of the existing machine, or experiment for a new facility under development, has been greatly promoted by fixing and numbering the measuring points on a large-scale target machinery, or by improving the mobility of the measurement based on the “single point” scheme stated above

Features

- Vibration can be actually heard with your own ear, aiming at the pinpoint spot in question
This is the time of the maintenance of facilities, by watching, hearing and measuring the vibration
- Compact design, light weight i.e., approx.130 g (Including batteries), that demonstrates power on the site of the measurement
- Single hand operation is possible just like a cellular phone
- Built in Memory for max.256 data.
- Built-in serial interface, enabling rapid data processing on your PC
- Restart the measurement with the last condition set up and stored just before the power-off
- The output to an exclusive printer is possible.
- Energy-saving design allows continuous measurement longer the 12 hours straight with only 4 dry battery cells, LR03.

Guarantee

Term for guarantee is twelve months after delivery.

Within this term repair is provided for free should a fault occur while the apparatus is being used in the manner prescribed by the manufacturer.

Otherwise, a repair fee will be charged.

Names and functions of various parts

Front

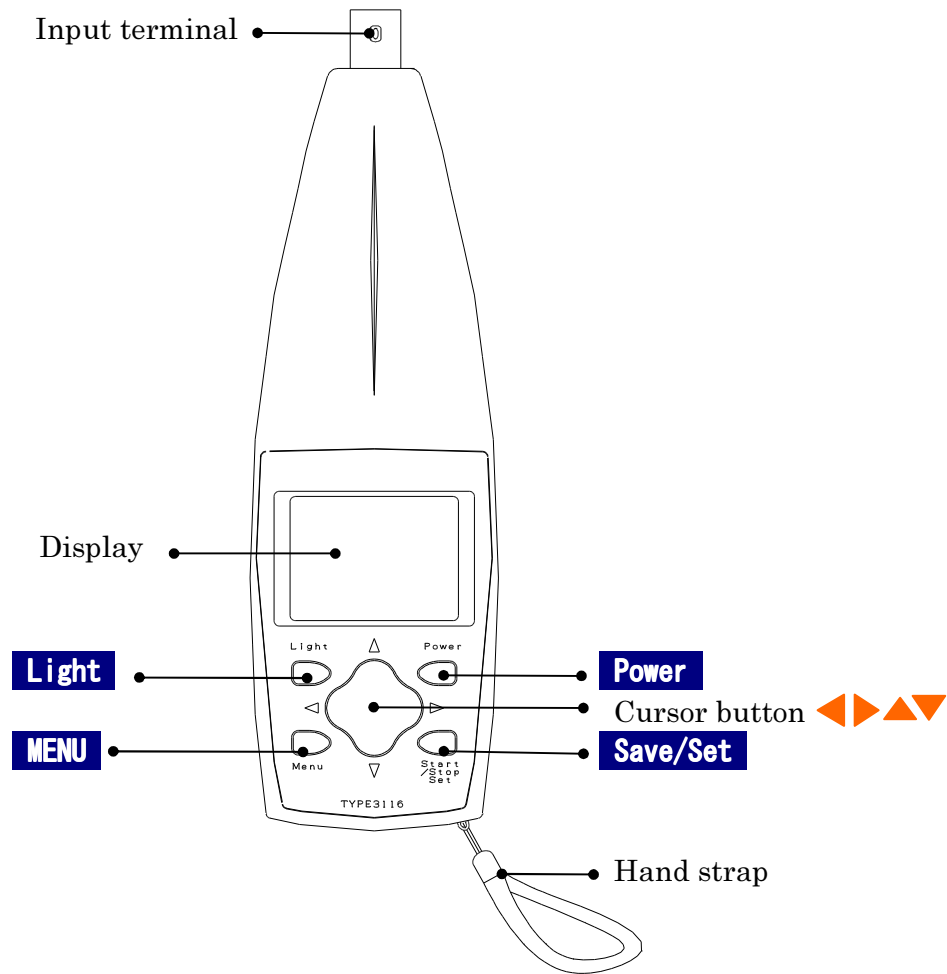

Input terminal

It is the terminal which connects pickup MODEL 7812B in attached connection code.

Display

The setting status of measured value and various switches are displayed.

Power

Long-pressing this switch for 1 sec or more turns on the power.

Long-pressing it again turns off the power.

Save/Set

Record at the time measurement, this is the setting button used when the Menu screen is operated.

Menu

It pushes, when setting up measurement conditions. Calendar adjustment etc. There are three Menu screens to 1/3-3/3. If it pushes 4 times, it will return to a standard screen.

******** is a setting value at the time of factory shipments.

Menu 1/3	Meas	: Manu	; Measurement
		Mem Clr	; Memory data clearance
		Mem Call	; Memory data call
	I/O	: OFF	; The data output OFF to external apparatus
		Printer	; Output to a printer
		PC	; Output to a PC
	Date	: 2000/01/01	; year/month/day
Time	: 00 : 00 : 00	; hour : minute : second	
Menu 2/3	Range	: 200, 20	(In the case of displacement 2000, 200)
	Mode	: m/s²	(Acceleration), mm/s (Velocity), μ m (Displacement)
	Filter	: OFF	(Acceleration), 1kHz (Velocity), 300Hz (Displacement) ※Mode and linkage (An single setup is impossible)
	Conv	: RMS, EQPP (EQp-p Only displacement) EQPK (EQPeak), PEAK	
	Disp Time	: 1s	; Indication period(Data display) display it every 1second 2s ; Indication period(Data display) display it every 2seconds
Menu 3/3	Moni/Level	: AC	; Waveform output
		Level ADJ	; Portable headphone output -3, -2, -1, 0, +1, +2, +3
	AutoPwrOff	: OFF	; Continuation operation
		ON	; Automatic power is turned off after about 1 minute.
	LCD cont	: *	; LCD contrast adjustment * . . . light * * * * * . . . deep
Baud rate	: 4800, 9600 , 19200	baud rate setup	

Light

Lighting and putting out lights of a LCD back light.

Whenever it pushes, lighting and putting out lights are repeated.

Even if the light stays on, it automatically goes out in approx. 30 seconds

Cursor button 

This is buttons for cursor operation, such as Mode/range, such as measurement conditions and change.

<Change of the Measurement mode>

It changes ; **m/s² (ACC)** → **mm/s (VEL)** → **μ m (DISP)** → **m/s² (ACC)** → **mm/s (VEL)**

<Change of the Measurement Range>

Number on the right of a bar it changes; 200 → 20 → 200.

(In the case of displacement 2000 → 200)

<Change of the Display mode>

It changes ; RMS → Peak → EQPeak → (In the case of displacement, EQp-p →)

Hand strap

When you have the main part of model4200 in hand, please let a hand pass to a hand strap for fall prevention.

Base

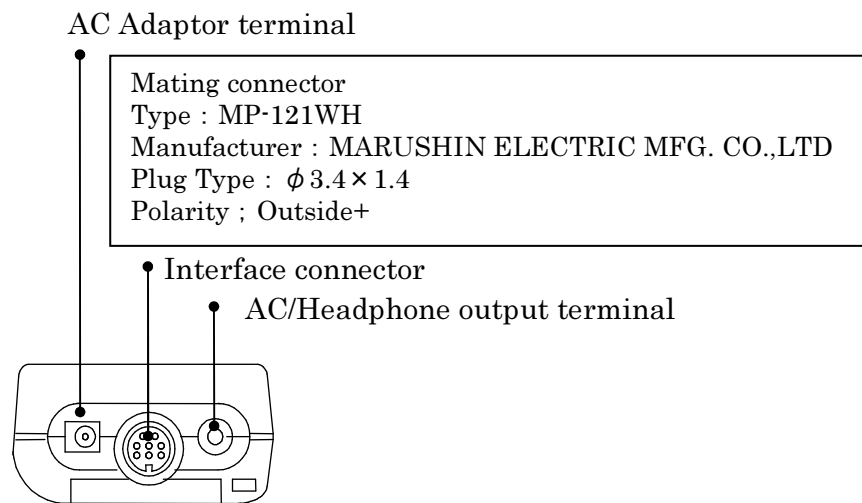
**AC Adapter Terminal (External Power Source Contact Terminal; EXT/DC)**

Connect to AC Adapter AC-1046(Optional)

**CAUTION**

- AC adapter of an option Please do not use it except AC-1046. If AC adapter besides specification is used, it will become the cause of failure, incorrect operation, an electric shock, and a fire.
- AC adapter AC-1046 should not take out and insert a power supply plug by the wet hand. It becomes the cause of an electric shock.

Interface Connector (I/O)

Connect to Printer(BS-80TSL) or Personal Computer with Interface cable(with Converter Adapter)BC-0026

AC/Portable Headphone Output Terminal

A waveform signal is outputted when Menu 3/3 Moni / Level is "AC". Moreover, you can act as the monitor of the vibration value which plug adapter PC-260MS connect with portable headphone ATH-FC5 BK of an option at the time of a level ADJ "-3 and -2...+3".

Background

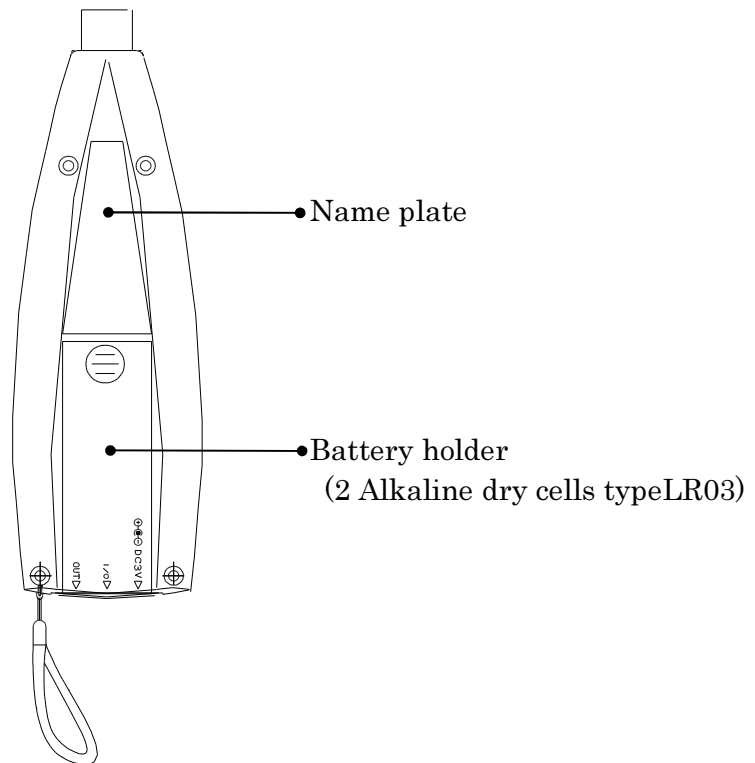

Name plate

You can see a name, Type, Serial No. and Date of Manufacture etc..

Battery holder

2 Alkaline dry cells type LR03.

Accelerometer

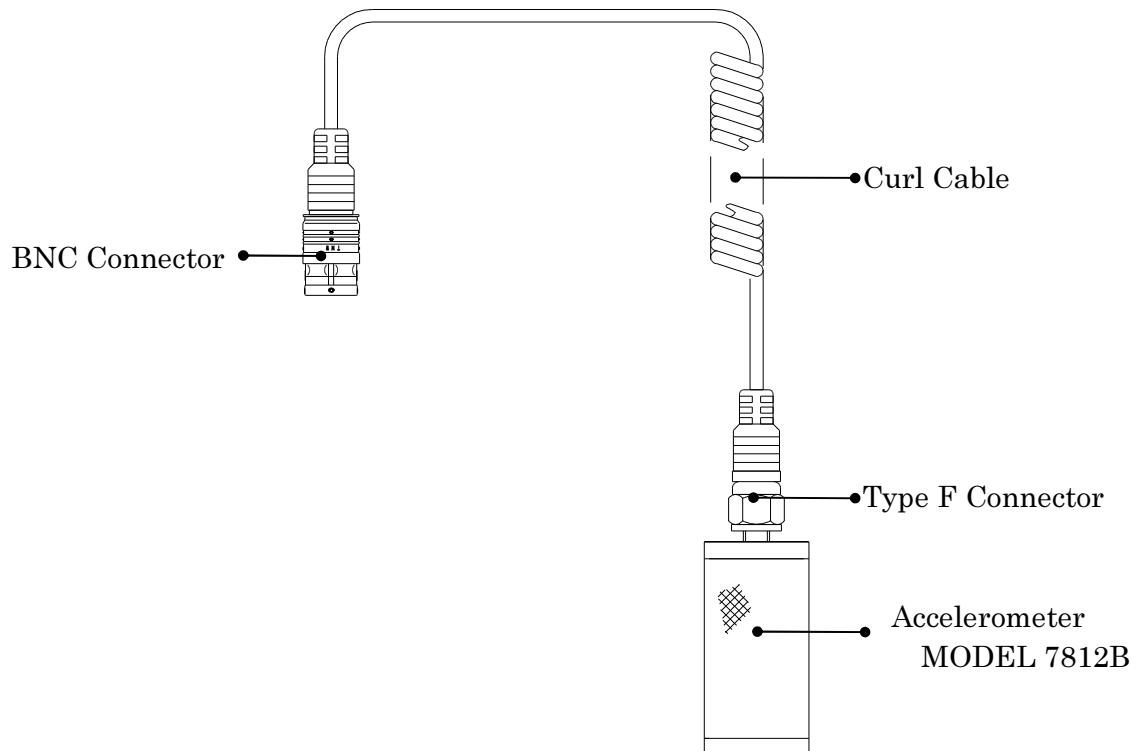

BNC Connector

Connect to Input Terminal of Main Body MODEL4200



CAUTION

- The connection connector of a main body and a curl cable is an one-touch type BNC connector. Please do not turn by the connector part the time of connection, or after connection. It becomes the cause of failure or incorrect operation.

Type F connector

Connect to Output Terminal of MODEL 7812B

Accelerometer MODEL 7812B

Detect vibration and change it into an electric signal and fix it with screw stoppers in un-measurement.

(Reference to P. 18 ~P. 19 How to fix)

Description of Screen

Standard screen

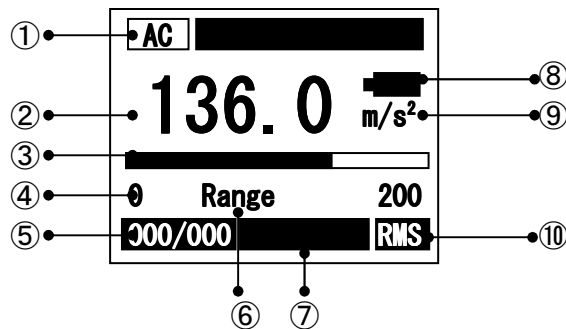

① Output Mode

Display the Output mode of Headphone output terminal on the base.

AC : Waveform output

Level ADJ : Headphone output -3, -2, -1, 0, +1, +2, +3

A waveform signal is outputted when Menu 3/3 Moni / Level is "AC". Moreover, you can act as the monitor of the vibration value which plug adapter PC-260MS connect with portable headphone ATH-FC5 BK of an option at the time of a level ADJ "-3 and -2····+3".

② Data display

Displays the present value by digital value in intervals of approx.1second or 2seconds. Select with Menu 3/2 Disp Time.

③ Bar display

Displays the present momentary value with a bar.

The bar displays the value of the displayed data in intervals of approx. 0.1 seconds.

④ Range display

Displays the range set with the **Range** key. 0 — 20, 0 —200 (Displacement Mode ; 0 — 200, 0 —2000).

⑤ The number of the record data display

Displays the number of the record data 001~256.

⑥ Selected Mode display of cursor button

Displays the variable mode by cursor button

Range : Change Level Range

0 — 20, 0 —200 (Displacement Mode ; 0 — 200, 0 —2000)

Peak/RMS : Change Display Mode

RMS ; True Effective value

Peak ; waveform amplitude value

EQPeak ; $\text{RMS} \times \sqrt{2}$

EQp-p ; $\text{RMS} \times \sqrt{2} \times 2$ (only Displacement)

Mode : Changes Measurement Mode

m/s² ; Acceleration (ACC)

mm/s ; Velocity (VEL)

μm ; Displacement (DISP)

⑦ Display of state

no display	: Normal display
Ov	: Blinking Over display
Hold	: Blinking Data save
Memory	: Blinking Memory display mode
Save	: Blinking Turn off after selected cursor button

⑧ Display the condition of the batteries

Display the condition of the batteries. Reference to Battery installation P14 ~ 15.

⑨ Display Measurement Mode

Measurement Mode

m/s ²	: Acceleration (ACC)
mm/s	: Velocity (VEL)
μ m	: Displacement (DISP)

⑩ Change Display Mode

Peak/RMS	: Change Display Mode
RMS	; True Effective value
Peak	; waveform amplitude value
EQPeak	; $\text{RMS} \times \sqrt{2}$
EQp-p	; $\text{RMS} \times \sqrt{2} \times 2$ (only Displacement)

Menu screen

It pushes, when setting up measurement conditions. There are three Menu screens.

If it pushes 4 times, it will return to a standard screen.

******** is a setting value at the time of factory shipments.

Menu 1/3

<Menu>	1/3
Meas	:Manu
I/O	:OFF
Date	:00/00/00
Time	:00:00:00

Meas	: Manu	; Measurement
	Mem Clr	; Memory data clearance
	Mem Call	; Memory data call
I/O	: OFF	; Output OFF of the data is carried out to an outer instrument.
	Printer	; Output to a printer
	PC	; It data-outputs to a PC
Date	: 2000/01/01	; year/month/day
Time	: 00:00:00	; hour : minute : second

Menu 2/3

<Menu>	2/3
Range	:20
Mode	:m/s ²
Filter	:OFF
Conv	:EQPK
Disp Time	:1s

Range	: 200, 20 (In the case of displacement 2000 , 200)
Mode	: m/s² (Acceleration) , mm/s (Velocity) , μm (Displacement) (A Filter also interlocks)
Filter	: OFF (Acceleration) , 1kHz (Velocity) , 300Hz (Displacement) (An independent setup is impossible)
Conv	: RMS , EQPP (EQp-p Only displacement) EQPK (EQPeak) , PEAK
Disp Time	: 1s ; Indication period(Data display) display it every 1second 2s ; Indication period(Data display) display it every 2seconds

Menu 3/3

<Menu>	3/3
Moni/Level	:AC
AutoPwrOff	:OFF
LCD cont	:*
Baud rate	:9600

Moni/Level	: AC	; Waveform output
	Level ADJ	; Portable headphone output -3, -2, -1, 0, +1, +2, +3
AutoPwrOff	: OFF	; Continuation operation
	ON	; Power is turned off after about 1 minute.
LCD cont	: *	; LCD contrast adjustment * . . . thin * * * * * . . . deep
Baud rate	: 4800, 9600 , 19200	baud rate setup

Preparation

The required matter is indicated before beginning measurement.

Please do at a position of power switch is off at the time of set the battery and connection cords.

Power

It operates by two alkaline dry cells type LR03 or AC adapter AC-1046 (option).

Battery installation

When the unit is in operation, turn off the power by pressing the **Power** switch.

- 1) Slide the battery cover of the back to the lower direction while pressing down on the cover.

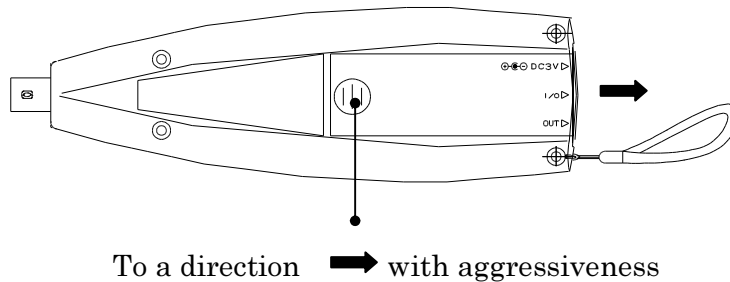

- 3) Insert two AAA dry cell batteries in the direction indicated in the battery case and close the battery cover.

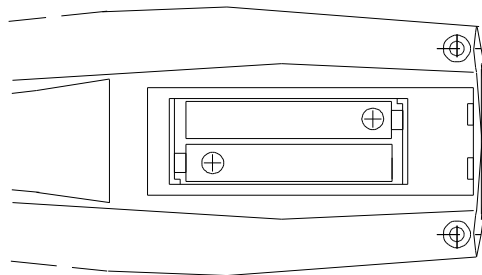

The battery life is changed by environment to be used.

It is possible to continuation use for about 12hours in case of two alkali dry cells AAA.



CAUTION

- Please be sure to remove a dry cell AAA, when there is no schedule used for a week or more.
It may become the cause of failure by liquid leak.
- Please put in correctly polar "+" and "-" of a dry cell not to mistake.
- Moreover, please put in the new dry cell of the kind with four [same] at the time of exchange. A different kind and use of old and new is cause failure.

3) Long-press the **Power** button for 1 sec or more.

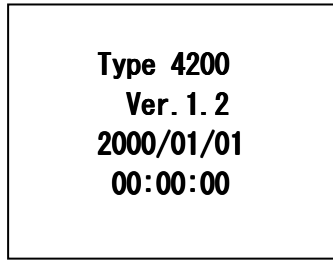
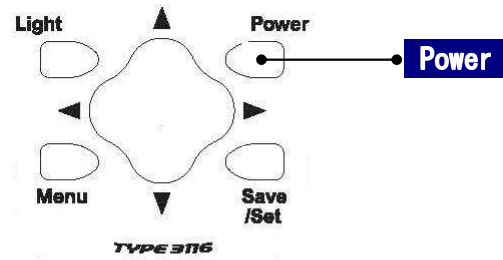

Start Screen

The indicator is shown battery remaining capacity on the upper right of a display screen.

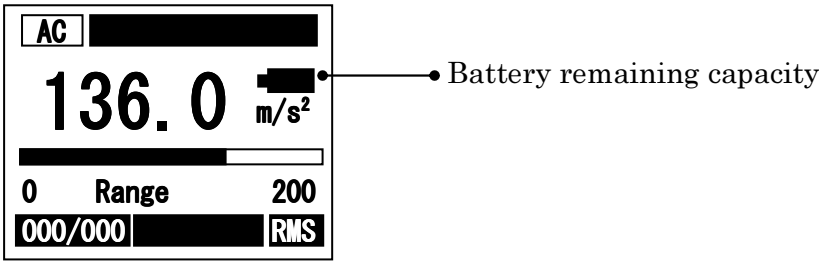

The following displays tell you the condition of the batteries.

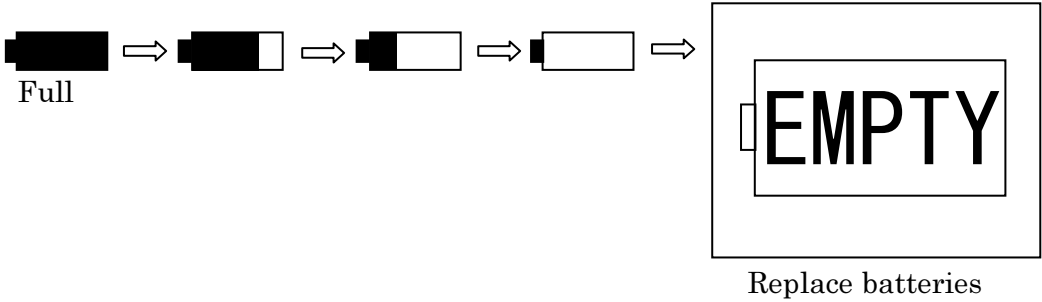

When LCD display tells low battery, install new batteries.
For long-term measurement, install new batteries in advance.

Connection of a connection code

- 1) When the unit is in operation, turn off the power by pressing the **Power** switch.

Acceleration pickup MODEL 7812B and Compact size vibration meter MODEL4200 are connected

by curl cable as shown in the following figure.

- 2) The BNC connector of a curl cable is connected to the input terminal of a main part. Mark (↔) of the BNC connector(a input terminal) projection portion by the side of a main body and the BNC connector of a curl cable is united, and it pushes in straightly. It draws out straightly at the time of removal.

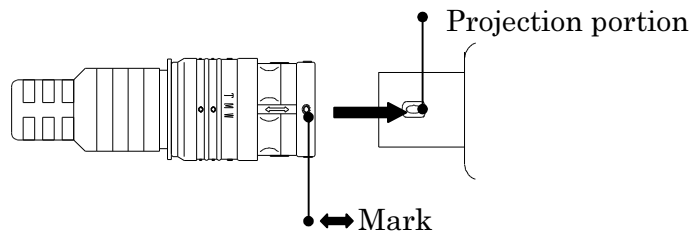

CAUTION

- The connection connector of a main part and a curl cable is one-touch type BNC connector. Please do not turn by the connector part at the time of connection, or after connection. It becomes the cause of failure or incorrect operation.

- 3) Accelerometer connect to Connector of F TYPE.

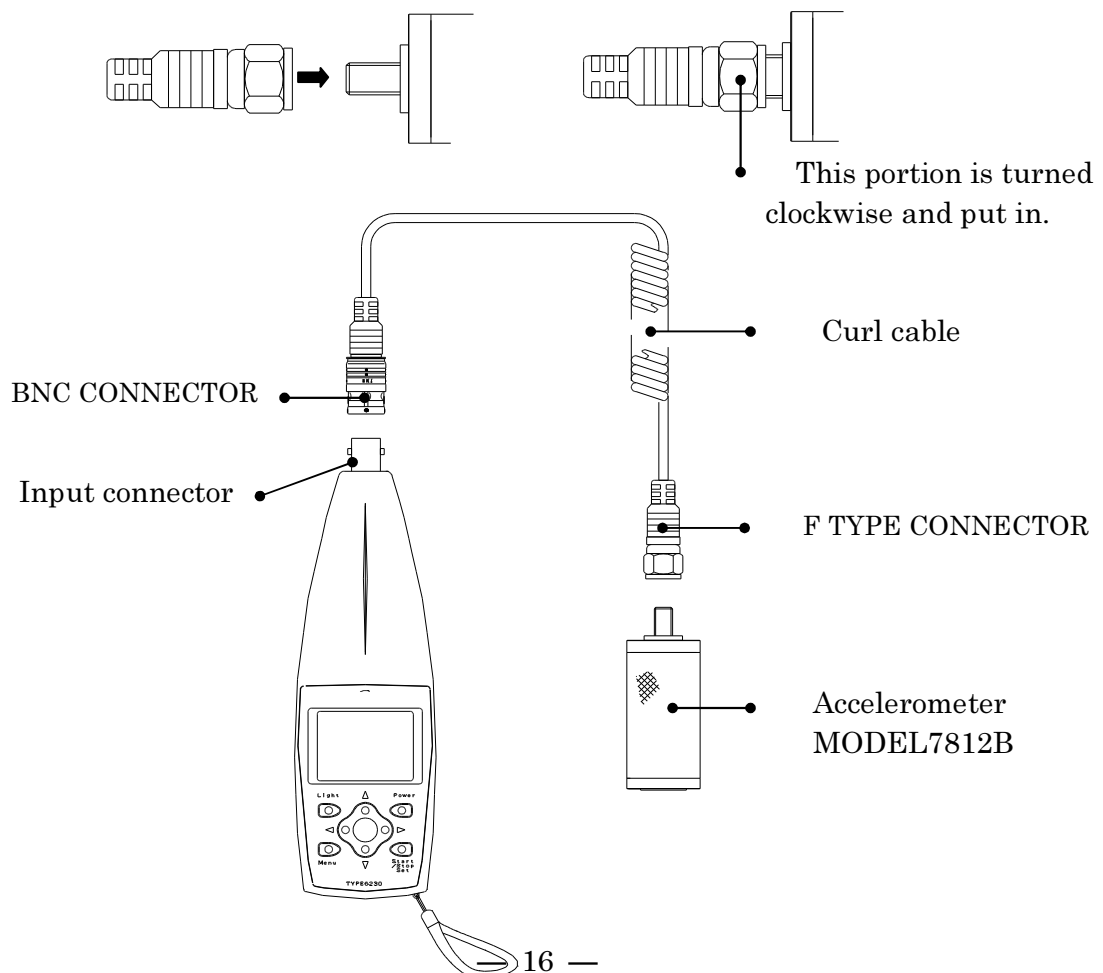

Attachment of an acceleration pickup

There are some methods of attachment to the measurement subject of Accelerometer. Contact resonance frequency * changes with the attachment methods of an Accelerometer sharply.

Please perform suitable attachment in consideration of the advantage and fault of each attachment method

*Contact resonant frequency and the high region characteristic

If an Accelerometer is attached in a measurement subject, one vibration system will be formed and the peculiar resonance frequency of the system will be decided.

This is called contact resonance frequency.

Contact resonant frequency is boiled variously and changes with the fixed method of Accelerometer and measurement subject, or contact states.

A lower figure shows change of the high region characteristic by the attachment method. Therefore, the suitable attachment method of Accelerometer is chosen, and in order to remove the influence of Contact resonant frequency further, it is necessary to choose the frequency range.

]:

An example of change that high frequency response by the Accelerometer attachment method is shown below.

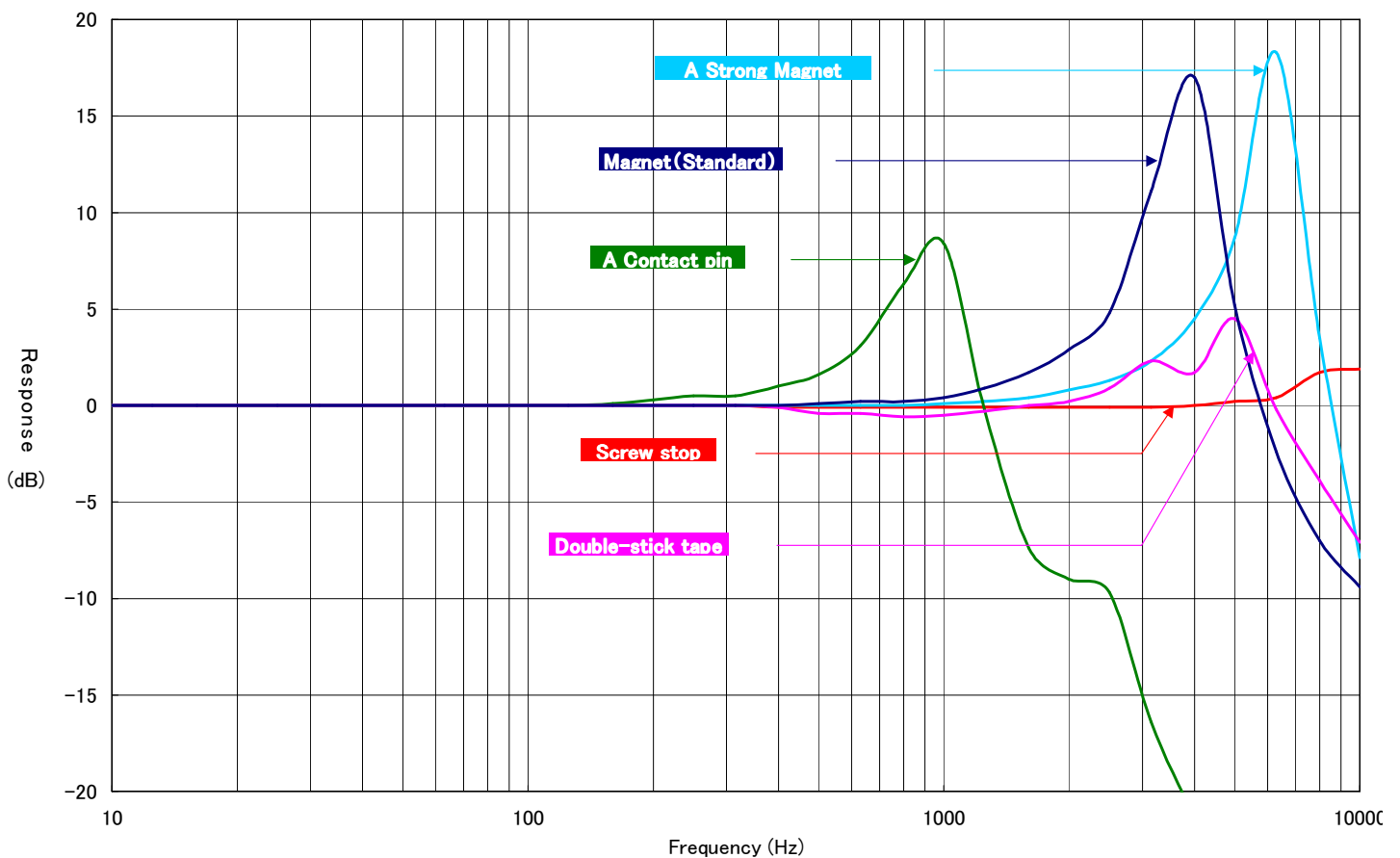

Fixation with a screw

The usage which fixes an acceleration pickup with a screw is the most fundamental method, and its oscillation characteristic is the best

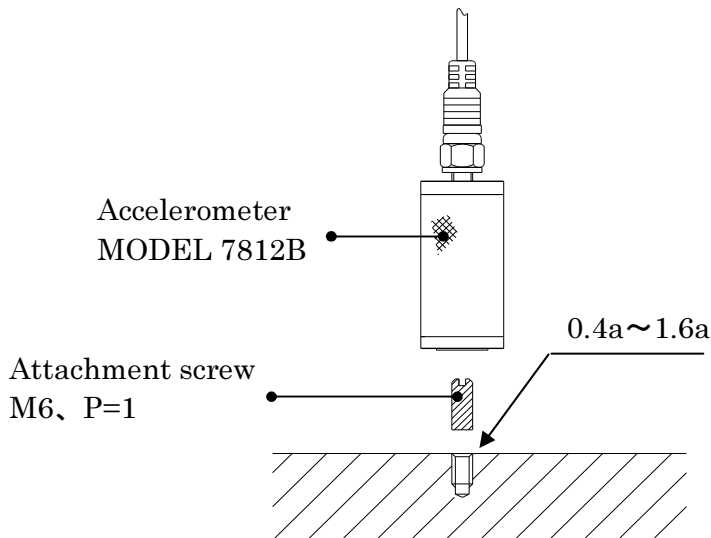

Please make 0.4a-1.6a to the surface of an attachment side.

Please fasten the bolting torque with an Accelerometer, an attachment screw, and a measurement subject by 1 - 1.5 N·m.

Accelerometer is a product made from an aluminum alloy. Please apply a thin of silicon grease to the screw parts and you can mount smoothly.

Fixation with a Magnet

Although a magnet can be used when the measurement subject is made of the metal which sticks to a magnet, since contact resonant frequency falls, it is restricted to measurement for middle and low frequency.

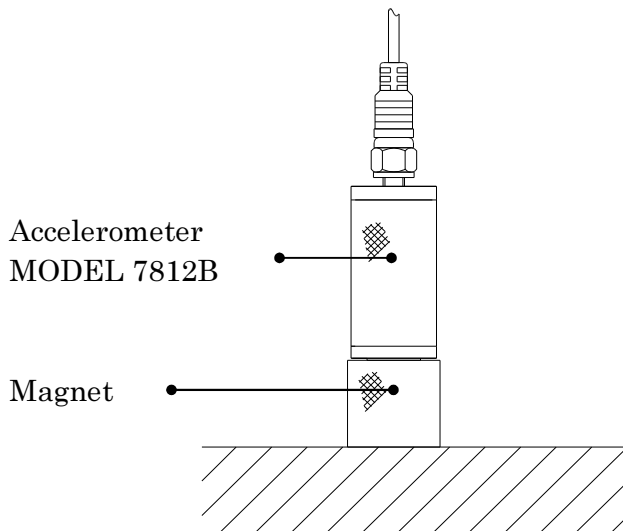

Please fasten the bolting torque of a Accelerometer and a magnet by 1 - 1.5 N·m.

Accelerometer is a product made from an aluminum alloy.

Please apply a thin of silicon grease to the screw parts and you can mount smoothly.



CUTION

- A magnet is very powerful (adsorption power 100N). Please be careful not to be hurt enough, when attaching and detaching to a measurement subject. Moreover, what is influenced of magnetic should release a magnetic card etc. enough. It may destroy and break down.

Forcing by the contact pin

Measure in the place of an unfixable narrow place or a thin pipe where does not have sufficient contact surface product using a contact pin.

Although it is the easiest method, 500 or more Vibration measurement cannot be performed because Contact Resonant Frequency falls very much,

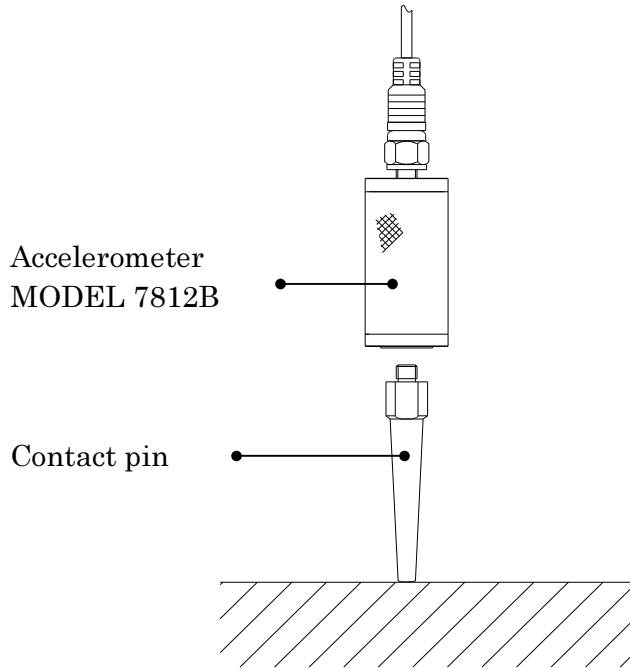

Please fasten the bolting torque of an Accelerometer and Contact pin by 1 - 1.5 N·m.

An Accelerometer is a product made from an aluminum alloy.

Please apply a thin of silicon grease to the screw parts and you can mount smoothly.

Fixation a double-sided tape

When Vibration frequency is low, and amplitude is small, it can fix with double-sided adhesive tape.

Setting

Setting mode

Whenever it pushes a **Menu** button, standard screen (measurement screen) → **MENU 1/3** → **MENU 2/3** → **MENU 3/3** → standard screen (measurement screen) it changes.

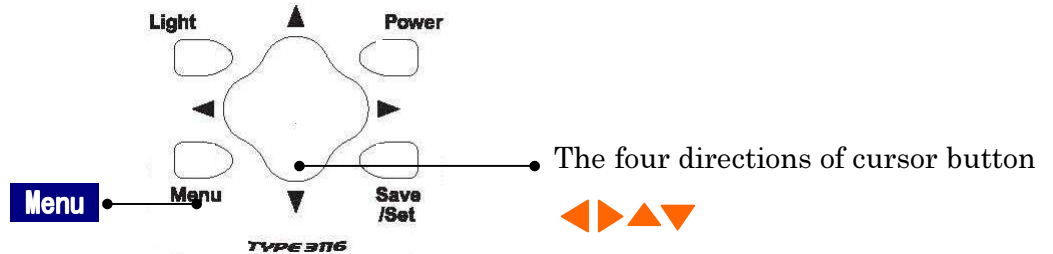

Calendar adjustment

To adjust the calendar (time), operate as follows.

You can adjust calendar in the [Menu] mode in the same way as LCD adjustment.

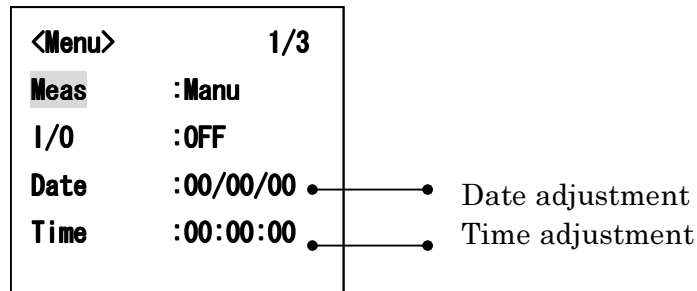

【Calendar adjustment】

- 1) When you press the **Menu** button the following screen **<Menu 1/3>** appears.
- 2) Select **Date** with **Cursor** button ▼, then move the cursor rightward with cursor button ▶.

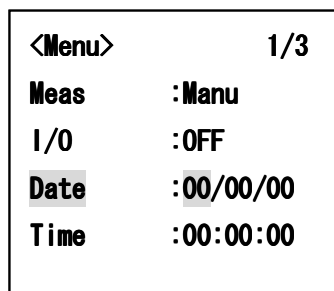

- 3) Set the year/month/day with ◀▶ cursor button and select numerical value with cursor button ▲▼, then press **Save/Set** button to save the setting.
After pressing **Save/Set** button, the cursor moves to leftward.
- 4) If you want to go back to the measurement mode, pressing it three times returns to the **Menu** button.

【Time adjustment】

- 1) When you press the **Menu** button the following screen appears.
- 2) Select **time** with **Cursor** button ▼ , then move the cursor rightward with cursor button ► .

<Menu>	1/3
Meas	:Manu
I/O	:OFF
Date	:00/00/00
Time	:00:00:00

- 3) Set the hour : minute : second with cursor button ◀▶ , then press **Save/Set** button to save the setting.
After pressing **Save/Set** button , the cursor moves leftward.
- 4) If you want to go back to the measurement mode, pressing it three times returns to the **Menu** button.

LCD contrast adjustment

You can adjust LCD contrast, when the batteries were low, or when the new batteries were installed. The procedure is as follows.

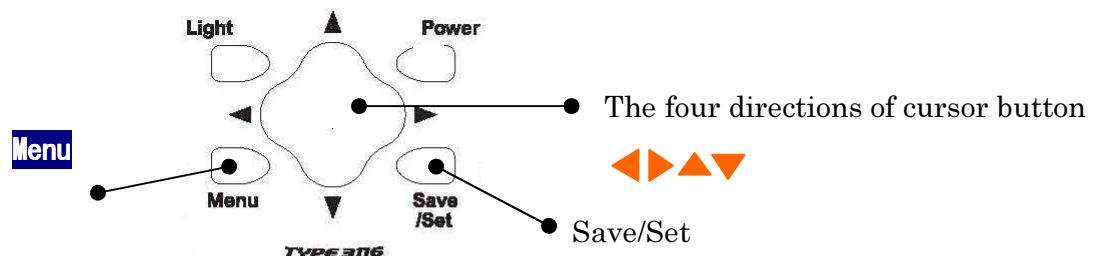

- 1) When you press the **Menu** button three to return to the following screen appears.
- 2) Select LCD cont with **Cursor** button ▼ , then move the cursor rightward with cursor button ►.

<Menu>	3/3
Moni/Level	:AC
AutoPwrOff	:OFF
LCD cont	:*
Baud rate	:9600

- 3) Adjust the LCD contrast with cursor button ▲▼ , then press **Save/Set** button to save the setting.
After pressing **Save/Set** button, the cursor moves to leftward.
- 4) Press the **Menu** button one to return to the measurement screen.

Measurement

Power ON

1) Long-press the **Power** button for 1 sec or more. Immediately after the power goes on, the following screen is displayed:

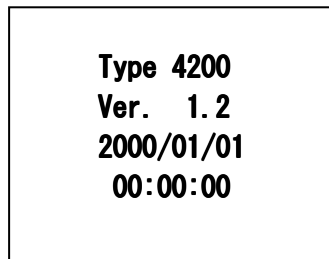
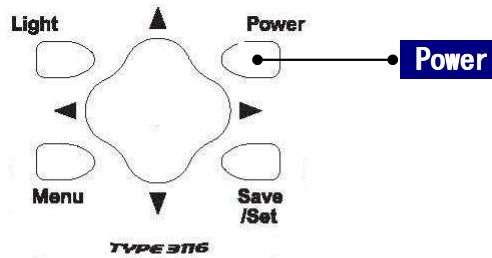

Start Screen

↓ After about 5 seconds

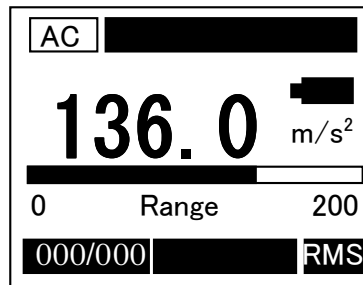

Measurement of acceleration (ACC)

Just after power supply on, it starts with the acceleration measurement mode mentioned above. The current value is displayed in digital form at an interval of 2 sec and a bar at an interval of 0.1 seconds.

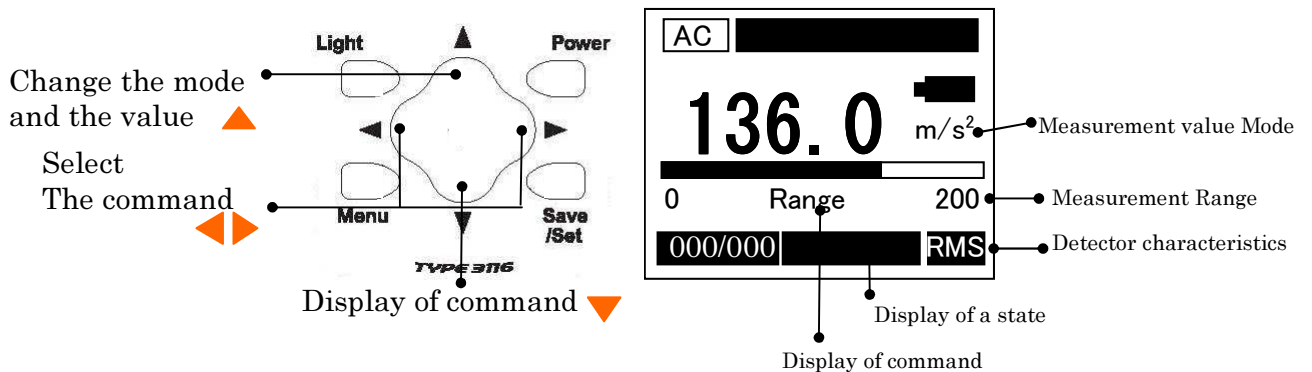

< Change of the Measurement mode >

1) Select the command with cursor button ◀▶, the Range change to Mode.

2) Mode is [m/s²] with cursor button ▲.

(It changes ; m/s² → mm/s → μm → m/s² → mm/s)

< Change of the Measurement Range >

1) Select the command with cursor button ◀▶ again, the Range change to Mode.

2) Operated so that a level may become a legible value with cursor button ▲.

(Number on the right of a bar It change with 200 → 20 → 200.)

Since [OV] (Overload) is displayed when a value is large, a range is adjusted.

< Change of the Detector >

1) When you want to change the mode and measure, (RMS/PEAK), display the "Peak/RMS" by the command selection cursor button ◀▶, and changes by the cursor button ▲.

Whenever it pushes, the mode changes with RMS → Peak → EQPeak → RMS.

2) It is pressing cursor button ▼ and display can be Hold(ed) to fix a display value.

A key is pressed again to acquire the value again.

Measurement the velocity (VEL)

The current value is displayed in digital form at an interval of 2 sec and a bar at an interval of 0.1 seconds.

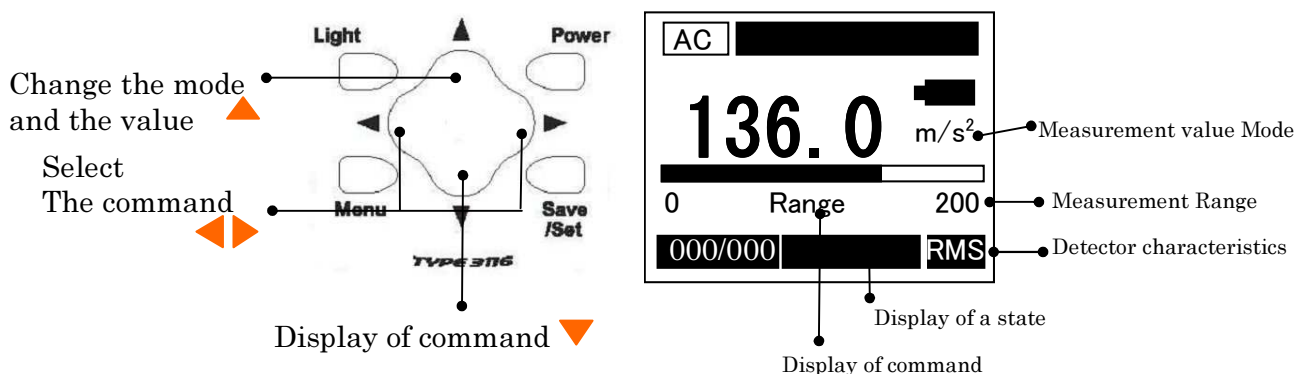

< Change the measurement mode >

- 1) Select the command with cursor button ◀▶ , the Range change to Mode.
- 2) Mode is **mm/s** with cursor button ▲ .
 ($m/s^2 \rightarrow mm/s \rightarrow \mu m \rightarrow m/s^2 \rightarrow mm/s$)

The operation method of a measurement range and display mode data recording is the same as acceleration (ACC).

Measurement the Displacement (DISP)

The current value is displayed in digital form at an interval of 2 sec and a bar at an interval of 0.1 seconds.

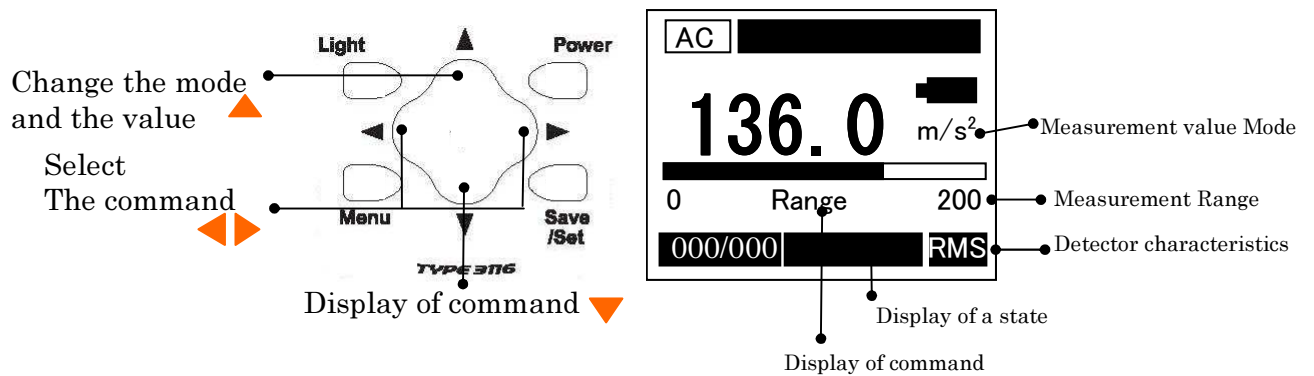

< Change the measurement mode >

- 1) Select the command with cursor button ◀▶ , the Range change to Mode.
- 2) Mode is **μm** with cursor button ▲ .
 ($m/s^2 \rightarrow mm/s \rightarrow \mu m \rightarrow m/s^2 \rightarrow mm/s$)

The operation method of a measurement range and display mode data recording is the same as acceleration (ACC).

Data Recording

It is inputting **Save/Set** and can record at any time to record data.

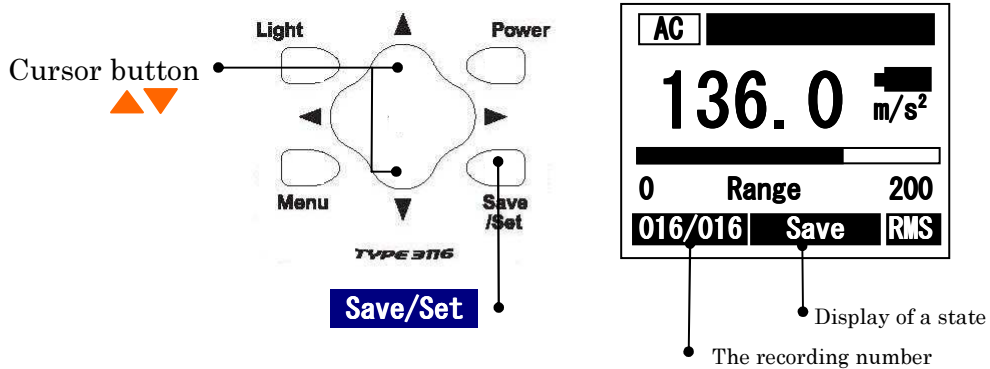

- 1) Push the **Save/Set** blinks **Save**.
- 2) Select the recording number with cursor button ▲▼ .



- 3) It will be recorded if **Save/Set** is pushed again (a Save display disappears).
If **Save/Set** is pushed continuously, it will be recorded on the newest number. Movement with cursor button ▲▼ is restricted to a number [finishing / record].

Data call

You can see the recorded data with Meas of Menu 1/3 is set to Mem Call.

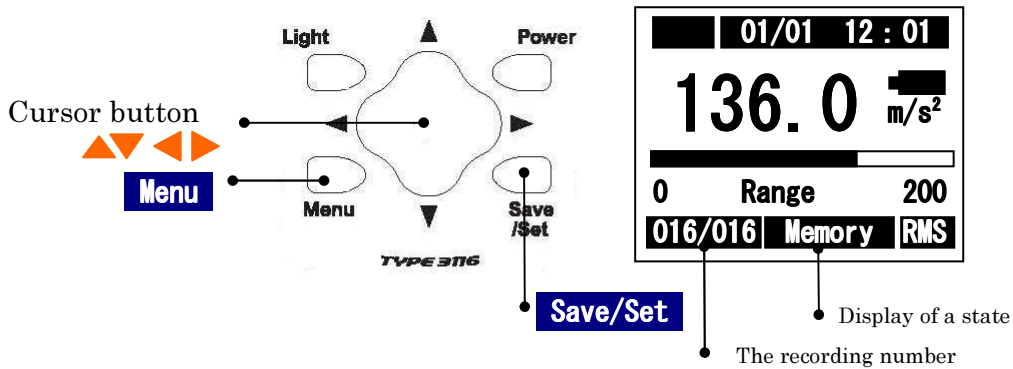

- 1) When you press the **Menu** button the following screen appears.
- 2) Select **Meas** with Cursor button ▼, then move the cursor rightward with cursor button ►.

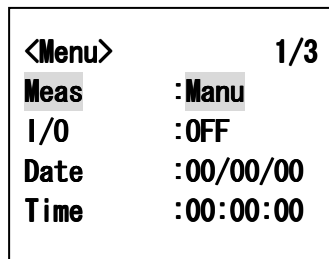

- 3) Set the **Mem Call** with cursor button ▲▼, then press **Save/Set** button to save the setting. After pressing **Save/Set** button, the cursor moves leftward.
- 4) If you want to go back to the measurement mode, pressing it three times returns to the **Menu** button.
- 5) If you select a Recording Number with cursor button ▲▼, a data display.



Data deletion

You can see the recorded data with Meas of Menu 1/3 is set to Mem Clr.

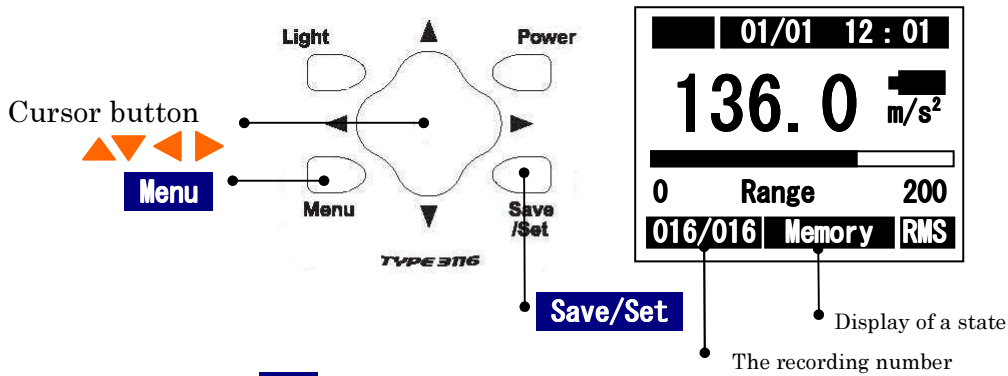

- 1) When you press the **Menu** button the following screen appears.
- 2) Select **Meas** with **Cursor button** ▼, then move the cursor rightward with cursor button ►.

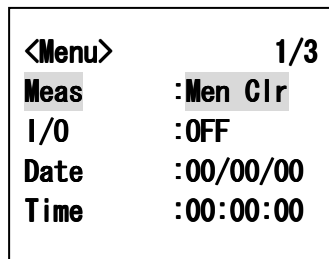

- 3) Set the **Mem Clr** with cursor button ▲▼, then press **Save/Set** button to save the setting.

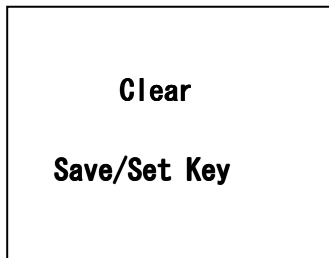

- 4) It delete the data with **Save/Set**.
- 5) If you want to go back to the measurement mode, pressing it three times returns to the **Menu** button.
- 6) The recording number / Total data becomes 000/000.▲▼



Output signal

Using AC / Portable headphone output terminal which is the bottom of a main part can observation and record output signal.

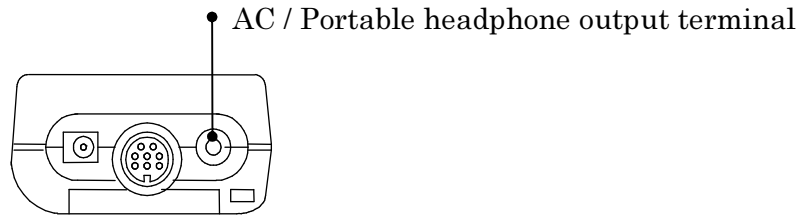

A waveform signal is output when Menu 3/3 Moni/Level is AC.

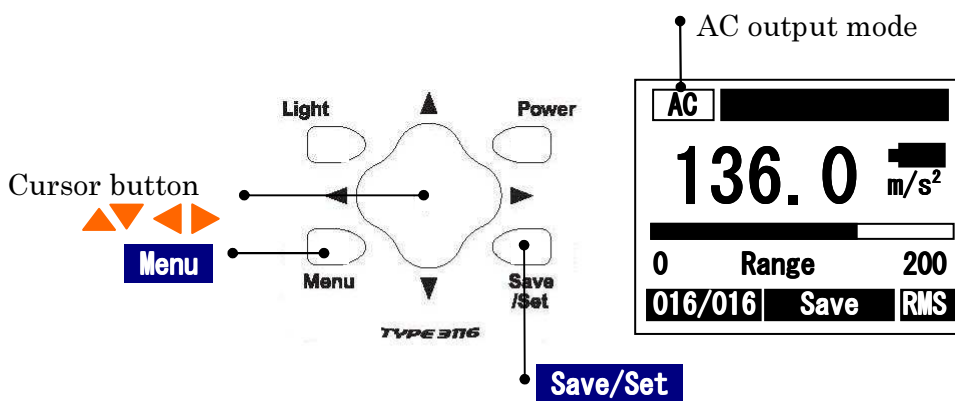

- 1) When you press the **Menu** button the following screen appears.
- 2) Select **Moni/Level** with Cursor button \blacktriangledown , then move the cursor rightward with cursor button \blacktriangleright .

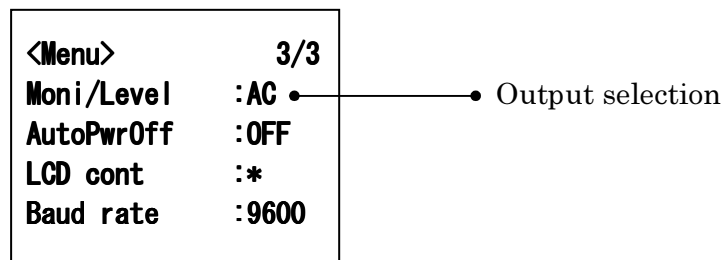

- 3) Set the **AC** with cursor button $\blacktriangle\blacktriangledown$, then press **Save/Set** button to save the setting. After pressing **Save/Set** button, the cursor moves leftward.
- 4) If you want to go back to the measurement mode, pressing it a time returns to the **Menu** button.

Reference 1

Velocity (VEL) Frequency characteristics JIS Standards

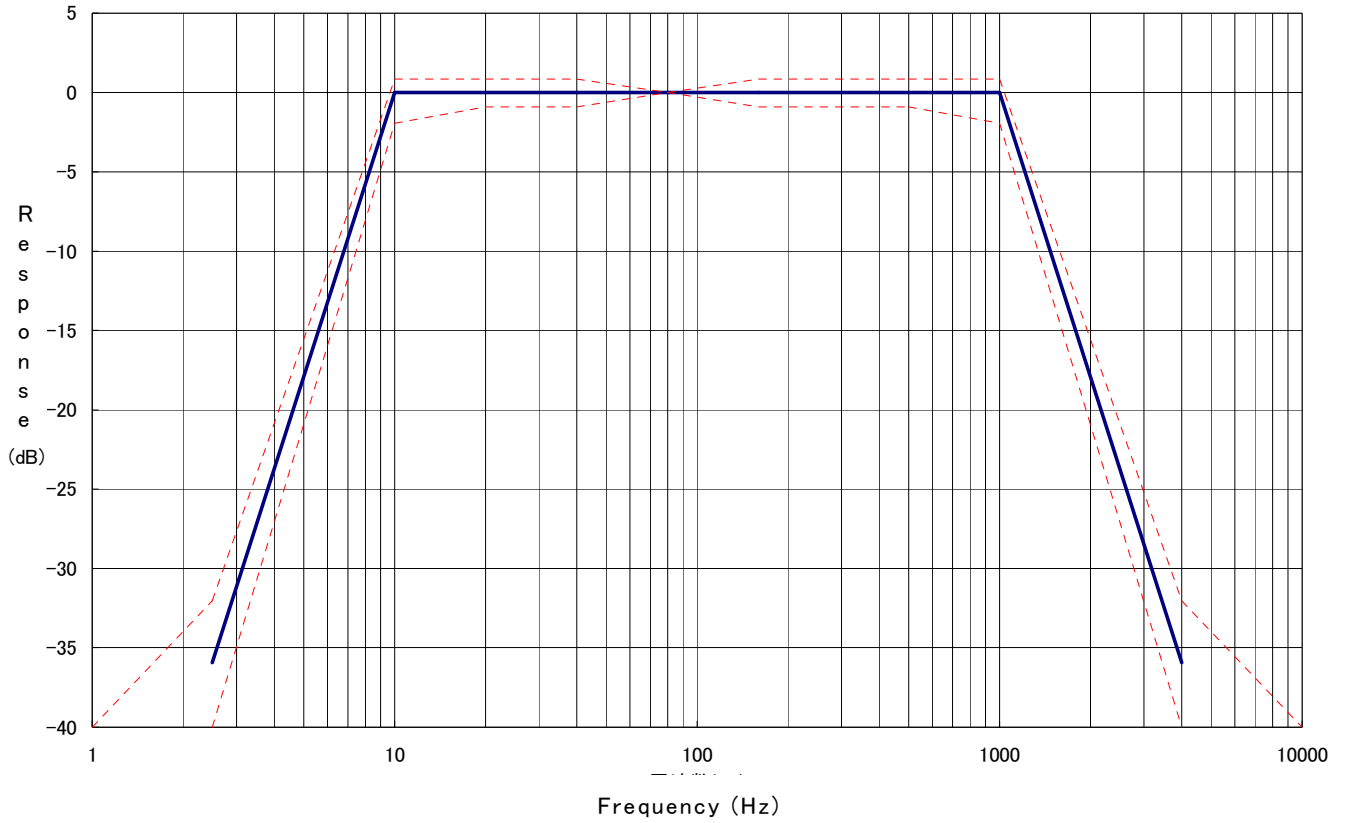

*This inside of a dotted line with a velocity of 10-1kHz satisfies the frequency range about mechanical vibration of rotating for vibration severity of JIS B0907~1989.

Handling of an option article

AC adaptor AC-1046

When you use a main body by AC adaptor AC-1046 (option), please connect, as shown in the following figure.

Please connect it you should check that the power supply of a main part is turned off.

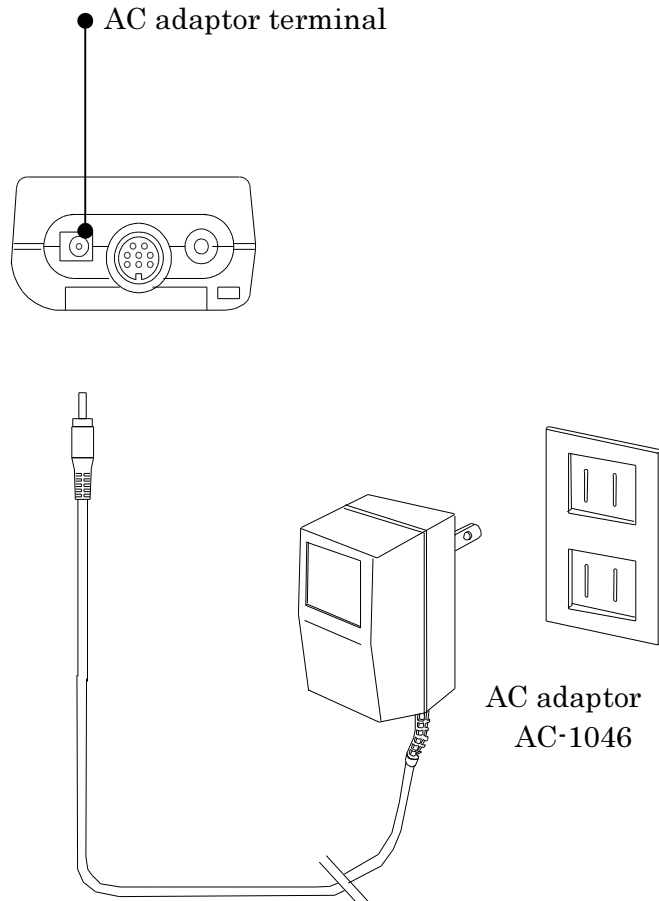

CAUTION

- Stop using the instrument, when producing smoke, bad smell or noise. It causes fire or shock hazard. Turn off the POWER switch and unplug the AC adaptor (optional) from outlet as soon as possible. To reduce risk of injury, take it to a qualified serviceman when service or repair is required. Please contact us or the dealer when service or repair is required.
- Do not substitute parts or modify instrument. It causes bodily injury, fire or shock hazard.
- Do not use the AC power adapter except the optional AC-1046.
Other type of adapter may cause damage to the instrument.
- Do not touch the plug of AC adapter (AC-1046) with wet hands. It causes shock hazard. Stop using the instrument, when an object or liquid falls/spills into the instrument. It causes fire or shock hazard. Turn off the POWER switch and unplug AC adapter (optional) from outlet as soon as possible. To reduce risk of injury, take it to a qualified serviceman when service or repair is required. Please contact us or the dealer when service or repair is required.

Connection with a printer

Connect a main body and printer BS-80TSL with the interface cable BC-0026 as shown in the following figure.

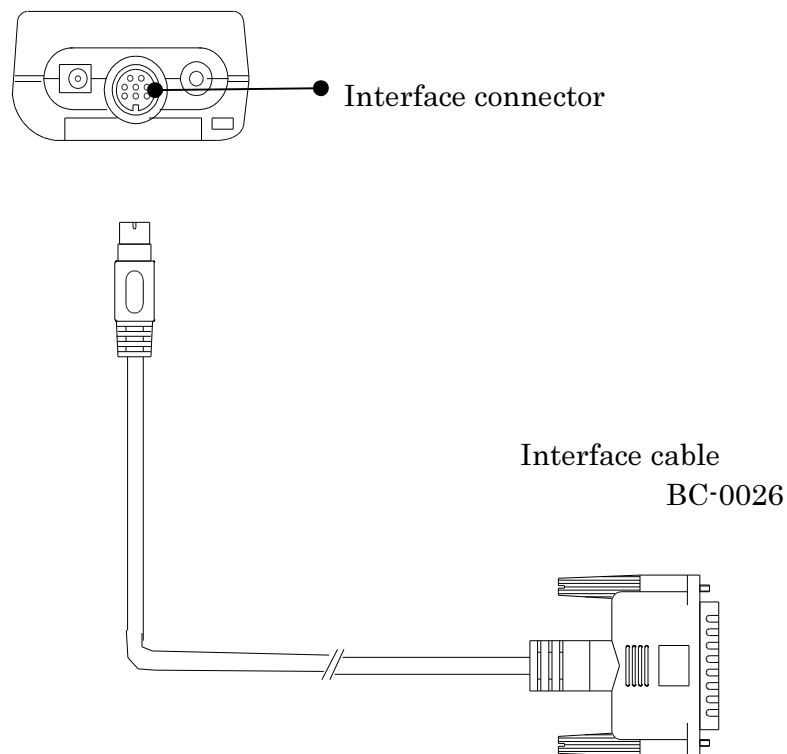

Set up of RS-232C

Set up the RS-232C by Menu 3/3 baud rate of a main body.

- 1) It is made a screen. **<Menu 3/3>** with push 3 times **Menu**.

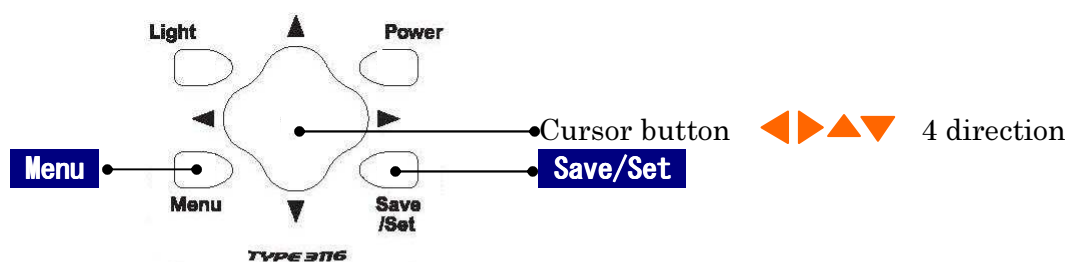

- 2) Select **baud rate** with Cursor button **▼**, then move the cursor rightward with cursor button **▶**.

<Menu>	3/3
Moni/Level	:AC
AutoPwrOff	:OFF
LCD cont	:*
baud rate	:9600

- 3) Set the 9600 with cursor button **▲▼**, then press **Save/Set** button to save the setting.

The printing method

Refer to the handling description of a printer for the printer operation method.

- 1) The power supply of a printer is turned ON.
- 2) A setup of a printer is set up as follows.

(Please refer to the handling description P.12 of a printer for details.)

- ◇A setup of an international character = Japan
- ◇A setup of printing concentration = 100(%)
- ◇A setup of head operation = - > Both sides < -
- ◇The number of printing beams of one line = Graphic(28)
- ◇A setup of half size / full-size character = Full(28)
- ◇Auto line feed setup = Invalidity(OFF)
- ◇SELECT switch use = Available(ON)
- ◇RS232C Baud rate setup = 9600bps
- ◇RS232C Data bit length setup = 8bit
- ◇RS232C Parity setup = Non
- ◇RS232C Control system = Xon/Xoff

- 3) SELECT Light Emitting Diode of a printer is made lighting.
4. **Menu** It pushes and is <Menu 1/3>. It is made a screen.

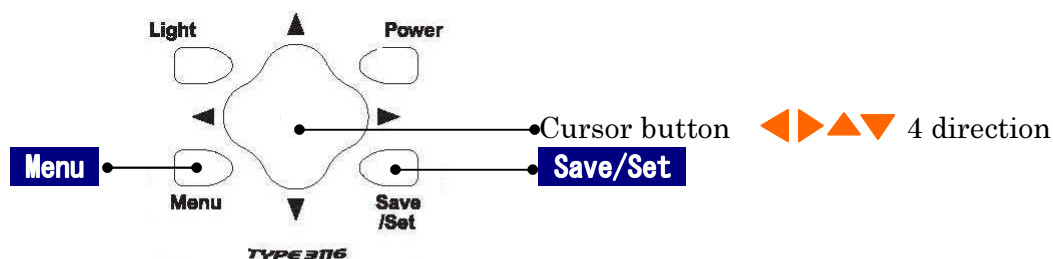

- 2) Select I/O Cursor button ▼ and cursor is moved to a right item by ►.

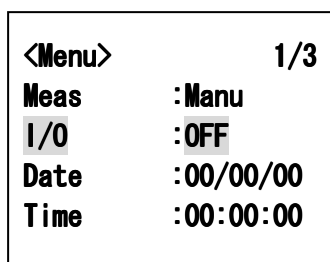

- 3) Select Printer by Cursor button ▲▼ and **Save/Set** by Cursor button .

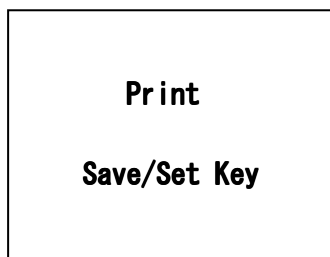

- 3) **Save/Set** Printing is started.

The example of printing of a printer

The example of printing of a printer is shown below.

```

                Vibration Level
001/023 ●————● Address No
00/01/01 00:09
0.05m/s2 RMS

002/023
00/01/01 00:02 ●————● Measurement time : year / month / day
0.05m/s2 RMS                                     hour : minute

003/023
00/01/01 00:02
0.01m/s2 RMS

004/023 ●————● Measurement value
00/01/01 00:02
0.01m/s2 RMS

005/023
00/01/01 00:03
0.07m/s2 RMS

```

Connection with a PC

When connecting a main part and a personal computer by BC-0026 and conversion connector A12-25F-9F (option) as shown in the following figure.

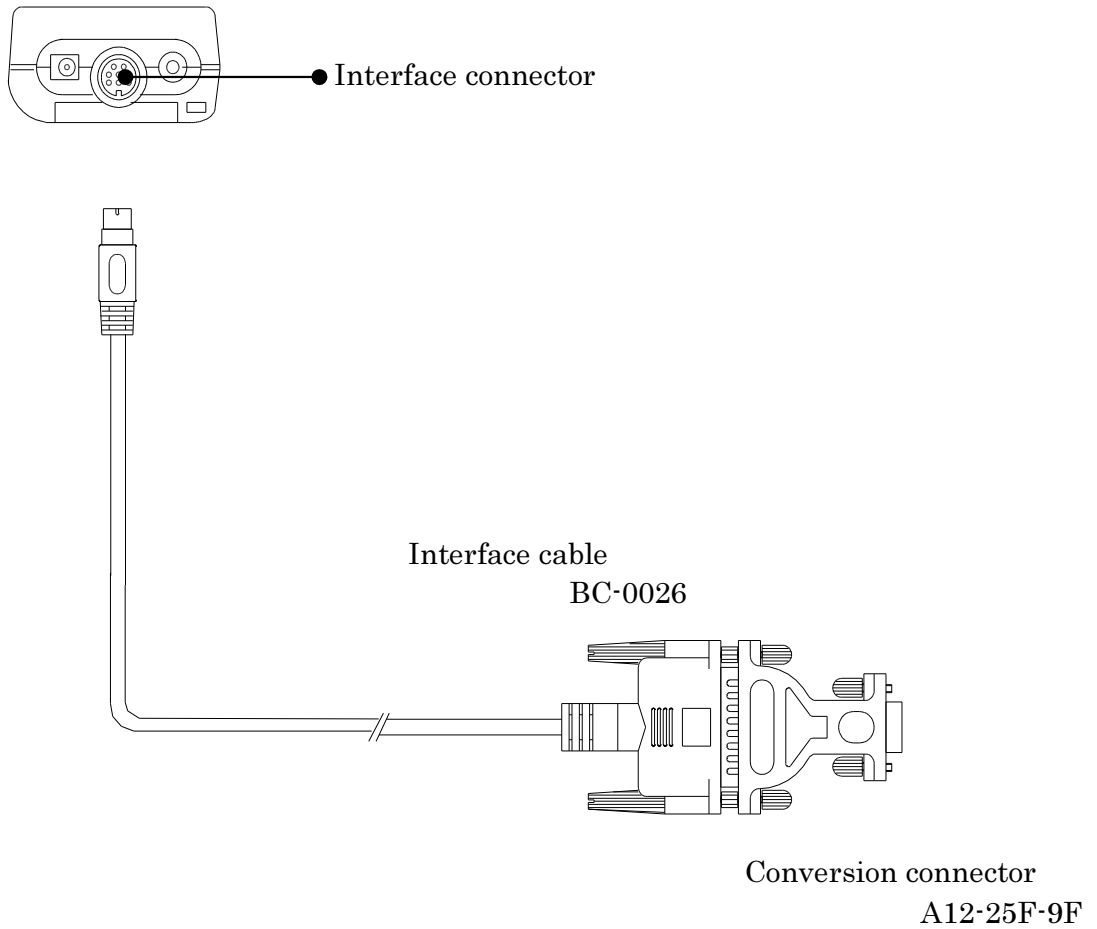

Detail Specification of Communication Command

1. Interface

RS-232C(asynchronous)

Data size ; 8bit
 Stop bit ; 1it
 Parity check ; non
 Transfer Speed ; 4800,9600,19200bps →Selected in MODEL 4200
 Flow control ; non

2. Data Specification

All the data are outputted in ASC II format.

The PC software needs 'Time Out' function.

- ① 001/256 + LF : Measurement No.
 ② 05/07/05□16 : 15 + LF : Measurement date
 ③ 120.2m/s²□RMS+LF + LF : Data

□	: Space (20)
+LF	: Line feed code(0A)

- ·
 ① 002/256 + LF
 ② 05/07/05□16 : 15 + LF
 ③ 02.02m/s²□RMS+LF + LF

<Explanation>

- ① Measurement No. · Saving measurement data
 (Maximum number of saving measurement data : 256) → (001/256 ~256/256)

ex) In the case of ten data : 001/010 Starting with ---
 002/010
 ·
 ·
 010/010 ,and ends.

- ② Calendar for Measuring Time and Date
 year/month/day hour : minute

- ③ Data mode
 <Numeric data>
 2000
 200.0
 20.00

<Measurement mode>
 m/s² (Acceleration)
 μ m (Displacement)
 mm/s (Velocity)

<Data mode>
 Peak
 RMS
 EQPaek
 EQP-P

2. Communication timing

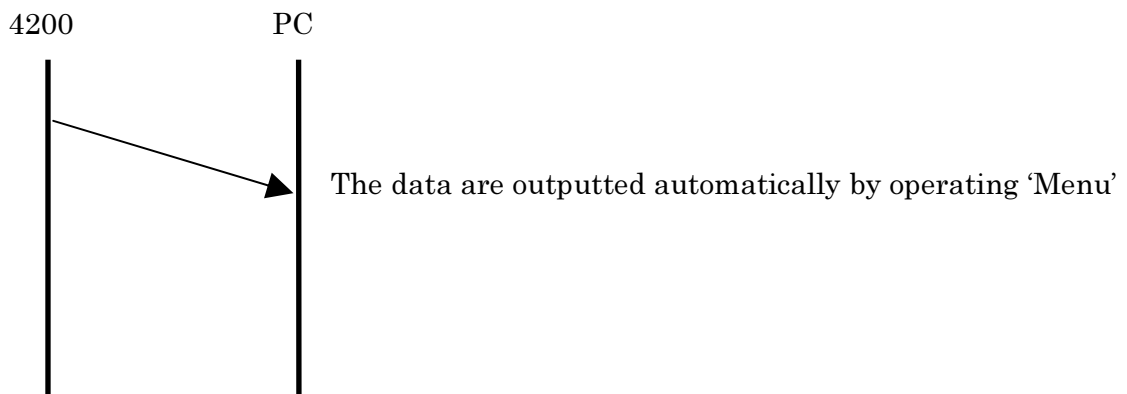

- ① First, start PC application.
- ② Turn on the switch 'Communication' (to wait for data), and click 'Cancel' to terminate the sequence.
- ③ Set the type of I/O and PC listed in 'Menu' of MODEL 4200
- ④ Save the data to PC by Save/Set key.
- ⑤ Confirm the completion of data transfer by checking the last data No.
 ex) 001/256 · · · 256/256 (as in the case of 256 data)
 MODEL 4200 will finish by itself (No handshake)
- ⑥ In the case of data error, cancel the program.

Data managed software

It is possible to manage the data on your PC by using the data handling software.

- Operating system software : Microsoft Windows 2000/XP
- Data sampling and vibration data display for Vibration meter MODEL 4200 through serial data communication.
- The data is stored in CVS form, corresponding to data processing of spreadsheet software.

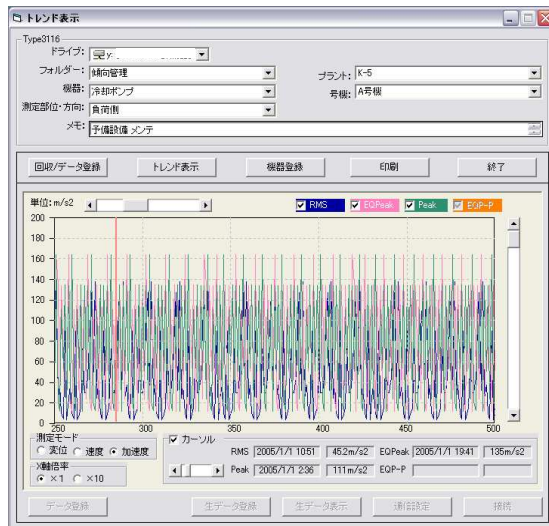

時間	加速度	ピーク		
115.256	2005/1/1 10:57	10	m/s²	PEAK
116.256	2005/1/1 11:03	11	m/s²	PEAK
117.256	2005/1/1 11:09	34	m/s²	PEAK
118.256	2005/1/1 11:15	12	m/s²	PEAK
119.256	2005/1/1 11:20	12	m/s²	PEAK
120.256	2005/1/1 11:26	154	m/s²	PEAK
121.256	2005/1/1 11:32	154	m/s²	PEAK
122.256	2005/1/1 11:37	154	m/s²	PEAK
123.256	2005/1/1 11:43	24	m/s²	PEAK
124.256	2005/1/1 11:49	154	m/s²	PEAK
125.256	2005/1/1 11:55	22	m/s²	PEAK
126.256	2005/1/1 12:01	10	m/s²	PEAK
127.256	2005/1/1 12:06	11	m/s²	PEAK
128.256	2005/1/1 12:12	14	m/s²	PEAK
129.256	2005/1/1 12:18	126	m/s²	PEAK
130.256	2005/1/1 12:24	12	m/s²	PEAK
131.256	2005/1/1 12:29	154	m/s²	PEAK
132.256	2005/1/1 12:35	22	m/s²	PEAK
133.256	2005/1/1 12:41	154	m/s²	PEAK
134.256	2005/1/1 12:47	24	m/s²	PEAK
135.256	2005/1/1 12:53	154	m/s²	PEAK
136.256	2005/1/1 12:59	22	m/s²	PEAK
137.256	2005/1/1 13:04	15	m/s²	PEAK
138.256	2005/1/1 13:10	154	m/s²	PEAK
139.256	2005/1/1 13:16	54	m/s²	PEAK

	A	B	C	D	E	F	G	H	I
1	1	1 001/256	2005/1/1 0:01	134	m/s²	PEAK			
2	1	1 002/256	2005/1/1 0:06	24	mm/s	PEAK			
3	1	1 003/256	2005/1/1 0:12	164	m/s²	PEAK			
4	1	1 004/256	2005/1/1 0:18	22	m/s²	PEAK			
5	1	1 005/256	2005/1/1 0:24	13	mm/s	PEAK			
6	1	1 006/256	2005/1/1 0:29	111	mm/s	PEAK			
7	1	1 007/256	2005/1/1 0:35	54	mm/s	PEAK			
8	1	1 008/256	2005/1/1 0:41	135	mm/s	PEAK			
9	1	1 009/256	2005/1/1 0:47	12	mm/s	PEAK			
10	1	1 010/256	2005/1/1 0:52	134	m/s²	PEAK			
11	1	1 011/256	2005/1/1 0:58	51	m/s²	PEAK			
12	1	1 012/256	2005/1/1 1:04	134	m/s²	PEAK			
13	1	1 013/256	2005/1/1 1:10	24	m/s²	PEAK			
14	1	1 014/256	2005/1/1 1:15	164	m/s²	PEAK			
15	1	1 015/256	2005/1/1 1:21	22	m/s²	PEAK			
16	1	1 016/256	2005/1/1 1:27	13	m/s²	PEAK			
17	1	1 017/256	2005/1/1 1:33	111	m/s²	PEAK			
18	1	1 018/256	2005/1/1 1:38	54	m/s²	PEAK			
19	1	1 019/256	2005/1/1 1:44	135	m/s²	PEAK			
20	1	1 020/256	2005/1/1 1:50	12	m/s²	PEAK			
21	1	1 021/256	2005/1/1 1:56	134	m/s²	PEAK			
22	1	1 022/256	2005/1/1 2:01	51	m/s²	PEAK			
23	1	1 023/256	2005/1/1 2:07	134	m/s²	PEAK			
24	1	1 024/256	2005/1/1 2:13	24	m/s²	PEAK			
25	1	1 025/256	2005/1/1 2:19	164	m/s²	PEAK			
26	1	1 026/256	2005/1/1 2:25	22	m/s²	PEAK			

Specification

Accelerometer MODEL 7812B specification

- 1) Sensor : Voltage output type(built-in pre-amplifier)
- 2) TYPE : 7812B
- 3) Sensitivity : 5.0mV/m/s²(49.1mV/G)±3% at 100Hz
- 4) Transverse Sensitivity : 5% or less
- 5) Frequency characteristics : 1Hz~8kHz
- 6) Constant-current supply : DC7V0.5~4mA
- 7) Temperature range : -10~+60°C
- 8) Size and Weight : 24φ × 50 Approx.60g

Specification

- Measurement range
- Acceleration (ACC) : 0.02~200m/s² RMS
 - Velocity (VEL) : 0.02~200mm/s RMS
 - Displacement (DISP) : 2~2000 μ m EQ p-p
- Frequency range
- Acceleration (ACC) : 3Hz~10kHz
 - Velocity (VEL) : 10Hz~1kHz(Compliant with JIS B0907-1989)
 - Displacement (DISP) : 10Hz~400Hz
- Measurement range
- Acceleration (ACC) : 20, 200m/s² RMS
 - Velocity (VEL) : 20, 200mm/s RMS
 - Displacement (DISP) : 200, 2000 μ m EQ p-p
- Display characteristics
- Acceleration (ACC) : RMS, EQ Peak, Peak
 - Velocity (VEL) : RMS, EQ Peak, Peak
 - Displacement (DISP) : RMS, EQ Peak, EQ p-p Peak
- EQ Peak=RMS× $\sqrt{2}$, EQ p-p=EQ Peak×2
- Dynamic characteristic (Time constant) : RMS, EQ Peak, EQ p-p ; 1s
Peak ; 50msec (rise) / 3s (decay)
- Liquid crystal display
- Display : LCD with backlight 128×64 dot
 - Hold : Data hold
 - Digital display : 4digets, Display Period ; 1s or 2s (selectable)
(Average of 10 data at 100ms, 1s
or 20 data at 100ms, 2s)
 - Bar - graph : 0~100%
 - Warning (Overload) : [Over] is displayed for full scale
- Battery : 4-level residual display
- Data memory : Max.256, 4kB
- Output Terminal : AC on a Menu screen/Portable Headphone Change selection
- AC Output : Output Voltage ; 1Vrms (FS)
Load resistance ; more than 100kΩ
 - Headphone Output : Vibration sound monitor by exclusive Portable Headphone
With Volume function
- Display precision : ±5% (at 9.81m/s² 159.1Hz)
- I/O Terminal : Data output for PC and Direct output to printer
- Interface ; RS-232C
- Operating Temperature : Temperature ; -10~+50°C
- Range Humidity ; 30%~90%(no condensing)
- Battery Type and Life : 2 Alkaline dry cells type LR03, Approx.12 hours or AC adapter
- Consumption current; When AC adaptor is used ; Approx.1.3VA
- Size and Weight : 145(H)×48(W)×23.5(D) Approx.130g(Include Batteries)

Reference 2

Relation between indicated value and AC output

The relation between full scale indicated value and AC output voltage at output terminal, in each Measurement mode and Range, are shown as in the following table.

Measurement mode	Range	Data mode	Full scale indicating value	Output Voltage (Vrms)
ACC	200 m/s ²	RMS	200.0	1.000
		EQpeak	282.8	
		PEAK	282.8	
	20 m/s ²	RMS	20.00	
		EQpeak	28.28	
		PEAK	28.28	
VEL	200 mm/s	RMS	200.0	
		EQpeak	282.8	
		PEAK	282.8	
	20 mm/s	RMS	20.00	
		EQpeak	28.28	
		PEAK	28.28	
DISP	2000 μ m	RMS	707	
		EQpeak	1000	
		EQ p-p	2000	
		PEAK	1000	
	200 μ m	RMS	70.7	
		EQpeak	100.0	
		EQ p-p	200.0	
		PEAK	100.0	

Indicated value and output voltage are in linear relationship.

- ex1) In the case of indicated value 10 m/s² RMS in Range “ACC 20m/s² :
Output voltage = $10 \text{ (m/s}^2) \div 20 \text{ (m/s}^2) \times 1 \text{ (Vrms)} = 0.500 \text{ (Vrms)}$
- ex2) In the case of indicated value 5 m/s² EQpeak in Range “ACC 20m/s² :
Output voltage = $5 \text{ (m/s}^2) \div 28.28 \text{ (m/s}^2) \times 1 \text{ (Vrms)} = 0.177 \text{ (Vrms)}$
- ex3) In the case of indicated value 15 μ m RMS in Range “DISP 200 μ m :
Output voltage = $15 \text{ (} \mu \text{m)} \div 70.7 \text{ (} \mu \text{m)} \times 1 \text{ (Vrms)} = 0.212 \text{ (Vrms)}$

A trouble and the processing method

【Power】

Trouble	Cause	The processing method
This meter does not operate, even if it pushes a switch.	The battery is exhausted.	Exchange Batteries.
	The polarity of a battery is set conversely.	Reset Batteries correctly.
	It was not long-pressing the Power button.	Long-pressing the Power button.
	After battery replacement, if the meter does not operate normally, remove the batteries and insert them again after 5 minutes or more.	

【Display】

Trouble	Cause	The processing method
A display value is	The cable is not connected correctly.	Connect the cable is correctly.
	The Accelerometer is not set correctly.	Set Accelerometer correctly.

【The others】

In addition to this	The processing method
Key operation cannot be performed at all.	Turned off a switch and long-pressing the power button again.
Data and operation are	

How to connect/disconnect the cable

First, when the unit is in operation, turn off the power by pressing the **Power** switch.

- 1) How to connect/disconnect BNC one-touch connector of the curl cable to/from the input terminal of 4200 main body.

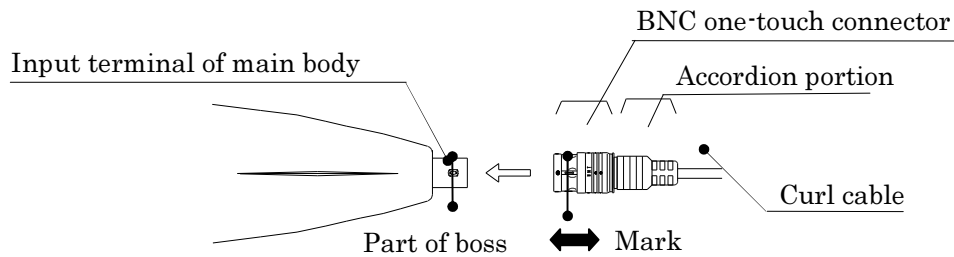

<Connection>

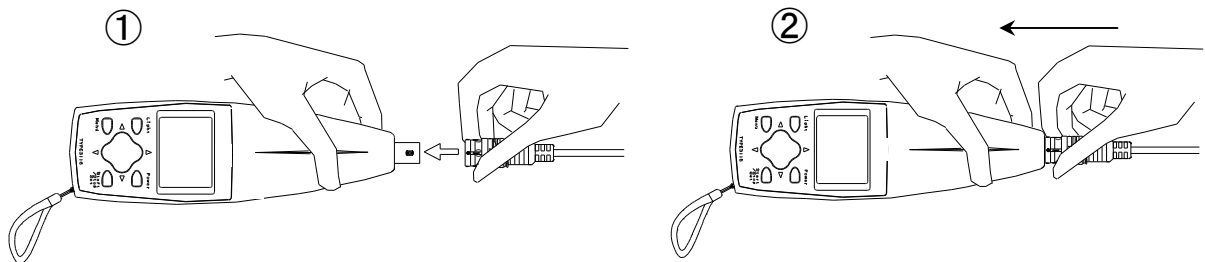

- ① Hold up 4200 main body and BNC one-touch connector of curl cable to fit mark \leftrightarrow of BNC connector to the boss of the main body.
- ② Push straight the BNC one-touch connector into the main body unit it clicks.

<Disconnection>

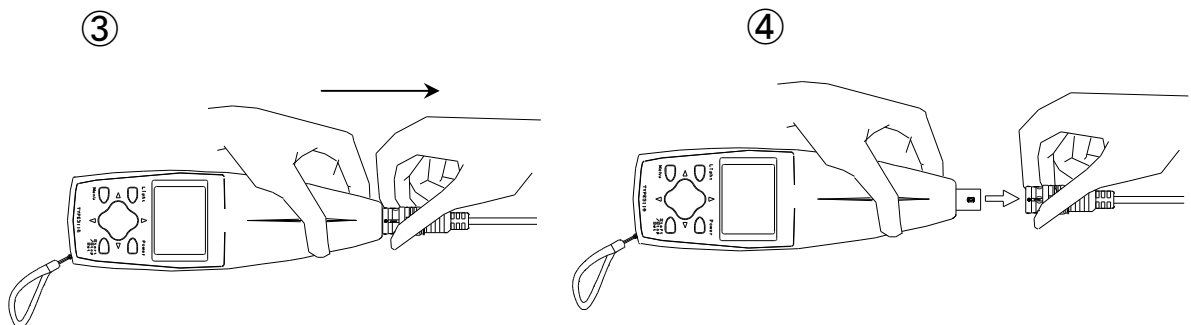

- ③ Hold up 4200 main body and the mark \leftrightarrow portion of BNC one-touch connector of curl cable.
- ④ Draw out straight BNC one-touch connector.

※The connector is one-touch type BNC connector. Do not try to hold up the mark \leftrightarrow portion to disconnect, not the accordion portion or the curl cable itself. Also, during/after connection, make sure you do not try to rotate the connector itself, which may lead to failure or malfunction of any type.

- 2) How to connect/disconnect F-type connector of curl cable.

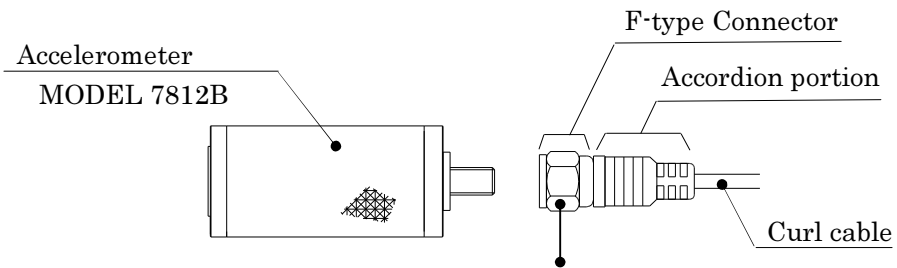

Hold up only F-type connector to turn it clockwise into the Accelerometer.

<Connection>

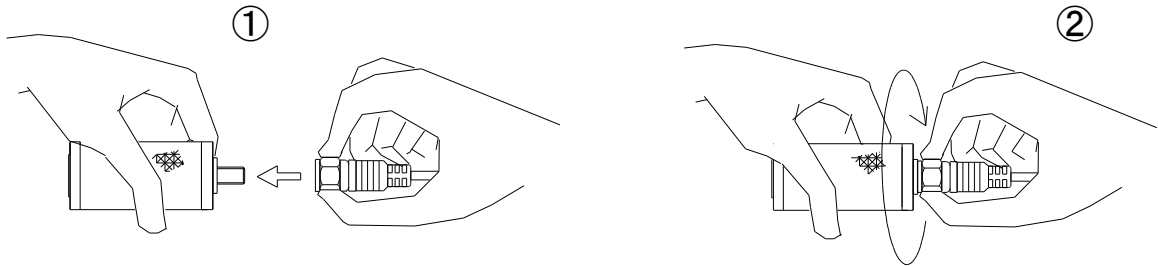

- ① Hold up Accelerometer and F-type connector of curl cable to fit each other.
- ② Hold up only F-type connector to turn it clockwise into the Accelerometer.

<Disconnection>

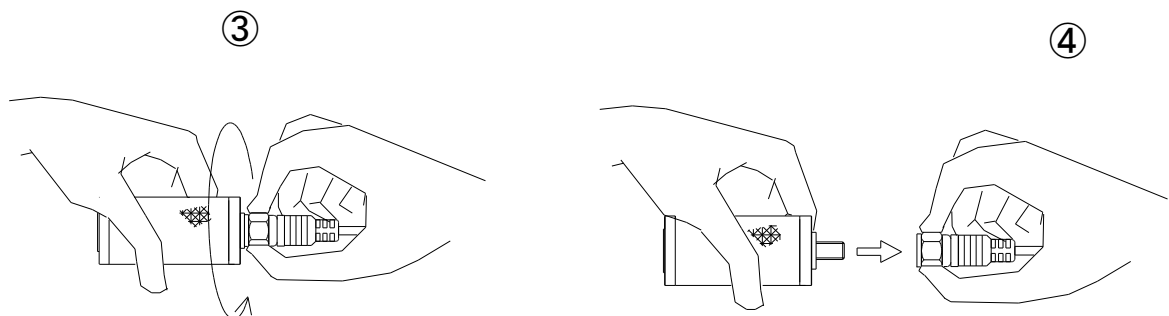

- ③④ Hold up the Accelerometer and turn F-type connector of curl cable counterclockwise until they come free.

※Do try to turn only F-type connector without causing damage to the cable, not to turn or pull the accordion portion or curl cable, which may leads failure or malfunction brought about the breaking of wire.