

aeroqual<sup>®</sup>

# SERIES 200/300/500

## USER GUIDE



# Table of Contents

<b>1</b>	<b>Monitor Components</b>	<b>4</b>
<b>2</b>	<b>Quick Start Guide</b>	<b>5</b>
2.1	Connecting the Battery	5
2.2	Charging the Battery	6
2.3	Connecting the Sensor Head	6
<b>3</b>	<b>Sensor Heads</b>	<b>7</b>
3.1	Sensor Head Technology	7
3.2	Sensor Head Variants	8
3.3	Sensor Head Warm-Up	9
3.4	Sensor Head Failure Modes	9
<b>4</b>	<b>Monitor Operation</b>	<b>10</b>
4.1	Powering On/Off and Standby	10
4.2	Menu Functions	11
<b>5</b>	<b>Aeroqual Monitor Software (Series 500)</b>	<b>17</b>
5.1	Computer Requirements	17
5.2	Connect to Monitor	17
5.3	Monitor Setup	17
5.4	Data Logging	18
<b>6</b>	<b>External Control Wiring (Series 300 &amp; 500)</b>	<b>22</b>
6.1	Wiring for Alarm	22
6.2	Wiring for Control	23
6.3	Wiring the 0-5 V Analogue Output	23
<b>7</b>	<b>Calibration</b>	<b>24</b>
7.1	Calibration FAQ's	24
7.2	Calibration Certificate	26
7.3	Calibration Accessory	26
7.4	Bump Test	27
7.5	Zero Calibration	27
7.6	Span Calibration (Series 300 and 500)	28
7.7	Health and safety during calibration	29
<b>8</b>	<b>Specifications</b>	<b>32</b>
8.1	Dimensions	33
<b>9</b>	<b>Optional Accessories:</b>	<b>34</b>
9.1	Temperature and Relative Humidity Sensor (HH TRH)	34
9.2	Handheld Enclosure (HH ENC)	34
9.3	Remote Sensor Head Adaptors (AS R10 / AS R13)	36
<b>10</b>	<b>Troubleshooting</b>	<b>37</b>

10.1	Sensor Failure .....	39
<b>11</b>	<b>Technical Support .....</b>	<b>39</b>
<b>12</b>	<b>Care and Maintenance .....</b>	<b>40</b>
12.1	Disposal / Recycling .....	40
<b>13</b>	<b>Appendix .....</b>	<b>41</b>
13.1	General Guidelines on the Measurement of Gases .....	41
13.2	Specific Guidelines on the Measurement of Ozone .....	42
13.3	Sensor Characteristics .....	43
13.4	Gas Sensitive Electrochemical (GSE) Sensor - Ozone .....	44
13.5	Gas Sensitive Electrochemical (GSE) Sensor - Other .....	45
13.6	Particulate Matter Sensor Head PM10 / PM2.5 sensor .....	47
13.7	Volatile Organic Compound (VOC) sensors .....	49
<b>14</b>	<b>Copyright .....</b>	<b>55</b>
<b>15</b>	<b>Software License.....</b>	<b>55</b>
<b>16</b>	<b>Terms and Conditions .....</b>	<b>55</b>
<b>17</b>	<b>Statements of Compliance .....</b>	<b>56</b>

# 1 Monitor Components



The following components are supplied with each monitor:

Component	Series 200	Series 300	Series 500
Monitor base			
Sensor head (If ordered)			
12 VDC AC/DC Lithium Smart Charger			
Battery pack – 11.1V Lithium Polymer			
USB to monitor cable			
Two-way PS2 adapter cable			

**NOTE:** Data logging software for the Series 500 can be found at:

<https://www.aeroqual.com/support/product-software>

Please check that all these components have been supplied, if any of the components are missing, contact your distributor, or Aeroqual at: [sales@aeroqual.com](mailto:sales@aeroqual.com).

Replacement batteries, sensor heads and other accessories can be purchased separately.





## 2 Quick Start Guide

The following actions need to be completed before the monitor is ready for use:

1. Connect the battery.
2. Charge the battery.
3. Connect the sensor head.

### 2.1 Connecting the Battery

The battery is shipped installed in the monitor but disconnected. Follow the steps below to connect the battery.

			
<p>Push tabs on both sides in.</p>	<p>Holding in both tabs pull the blue battery cover upwards. If it is difficult to move then you may be squeezing too tight.</p>	<p>With the cover removed the battery is visible. Push the base of the battery forward to clear the clips at the bottom.</p>	<p>The battery is shipped unplugged.</p>
			
<p>Insert the connector and firmly depress.</p> <p>Gently tug on the wires to ensure the plug does not come free.</p>	<p>Reinsert the battery by locating the top right hand corner under the top right tab.</p>	<p>Push down the top left side of the battery, position the battery into place under the clips at the bottom.</p>	<p>Re-engage the top hinge of the cover, swing down and shut, ensuring tabs lock cover into place.</p>

## 2.2 Charging the Battery

### ⚠ IMPORTANT

- Switch off the monitor before removing the sensor head
- Do not use the battery pack for any other purpose than operating the Aeroqual monitor
- Do not disassemble or deface the batteries as this may cause burns
- Do not incinerate or heat as this may cause burns, the batteries may burst or cause the release of toxic materials
- Do not short circuit as this may cause burns
- Use only batteries approved by Aeroqual and recharge your battery only with the AC/DC adaptor supplied with the instrument
- Never use any charger or battery that is damaged or worn out
- Batteries must be recycled or disposed of properly. They must not be disposed of in municipal waste
- Never charge the battery in a hermetically sealed container
- Perform charging at temperatures between 0 °C to 45 °C

With the adaptor plugged in and monitor off allow 3 hours for the battery to fully charge.

A new battery's full performance is achieved only after a number of complete charge and discharge cycles. A fully charged battery will run for approximately 8 hours depending on the sensor head being used.

### Smart Charger LED Status

- **Red** LED = Battery is charging OR battery is fully charged and monitor is on.
- **Green** LED = Battery is fully charged and monitor is off.

**NOTE:** The unit can be charged when switched on but it will charge more slowly. The battery can be charged with the sensor head installed or removed from the base.

## 2.3 Connecting the Sensor Head

### ⚠ IMPORTANT

- Do not insert/remove the sensor head while the monitor is switched on. This may damage the unit. If the sensor head is removed under these conditions without AC/DC adapter connected, the unit will automatically shut down.
- Always place the sensor head perpendicular to the air flow to avoid damage to the sensor.
- Sensors require a warm-up period before operation, refer to Section 3.3.
- To avoid damage to the sensor, do not shake or invert the monitor when a sensor is attached.

Sensor heads have a keyed connector and are shaped to ensure correct insertion into the monitor base. When the sensor is fully inserted you can turn on the monitor. Sensors require a warm-up period before operation, refer to Section 3.3.

### 3 Sensor Heads

#### ▲ IMPORTANT

- Do not insert/remove the sensor head while the monitor is switched on. This may damage the unit. If the sensor head is removed under these conditions without AC/DC adapter connected, the unit will automatically shut down.
- Always place the sensor head perpendicular to the air flow to avoid damage to the sensor.
- Sensors require a warm-up period before operation, refer to Section 3.3.

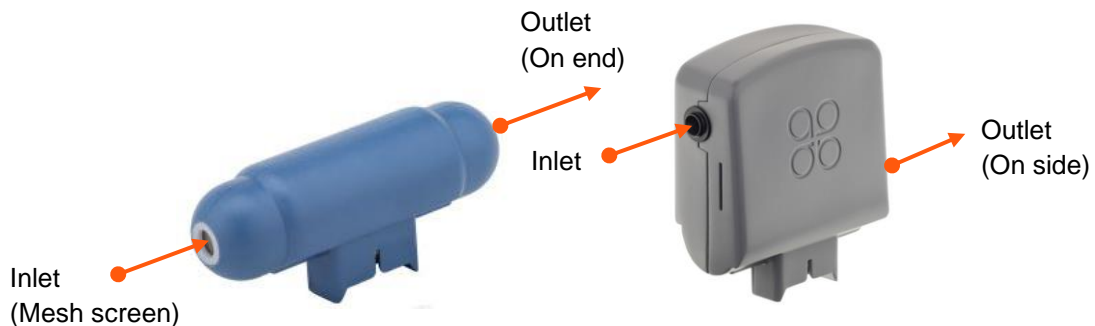

#### 3.1 Sensor Head Technology

Aeroqual sensors are as unique as the monitors and accessories they are compatible with. Below are the different sensor technologies and the designs you may encounter.

Type	Description	Design
GSS	Our gas sensitive semiconductor (GSS) sensor uses proprietary sensing material, built in automatic baseline correction (ABC) and interference rejection. This combination results in ppb resolution and a highly linear response.	
GSE	Our gas sensitive electrochemical (GSE) sensors generate nano-amp currents proportional to the gas concentration. Aeroqual uses low noise electronics to capture these signals resulting in low detection levels.	
LPC	Our laser particle counter (LPC) for Particulate Matter (PM) measurements uses optimized signal processing using low noise electronics, we add algorithms to correct for interferences, e.g. humidity.	
NDIR	Our non-dispersive infrared (NDIR) sensor uses infra-red light, a narrow band-pass filter and photodiode to measure the intensity of light at the gas absorption band. The light intensity is proportional to the gas concentration.	
PID	Our photoionization detector (PID) sensor uses a krypton filled UV lamp to ionize VOC gas molecules and generate a current that is proportional to the VOC concentration. The PID sensor responds to a wide range of VOCs and is industry recognized.	

All sensors in the portable range benefit from active sampling and come factory calibrated.

**NOTE:** Sensor head colours vary by gas type, not all colours are shown in the table above.

### 3.2 Sensor Head Variants

Sensor heads come in a variety of shapes and configurations to suit different gases and accessories.



Sensor Head Type 1

**Compatible with:** Series 200 / 300 / 500 Standard Remote Sensor Kit and Series 900 fixed monitors

**Not compatible with:** Industrial Enclosure, and IP 41 Remote Sensor Kit



Sensor Head Type 2

**Required for:** Industrial Enclosure, and IP41 Remote Sensor Kit and Series 930 fixed monitors



Sensor Head – Carbon Dioxide

**Compatible with:** Series 200 / 300 / 500 Standard Remote Sensor Kit

**Not compatible with:** Industrial Enclosure, and IP 41 Remote Sensor Kit



Sensor Head – Particulate Matter

**Compatible with:** Series 200 / 300 / 500 Standard Remote Sensor Kit

**Not compatible with:** Industrial Enclosure, and IP 41 Remote Sensor Kit



Sensor Head Type 4

**Required for:** Series 940 fixed monitors only



### 3.3 Sensor Head Warm-Up

When the monitor is switched on the sensor needs to warm up to burn off any contaminants, there are two stages:

- 3 minutes; sensor WARMING UP, no measurement
- 7 minutes; sensor stabilising, measurement is flashing

When not being used, keeping the monitor in 'standby' mode will keep the sensor heated and prevent a build-up of contaminants.

If the sensor is new (or unused for long periods) it can take up to 24 hours for the message WARMING UP (or SENSOR FAILURE in older models) to disappear. Should the message remain after this time, a genuine sensor failure may have occurred, see Section 10.

For an ozone sensor, 24 hours is a conservative time to burn off contaminants and achieve its stated performance specification. In most instances this will be achieved well within 24 hours. The warm-up period can be reduced by subjecting the sensor to elevated ozone levels for a short period. For example, 0.1 ppm of ozone for 5 minutes typically reduces the warm-up time to < 30 minutes.

### 3.4 Sensor Head Failure Modes

There are two possible sensor failure modes that will be indicated on the display:

- **SENSOR FAILURE, REPLACE SENSOR**  
The sensor head should be replaced as there has been a component failure.
- **SENSOR AGING** (Ozone Low/Ultra Low sensor heads only)  
The sensor has reached the end of its usable life, the measurement readings can no longer be relied upon to be within specification.

See also Trouble shooting in Section 10.

## 4 Monitor Operation

The following instructions detail the operation and set up of the monitor:

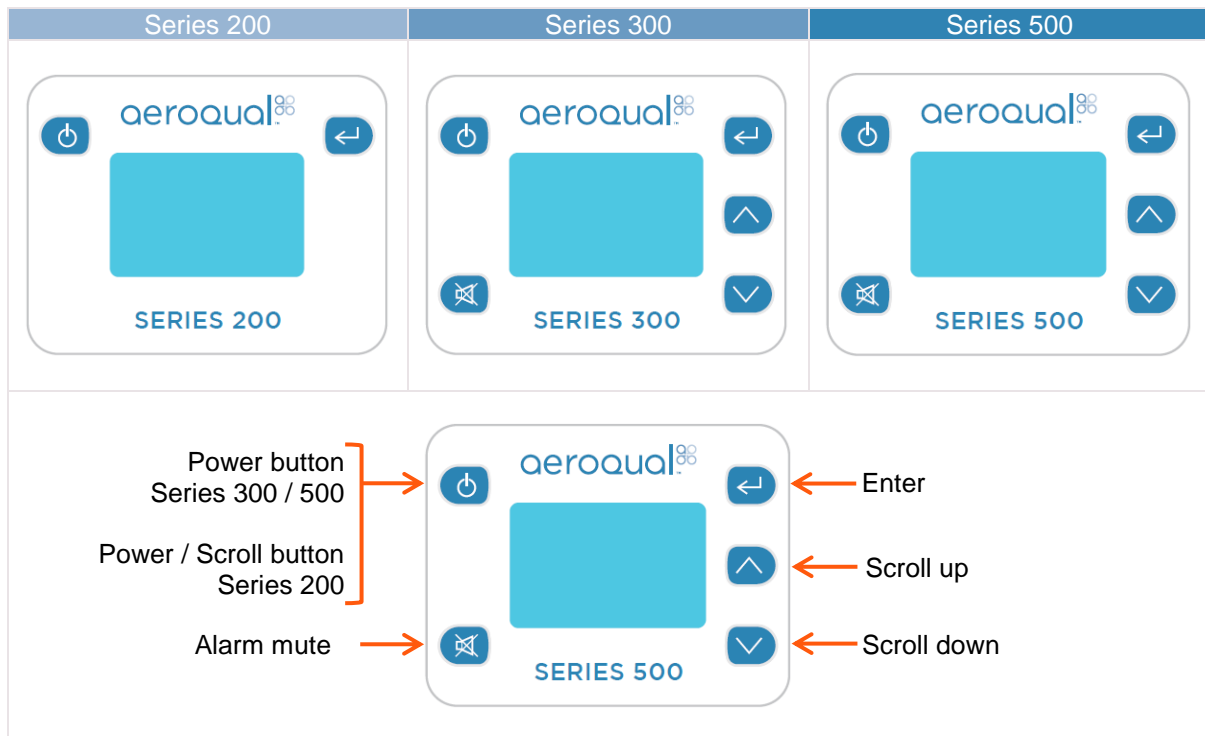



### 4.1 Powering On/Off and Standby

**To turn the monitor on:** Press and hold the power button  until the screen activates. The monitor will turn on and the display will appear as below:



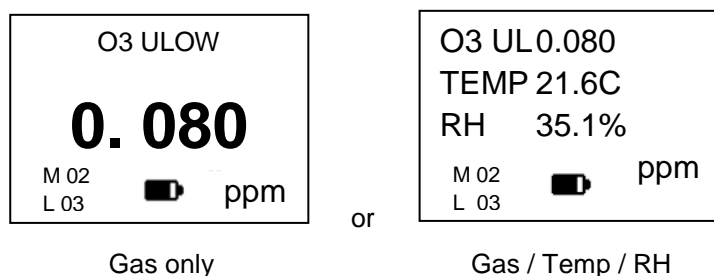

After 5 seconds the display will change to indicate the type of sensor head and the monitor will enter WARMING UP mode (see Section 3.3), after which the main display will appear as below:



- The battery indicator  does not represent the remaining battery life.
- **M** and **L** (Monitor ID and Location ID) only show on the Series 300 and 500.
- Only 3 parameters can be shown on the screen at one time. If a sensor captures more than one parameter (e.g. PM<sub>2.5</sub>/PM<sub>10</sub> sensor head) they will scroll up the screen.

**To turn the monitor off:** Press and hold the power button  for 2 seconds until the monitor beeps. The display will now be blank and operation of the monitor will cease.

**To activate standby mode:** With the monitor on, press the power button  once. This will stop operation of the monitor; however the sensor will be kept warm.



This mode is used to conserve power between operations but keep the sensor ready to measure the gas concentration with only a short warm-up phase needed. In this mode the display will show the sensor type and standby symbol .

To return the monitor to operational mode press the power button .

**NOTE:** When using a Carbon Dioxide sensor head in standby mode, the sensor runs at full power and the fan remains on.

## 4.2 Menu Functions

Use the enter button  to enter the SETUP menu.

Use the scroll up  and scroll down  buttons to navigate, select options, and change values.

Use the enter button  to confirm the selections and changes.

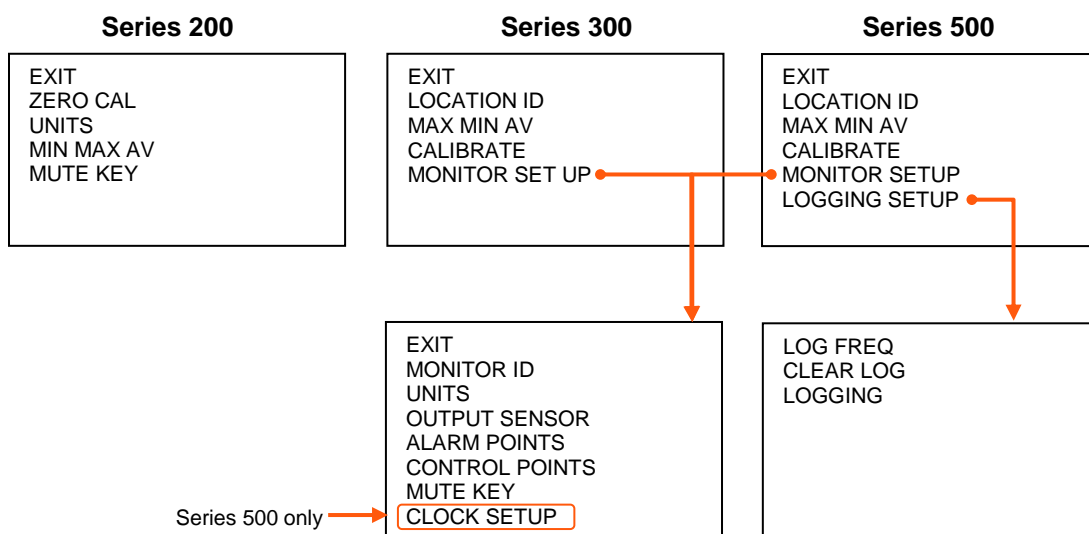



To exit a menu; complete the action for the menu you are in, or scroll to **EXIT** and press enter . Each menu item is covered in the following sub-sections.

### 4.2.1 ZERO CAL

See section 7.4

### 4.2.2 UNITS

In the Series 300 and 500, UNITS is found under MONITOR SETUP. Use the scroll up  and scroll down  buttons to select the required units, press enter  to confirm the selection.

- ppm or mg/m<sup>3</sup> for gases
- mg/m<sup>3</sup> for particulate matter (PM) only

If a temperature and humidity sensor is attached, choose from:

- °C or °F



### 4.2.3 MAX MIN AV

When activated, MIN MAX AV displays the minimum, maximum and average readings from the start of the measurement cycle.

To activate:

- Select MAX MIN AV
- Select START to initiate the measurement cycle and return to the setup menu
- Scroll to EXIT to return to the main display
- The readings will scroll up the screen

**NOTE:** Only three parameters will be shown on the screen at one time.

In the Series 300 and 500, the MAX MIN AV cycle can also be initiated from the main display by holding down the scroll down button  for 2 seconds until the unit beeps. Hold down the scroll down button  again for 2 seconds to stop the measurement cycle.



When the MAX MIN AV cycle is initiated, the display should read as seen below:

O3 UL		O3 UL	TEMP	RH	
	PPM		PPM	C	%
RD	0.010	RD	0.010	23	50
MIN	0.005	MIN	0.005	22	50
MAX	0.024	MAX	0.024	25	56
AVE	0.015	AVE	0.015	24	54

or

**NOTE:** The RD value is the current reading. The speed of the display scrolling is dictated by the slowest sensor. The display will scroll every time a new set of readings have been taken.

#### 4.2.4 ZERO CAL / CALIBRATE

Select ZERO CAL on the Series 200, or CALIBRATE on the Series 300 and 500. Then to enter the CALIBRATE menu, hold down the mute button  and scroll down button  for 2 seconds. ZERO CAL or SPAN CAL can be selected.

For information on how to calibrate the sensor heads please refer to Section 7.

#### 4.2.5 MUTE



Mute silences the audible feedback 'beeps' that occur when you press a button.

- Select MUTE KEY (Series 200) or under MONITOR SETUP (Series 300 and 500).
- Press the enter  to silence the audible feedback 'beeps', the word MUTED will appear next to MUTE KEY.

**NOTE:** On the Series 200, if the device is turned off the mute settings will be returned to the default state and mute will have to be reset when the monitor is restarted.



#### 4.2.6 LOCATION ID (Series 300 & 500)

The location ID provides a means of identifying the location where a measurement was taken. This can be used to quickly trace a measurement back to a location. Location ID is logged for each measurement.

- Select LOCATION ID under MONITOR SETUP.
- Use the scroll up  and scroll down  buttons to select the required ID.
- Press enter  to confirm the ID and return to the setup menu.

#### 4.2.7 MONITOR ID (Series 300 & 500)

Each monitor can be numbered to identify them quickly when more than one is in use. Data is tagged with the monitor ID at the time it is downloaded to the PC, so you can use more than one monitor with a single instance of PC software (S500 only). Each record in the database contains the following; date, time, monitor id, location id, sensor type, sensor reading.



- Select MONITOR ID under MONITOR SETUP
- Use the scroll up  and scroll down  buttons to select the required ID
- Press enter  to confirm the ID and return to the setup menu

In the Series 500 data logging mode, only the Location ID will be logged. The monitor ID is loaded to the database at the time of data upload (where it is logged).

**NOTE:** For compatibility purposes the database records for earlier versions of the S500 (v5.x) default to monitor ID = 1 and location ID = 1. This cannot be changed.









#### 4.2.8 OUTPUT SENSOR (Series 300 & 500)

The output sensor selection will determine which sensor parameter the alarm, control points and buzzer refer to.

- Select OUTPUT SENSOR under MONITOR SETU
- Use the scroll up  and scroll down  buttons to select the required parameter
- Press enter  to confirm the selection and return to the setup menu





**NOTE:** The 0-5v analogue signal will also operate on the selected sensor and measurement range.

#### 4.2.9 ALARM POINTS (Series 300 & 500)

- Select ALARM POINTS under MONITOR SETUP, ALARM HI will display
- Use the scroll up  and scroll down  buttons to select the required high concentration
- Press enter  to confirm the change, ALARM LO will display
- Use the scroll up  and scroll down  buttons to select the required low concentration
- Press enter  to confirm the change, BUZZER display will display
- Use the scroll up  and scroll down  buttons to enable or disable the alarm
- Press enter  to confirm the selection and return to the setup menu







If the alarm is disabled a P will show on the right hand side of the alarm mute symbol on the main display, highlighting that the alarm has been permanently muted.

Alarms indication:



- ALARM HI =  accompanied by a fast beeping sound
- ALARM LO =  accompanied by a slow beeping sound

The alarm can be muted by pressing the mute button  on the display screen. However, this is only a temporary mute and will only mute the alarm during that specific alarm condition. Once the concentration has moved back into the alarm limits the settings will reset. To turn off the mute permanently follow instructions to disable the alarm in Section 4.2.5.

#### 4.2.10 CONTROL POINTS (Series 300 & 500)

- Select CONTROL POINTS under MONITOR SETUP, CONTROL HI will display
- Use the scroll up  and scroll down  buttons to select the required high concentration
- Press enter  to confirm the change, CONTROL LO will display
- Use the scroll up  and scroll down  buttons to select the required low concentration
- Press enter  to confirm the selection and return to the setup menu

#### 4.2.11 CLOCK SETUP (Series 500)



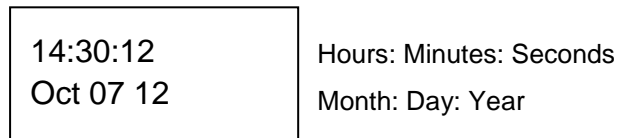





- Select CLOCK SETUP under MONITOR SETUP, HOUR will display,
- Use the scroll up  and scroll down  buttons until the correct hour is displayed
- Press enter  to confirm the change, MINUTES will display
- Repeat steps for seconds, month, day and year



**NOTE:** The clock is a 24 hour clock (e.g. 14:30 = 2:30 pm)



#### 4.2.12 LOGGING SETUP (Series 500)

The Series 500 monitor can log up to 8188 data points divided by the number of parameters being logged. Parameters include; gas sensors, temperature and optional relative humidity sensor and for the PM sensor PM2.5 and PM10 are treated as separate parameters.

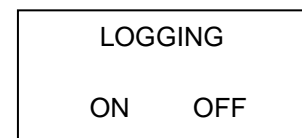
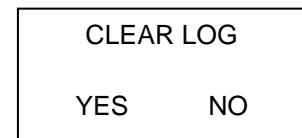
- Select LOGGING SETUP under MONITOR SETUP, LOG FREQ 1 MIN will appear on the display.
- Use the scroll up  and scroll down  buttons to select the required frequency in 1 minute intervals
- Press enter  to confirm the selection, CLEAR LOG will display
- Use the scroll up  and scroll down  buttons to select YES or NO
- Press enter  to confirm the selection, LOGGING will display
- Use the scroll up  and scroll down  buttons to select ON or OFF
- Press enter  to confirm the selection and return to the setup menu





#### Logging short cuts

- The data log can also be cleared directly from the main display screen by holding down the mute button  for 2 seconds until the monitor beeps (if the monitor keys are not muted).
- Data logging can also be both started and stopped directly from the main display screen by pressing the scroll up button  for two seconds until the monitor beeps (if the monitor keys are not muted).

## Logging indicator

When data logging is initiated a triangle  will appear on the main display screen. The triangle is an indication that data logging is active, and is also used as an indication of the presence of data, as below:

-  An empty triangle indicates that no data is stored
-  A filling triangle indicates that some data is stored in the memory. The triangle will fill up in 10% increments.
-  A full triangle indicates that the memory is full and needs downloading to the PC.

For direct logging to a PC using Aeroqual Monitor Software refer to Section 5.4.



## 5 Aeroqual Monitor Software (Series 500)



Aeroqual Monitor Software for the Series 500 is available for free download from the Aeroqual website: <https://www.aeroqual.com/support/product-software>

### 5.1 Computer Requirements

- USB to monitor cable (supplied with the Series 500)
- Window OS version 2000 or later required – iOS platforms are not supported
- 512 Mb RAM or more recommended
- 1 GHz processor speed or faster recommended

**NOTE:** S500 V6.5 software will support Series 500 monitors with firmware S500 V5.x, earlier versions are incompatible.

### 5.2 Connect to Monitor

- Connect the Series 500 monitor to a computer using the cable supplied and turn on
- Launch the Aeroqual Monitor PC software and click  on the toolbar to search for the monitor. The unit will be detected automatically and connect
- Test the connection by clicking  on the tool bar. This will display the Monitor Name, Version and ID Number

### 5.3 Monitor Setup

The Software can be used to setup the following on the Series 500 monitor:

- Monitor ID
- Location ID
- Units
- Logging Frequency
- Output Sensor
- Alarm Settings
- Control Settings
- Clock

To setup:

- **Monitor → Setup** (or Ctrl P), the Monitor Setup dialog box will appear
- Type in, or scroll up or down to set the desired values
- Click the 'Save' button to synchronise the monitor values with those on the PC
- In order to log data it is essential that the clock on the monitor is set to the real time. Click 'Update Clock'. This can also be done on the monitor (Section 4.2.11)

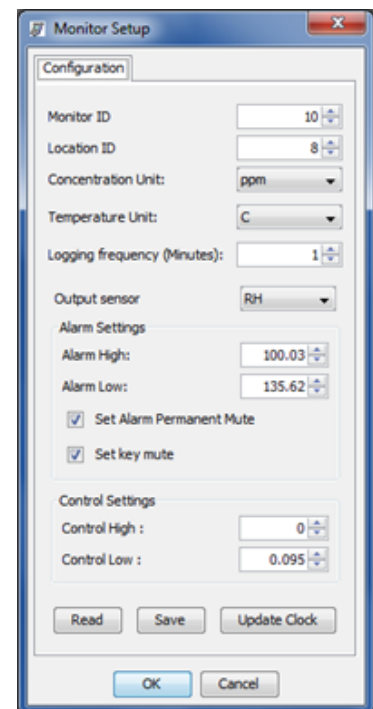



**NOTE:** If the temperature and humidity sensor is connected, an option to select Temperature unit will appear.

## 5.4 Data Logging

The Aeroqual Monitor Software can be used to log data directly from a Series 500 monitor to a PC. For instructions on how to log data on the monitor itself, refer to Section 4.2.12.

### 5.4.1 PC Data Logging

Ensure that the USB cable is connected to the monitor and to the PC. Click **File** → **Start PC Data Logging**, or click  on the toolbar. The data will be logged directly to the database on the PC. No data will be stored on the monitor memory in this mode of operation. However, if PC data logging is stopped by clicking  on the toolbar, the data will start to be stored in the Series 500 monitor memory.

### 5.4.2 Downloading Logged Data from Series 500

Logged data from the monitor memory can be downloaded by clicking **File** → **Download Logged Data** or by clicking  on the toolbar. A data download progress bar will appear while the data is downloading.

If for any reason, the data download does not complete, is terminated or stops:

- Turn off the monitor to prevent any data loss.
- Delete the data that has been downloaded to the PC
- Close the PC software program and repeat the downloading process with the monitor on, connected and with the PC software running.

**NOTE:** Downloaded data will not be removed from the monitor memory. To delete the logged data from the monitor refer to Section 4.2.12.

### 5.4.3 Graphs

While logging directly to a PC, the Real Time View Graph or the Logged Data Graph can be accessed via 'Data' on the menu bar. Logged data graph can be viewed by clicking **Data** → **Graph** → **Logged Data**. Each parameter is shown in individual tabs.

#### To Configure graphs:

- → **Graph** → **Default Style** or by right clicking on the graph and selecting 'Graph Style'

#### To zoom in:

- Click on the graph and drag to create a yellow rectangle. The yellow rectangle shows the selected area the graph will zoom into.

#### To save graphs:

- Right click on the graphs to save or print. Graphs will be saved as a JPG file

#### To reset the graph to the default:

- Right click and select 'Reset to Default'

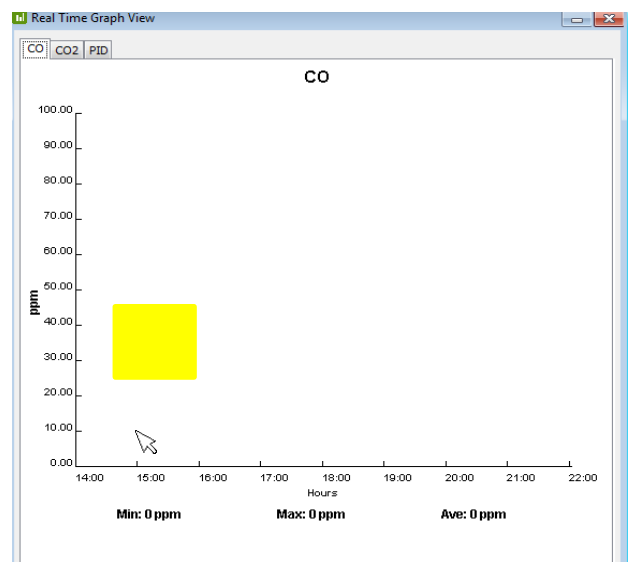

In the Logged Data Graph the date, time and sensor type to be viewed can be selected. The Monitor and Location ID can also be selected.

**NOTE:** The Monitor ID is not logged on each record in the monitor but will be stored in the database against each measurement when the data is downloaded. The data will be tagged with whatever the monitor ID is at the time of download. Conversely, the location ID is logged on each record in the monitor.

#### 5.4.4 Tables

While logging directly to a PC, the **Real Time Table View** or **Logged Data Table View** can be accessed via the **Data** menu on the menu bar.

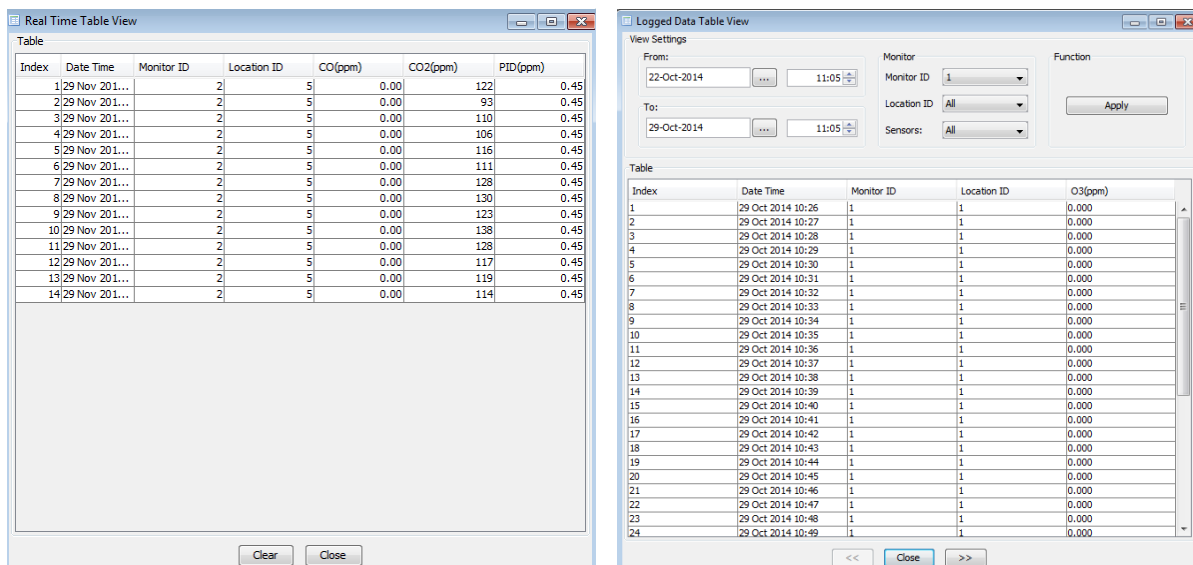

In the logged data table view the date, time and sensor type can be selected to view the relevant data. The Monitor and Location ID can also be selected. Once these parameters have been selected click 'Apply' to filter the data and display the selected parameters.

The logged data table will display up to 7 days of data on each page. Click the arrows  at the bottom of the table to view the previous or next 7 days of data within the filtered data set.

**NOTE:** Only one monitor ID can be viewed at a time in the logged data table view.

### 5.4.5 Daily View

This is a summary for each day, from midnight to midnight, of the Minimum, Maximum and Average readings over the 24 hour period. To launch the Daily View window:

- **Data → Daily Analysis**
- Select the date range, monitor and location ID and click 'Apply' or click 'View All'
- Click 'Export' to export summary data files to programs such as MS Excel.

**NOTE:** Only one monitor ID can be viewed at a time in the daily view table.

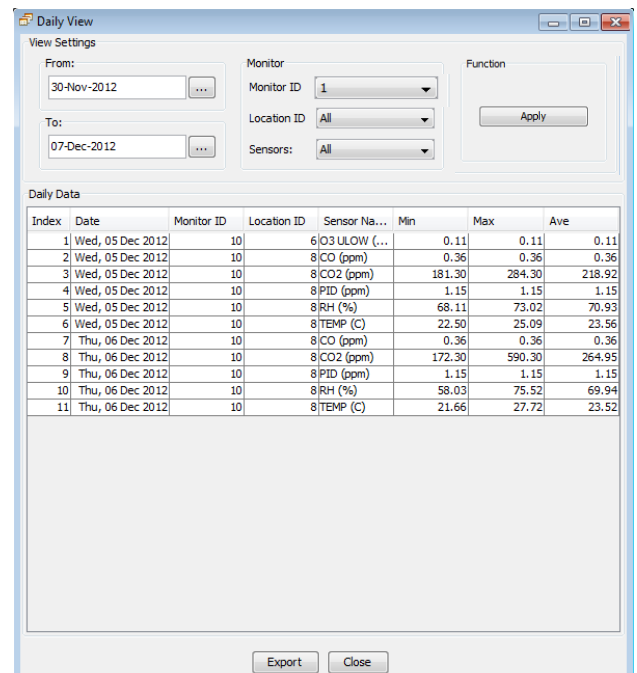

### 5.4.6 Exporting Data

To export the database:

- **File → Export Logged Data**
- Select the range of data to be exported using the date, time, monitor ID, location ID and sensor type parameters
- Click 'Export', select a directory, choose a file format (either plain text or MS Excel file)
- Click 'Save' to export the data to the chosen location

**NOTE:** Only one monitor ID can be exported at a time. Up to 50,000 lines of file can be exported at once. If more than 50,000 lines need to be exported it will need to be carried out in two exports.

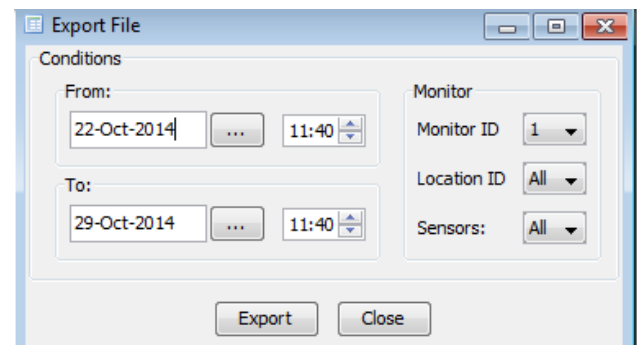

### 5.4.7 Deleting Data

To delete data in the database:

- **File → Database Management → Delete Data.**
- Select the range of data to be deleted using the date, time, monitor ID, location ID and sensor type parameters
- Click 'Delete'. A warning notice will appear confirming the data set to be deleted. Click yes to delete the data.

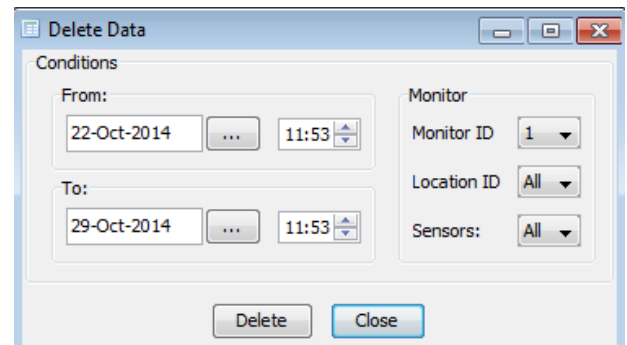

**NOTE:** Only data from one monitor ID can be deleted at a time.

### 5.4.8 Zipping Data

To archive logged data:

- **File → Database management → Zip Database**
- Select a directory to back up all the current stored data to a zipped file.

To view archived logged data:

- **File → Database management → Unzip Database**
- Select the zipped file and click OK.
- View and analyse data as required (Data → Table → Logged)

**NOTE:** Do not view archived data on the same PC being used for data logging; logging will be stopped and the current data in the database will be lost unless it has been zipped.

## 6 External Control Wiring (Series 300 & 500)

The pin numbers for the external output connector are numbered from 1 to 6. Pin 1 is the closest pin to the power jack.

The pin designations are as follows:

1. 12 V DC
2. Analogue output 0-5 V
3. Control
4. High alarm
5. Low alarm
6. Ground



The RJ12 connector offers two possibilities for wiring, either a switch to GND or a 12V output.

- If the 12V output is used, the power for the relay coil is supplied by the Aeroqual AC/DC adaptor. In this case, ensure that the relay coil does not draw more than 150mA and that a protection diode is inserted across the relay coil.
- If the switch to GND output is used, ensure that the relay coil does not draw more than 150mA, that the voltage does not exceed 24V and that a protection diode is inserted across the relay coil.

### 6.1 Wiring for Alarm

The high alarm and low alarm pins can be wired to supply simple on / off switching to operate equipment which requires only an on or off signal, such as an alarm.

- To switch to GND, wire to pins 4, 5 and 6.
- To switch to 12V output, wire to pins 4, 5 and 1

**NOTE:** Wiring for alarm will only operate while the Series 500 is powered by the AC adaptor.

The following diagram is a typical wiring for a high gas level alarm.

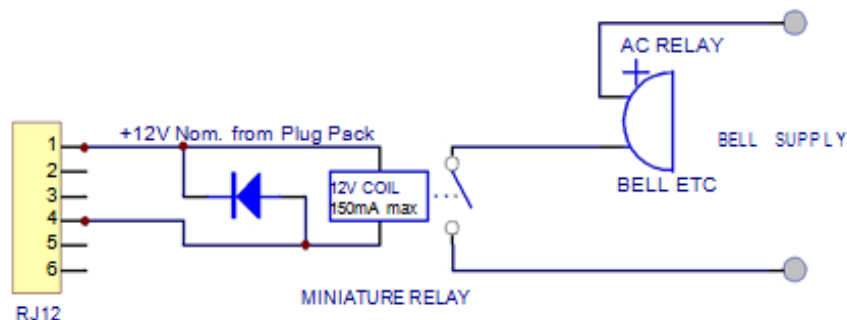

**NOTE:** Failure to insert a circuit protection diode will result in damage to the monitor if a voltage spike is created by the relay.

## 6.2 Wiring for Control

The control pin can be wired to supply control of a gas concentration between upper and lower concentration limits. The upper and lower limits can be set by the user. The factory default settings are dependent on the gas sensor head selected at time of purchase.

- To switch to GND, wire to pins 3 and 6
- To switch to 12V output, wire to pins 3 and 1

**NOTE:** Wiring for control will only operate while the Series 500 is powered by the AC adaptor.

Control is achieved by using a software latch. If power is lost to the monitor, the switch will open and therefore turn off the external device connected to the monitor external output. The following wiring diagram demonstrates the typical wiring to achieve the required control.

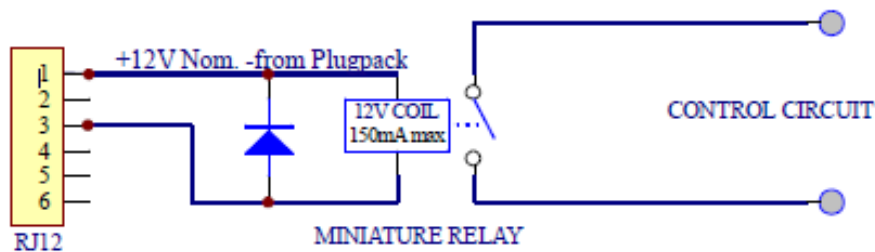

**NOTE:** Failure to insert a circuit protection diode will result in damage to the monitor if a voltage spike is created by the relay.

## 6.3 Wiring the 0-5 V Analogue Output

The 0 to 5 V signal is a proportional signal based on the measurement of the selected output sensor. The voltage out spans the specified gas sensor concentration range. For example: With the low concentration ozone sensor head: 0 V represents 0 ppm ozone and 5 V represents 0.500 ppm ozone. The ultra-low ozone sensor is a special case – 1.5V represents 0.150ppm ozone in this case.

- Wire between pins 2 and 6

## 7 Calibration

Aeroqual gas and particulate sensor heads can be calibrated in two ways:

1. **Factory calibration** – Gas and particulate matter (PM) sensors  
Return sensors to Aeroqual for a multi-point calibration and new calibration certificate  
Contact [technical@aeroqual.com](mailto:technical@aeroqual.com)
2. **Manual calibration** – Gas sensors only  
Follow the calibration steps in the following sub-sections

In order to calibrate successfully the following equipment is required:

- R42 Calibration Accessory (available from Aeroqual)
- Inert tubing (Regulator to gas inlet) See table for gas/material compatibility
- 0.5 LPM constant flow regulator (e.g. Calgaz regulator model 715, flow rate 0.5 LPM)
- Span gas in air cylinder
- Zero grade air cylinder

### 7.1 Calibration FAQ's

#### **What do I Calibrate, the monitor or the sensor head?**

Aeroqual's unique system of interchangeable sensor heads means they can be calibrated independently of the monitor. If you are sending a sensor head to us for factory calibration, then you do not need to send the monitor back. The monitor base does not need to be calibrated. Note: the Series 300 and 500 monitor bases can be used to calibrate the zero and span of any sensor head (including those from one of our fixed monitors); the Series 200 base can only be used for a zero calibration.

#### **How do I know my Sensor Head is reading accurately?**

All our sensor heads come with a factory calibration certificate. Over time the sensor head will need to be re-calibrated to ensure it is reading accurately. See below for a full discussion of how and when to re-calibrate. In between calibrations, particularly when the monitor is being used for health and safety purposes, a bump test is used to check the sensor is responding.

#### **How do I do a bump test?**

A bump test typically involves brief exposure of the sensor to a known quantity of gas and making sure the monitor reading corresponds with that concentration. Unlike calibration there is no adjustment of the monitor in response to the level of gas detected. For instructions on how to bump test your handheld monitor refer to Section 7.4.

#### **What is the difference between a zero and span calibration?**

Zero calibration involves delivering a certified clean air (sometimes called zero air) source to the sensor head and monitoring the response. If a non-zero reading is given, an adjustment is made so that the monitor reports zero concentration.

A span calibration involves delivering certified calibration gas of a known concentration to the monitor and monitoring the response to that concentration. An example might be delivering 10 ppm of Carbon



Monoxide (CO) to the CO monitor. The response of the monitor to the calibration gas is adjusted so that the monitor reads exactly the concentration of the span gas being delivered.

For instructions on how to zero and span calibrate your handheld monitor refer to Sections 7.5 and 7.6 respectively.

### **What is the difference between field and factory calibration?**

As the name suggests factory calibration means calibration by the manufacturer or suitably qualified laboratory. Field calibration involves calibration of the sensor head by the end user.

### **How do I calibrate my ozone sensor head in the field?**

There is an important difference between ozone and other types of gases. Ozone cannot be stored in bottles. Instead ozone must be generated at source using an ozone generator. A zero calibration can be done using a zero air bottle, but for a span calibration you must be able to generate ozone. If you have an ozone generator/calibrator then instructions on field calibration can be found in Section 7.6. If you do not have an ozone generator/calibrator then we recommend sending the ozone sensors for factory calibration (see below). Note: this applies for our PERC sensor heads too, because PERC is only available as a solvent.

### **How do I calibrate my non-ozone sensor head in the field?**

For non-ozone sensors, instructions on field calibration using calibration gas can be found in Section 7.6. watch a video demonstration of a gas sensor head calibration here: <https://vimeo.com/76908258>

### **How often do I need to field calibrate my sensor head?**

This depends on the level of rigor required in your measurement application. Researchers may calibrate before every measurement they take. But for most people regular calibration is enough to ensure good results. By regular we mean once or twice per year. For the reasons of cost and complexity outlined above, customers tend to calibrate ozone sensor heads less often and instead send them to the manufacturer or laboratory once every year or so.

### **How do I factory calibrate my sensor head?**

Simply send the sensor head to us or a suitably qualified laboratory. Our charges for factory calibration are quite reasonable. Please [contact us](#) for a quotation.

### **How often do I have to factory calibrate my sensor head?**

If you're able to field calibrate your sensor head you may never need to send it to us for calibration. However if you want to be 100% sure of the calibration, an annual factory calibration complete with certificate provides ultimate peace of mind. Ozone sensors are hard to calibrate in the field so we recommend sending for factory calibration once every year.

### **What is the expected lifetime of my sensor head?**

This is hard to answer as it depends on the type of sensor and the application it used in. As a guide assume your sensor will last two years, however higher exposure levels or harsh environments can

lead to a significant reduction in life expectancy. Your monitor display is likely to indicate “Sensor Failure” or “Sensor Ageing” if the sensor is nearing the end of its useful life.

## 7.2 Calibration Certificate

The date the sensor head calibration was completed.

The Serial Number is used to identify the sensor head. It should be quoted on all technical enquires relating to the specific sensor.

These are the temperature and relative humidity readings of the lab during calibration of the sensor head.



Aeroqual Limited  
480 Rosebank Road, Avondale, Auckland 1026, New Zealand.  
Phone: +64-9-623 3013 Fax: +64-9-623 3012  
www.aeroqual.com

**Calibration Certificate No. 20748**

---

**Calibration Date:** 30 Oct 2017 10:20

---

**Model:** Ozone Ultra Low 0-0.15 ppm

---

**Serial No:** OZUL1612200-889

---

**Environmental Conditions**

Temperature  °C

Relative Humidity  %

---

**Measurements**

Calibration Standard /ppm	0.005	0.066	0.119	0.000
AQL Sensor (Mean) /ppm	0.005	0.065	0.119	0.000
AQL Sensor (Std. Dev) /ppm	0.000	0.001	0.000	0.000

\*The Mean and Standard Deviation are calculated from three consecutive readings.

---

**Calibration Standard**

The Aeroqual ozone sensors are calibrated in a controlled environment against a NATA certified ozone UV photometer whose traceability is maintained with international standards organisations. \*NATA is Australia's national body for accreditation of producers of certified reference materials.

---

**QC Approval:**

**Date:**

The “Calibration Standard” shows the analyser concentration (span point) that the sensor was exposed to in ppm.

The “AQL Sensor (Mean)” shows the average of three readings on the sensor head, in ppm, at each span point.

The “AQL sensor (Std.Dev)” shows the standard deviation (variation) of three readings on the sensor head, in ppm, at each span point.

Signature of calibration engineer and date of signing. (The date may not necessarily be the same as the date of calibration)

## 7.3 Calibration Accessory

Aeroqual’s Calibration Accessory (P/N R42) facilitates humidity control and delivery of calibration gas to the sensor head. Follow the steps below to prepare the Calibration Accessory for zero or span calibration of a sensor head.

1. Fill R42 Calibration Gas Accessory with 5g of water with water syringe via water inlet.
2. Connect cylinder and regulator to R42 gas inlet via tubing and Luer attachment.
3. Insert warmed up sensor head (mesh cover end) into the outlet of the R42 as shown below.



**NOTE:** The R42 cannot be used for the calibration of NH3 and PERC, these sensors need to be returned to Aeroqual for calibration.

Watch a video demonstration of a gas sensor head calibration here: <https://vimeo.com/76908258>

## 7.4 Bump Test

Operators may wish to have increased confidence in the operation of their monitor by performing a bump test prior to taking measurements.

A bump test involves quickly exposing the sensor to span gas and confirming the sensor indicates an elevated response. The equipment for performing a bump test is the same as for performing a span calibration, however it is not necessary to wait for the monitor to warm up before performing a bump test, nor is it necessary to wait for the monitor readings to stabilize to confirm a successful bump test.

Turn on the monitor and place it at the outlet of the R42, you will need to wait three minutes before readings will be displayed on the monitor. Turn on the span gas and observe the sensor reading, the reading should quickly elevate above the baseline reading and approach that of the span gas concentration. If the reading does not approach that of the span concentration this could indicate a monitor fault or the need to perform a calibration. Once an elevated reading has been observed close to the span gas concentration the gas can be turned off, you must then wait for the readings to come down to baseline level before taking measurements.

## 7.5 Zero Calibration



Under some circumstances, sensors may temporarily exhibit a baseline reading higher than zero due to insufficient warm-up, or cross-sensitivity to other gases. In this case it is worthwhile checking against a standard zero air source.







### 7.5.1 Zero Calibration Procedure

Follow the initial set up instructions in Section 7.3, then proceed as follows:

- Flow zero air until the reading stabilises (about 10 minutes)
- Initiate **ZERO CAL** on the monitor, see Section 4.2.1:

**Series 200:** Press and hold  until the word **ZEROING** appears next to **ZERO CAL**. The routine will run for up to ten minutes (depending on the gas sensor installed) and then beep to indicate completion.

**Series 300 and 500:** Enter the **CALIBRATE** menu by pressing the  and  buttons for 2 seconds, then select **ZERO CAL** then:

- **Single gas heads:** Toggle YES/NO using the   buttons, select YES then press . The word **ZEROING** appears, the zero routine will run for up to ten minutes (depending on the gas sensor installed) and then beep to indicate completion.
- **PM sensor head and T/RH probe:** Press  to bring up the OFFSET for the sensor head. Use the   buttons to change the OFFSET and press  to accept. Calculate the new OFFSET using the equation below:

$$\text{New OFFSET} = (\text{Sensor Reading}/\text{GAIN}) + \text{Old OFFSET}$$

**NOTE:** Offsets are stored on the sensor, Temp/RH offsets are stored on the monitor.

## 7.6 Span Calibration (Series 300 and 500)

Span calibration provides an option to adjust the GAIN of Aeroqual sensor heads.

There are no optimum span concentrations for calibrating Aeroqual sensor heads. There are however a few considerations which can guide the decision as to which span concentration is most appropriate.

For the majority of uses, gases will be purchased for calibration at the concentration to be used for the span calibration, rather than purchased at high concentrations and diluted using a gas dilution calibrator. Therefore users may find some restrictions on what concentrations can be provided by their chosen calibration gas supplier.

For some applications measurements will be made close to the monitor's maximum detection limit. For these applications a span point at 80 % of full scale is suggested. For other applications, gas levels may be important across a broad range rather than just close to the maximum exposure limit. Other applications may make more use of the lower end of the sensors working range, with higher levels occurring less frequently and having less importance. The most appropriate span point will thus depend upon the intended application. If the intended application is not known, Aeroqual suggests a span point at 80 % of full scale. All gases should be purchased in a balance of air.



Aeroqual Sensor Head	Suggested span point 80 % Full Scale (in a balance of air)	Tubing material for gas calibration
Carbon Monoxide 0-25 ppm	20	Tygon R-3606
Carbon Monoxide 0-100 ppm	80	Tygon R-3606
Carbon Monoxide 0-1000 ppm (leak)	800	Tygon R-3606
Carbon Dioxide 0-2000 ppm	1600	Tygon R-3606
Carbon Dioxide 0-5000 ppm	4000	Tygon R-3606
Nitrogen Dioxide 0-1 ppm	0.8	PTFE (Teflon)
NH3 0-100ppm	Factory calibration required	-
NH3 0-1000ppm (leak)	Factory calibration required	-
Hydrogen 0-5000 ppm	4000	PTFE (Teflon)
H <sub>2</sub> S 0-10 ppm	8	PTFE (Teflon)
H <sub>2</sub> S 0-100 ppm	80	PTFE (Teflon)
Methane 0-10000 ppm	8000	PTFE (Teflon)
Ozone (OZU) 0-0.15 ppm	0.12	PTFE (Teflon)
Ozone (OZL) 0-0.5 ppm	0.4	PTFE (Teflon)
Ozone (OZG) 0-10 ppm	8	PTFE (Teflon)
PERC 0-200 ppm	Factory calibration required	-
SO <sub>2</sub> 0-10 ppm	8	PTFE (Teflon)
SO <sub>2</sub> 0-100 ppm	80	PTFE (Teflon)
VOC (Isobutylene) 0-25 ppm	20	PTFE (Teflon)
VOC (Isobutylene) 0-500 ppm	400	PTFE (Teflon)
NMHC (Isobutylene) 0-25 ppm	20	PTFE (Teflon)
PID (Isobutylene) 0-20	16	PTFE (Teflon)
PID (Isobutylene) 0-1000	800	PTFE (Teflon)

## 7.6.1 Span Calibration Procedure

### ▲ IMPORTANT

- Always point the cylinder and regulator away from yourself and others when attaching or removing a pressure regulator.
- Always secure the cylinder to prevent it from being knocked over while the regulator is attached.

Follow the initial set up instructions in Section 7.3, then proceed as follows:

- Flow the target gas at 0.5 LPM
- Measure the gas concentration on the monitor screen and wait for it to stabilise (10 minutes).
- If the Aeroqual sensor head requires a span adjustment then enter the **CALIBRATE** menu by pressing the  and  buttons simultaneously for 2 seconds. Then select **SPAN CAL** and change the GAIN using the scroll buttons. Calculate the new GAIN using the equation below:

$$\text{New GAIN} = \text{Old GAIN} \times (\text{Span Gas Concentration (ppm)} / \text{Sensor Reading})$$

**NOTE:** Temp/RH GAIN are stored on the handheld not on the sensor. Other GAIN are stored on the sensor.

## 7.7 Health and safety during calibration

Upmost care must be taken while performing a zero or span calibration. Cylinder gas can cause harm in a number of ways. There a number of sources of good information about the correct use and storage of compressed gases.

The following resources may prove useful:

- The National Institute for Occupational Safety and Health:  
<http://www.cdc.gov/NIOSH/>
- The United States Department of Labour  
<http://www.osha.gov/SLTC/compressedgasequipment/index.html>

The following information is a guide for what to consider when handling compressed gas but Aeroqual recommends operators adhere to their local regulations regarding compressed gas handling.

### 7.7.1 High pressure leak or failure of pressure regulator

Many calibration gases are held in cylinders at high pressure in excess of 1000 Psi. Incorrectly fitting the pressure regulator, using a regulator which is faulty or knocking the cylinder over while the regulator is attached can cause physical harm from high speed projectiles resulting from a high pressure leak from or failure of the regulator.

It is important to always fit a high quality undamaged pressure regulator to the gas cylinder and that the regulator type is suitable for the cylinder you are attaching it to.

Always use protective eyewear (safety glasses) when working with compressed gas.

### 7.7.2 Flammability of combustible gases

Calibration gas can be stored in cylinders at high concentrations and can this can present a hazard if those gases are combustible. The lower explosive limit (**LEL**) is the lowest concentration of gas at which combustion will be sustained in air if an ignition source (spark or flame) is present. The LELs for the gases used for calibrating Aeroqual sensor heads are all significantly above the calibration span points so this risk is low. It is important however that the LEL be known for the gas being employed and that suitable precautions be taken to further minimize the risk from explosive combustion such as performing the calibration in a fume hood. The table below lists the LELs for the gases used to calibrate Aeroqual's sensor heads.

### 7.7.3 Toxicity

While most of the recommend span points fall below the Immediately Dangerous to Life or Health (IDLH) limits published by the National Institute for Occupational Health and Safety (NIOSH), some span points are **above** these limits and therefore it is crucial that rigorous health and safety procedures be followed during calibration to avoid exposure to the calibration gas.

IDLH concentration limits as well as concentration limits for longer exposure times are listed in Section 7.7.4

The LDLH limits are known for most of the gases of concern, however there are some gases for which data are not available. In these cases gases should be considered as being toxic and handled as such. Health and safety data are often revised, Aeroqual recommends checking external sources for the most up to date information. Aeroqual suggests that all span calibrations be performed in a fume hood such as the one in the image below to avoid exposure to personal.



#### 7.7.4 IDLH Concentration Limits

##### ▲ IMPORTANT

- The information below is provided as an indication only. Please check for the latest information or local guidelines as values may vary by jurisdiction.
- Always use protective eyewear (safety glasses) when working with compressed gas.

Gas	IDLH (ppm)	PEL (ppm)	STEL (ppm)	LEL (ppm)
Carbon Monoxide	1200	25	N/A	125,000
Carbon Dioxide	40000	5000	30000	N/A
Nitrogen Dioxide	20	N/A	1	N/A
Ammonia	300	25	35	150,000
Hydrogen	N/A	N/A	N/A	40,000
Hydrogen Sulfide	100	10	15	40,000
Methane	N/A	N/A	N/A	50,000
Ozone	5	0.1	0.3	N/A
PERC	150	N/A	N/A	N/A
Sulphur Dioxide	100	2	5	N/A
Isobutylene	N/A	N/A	N/A	18,000

IDLH Immediately Dangerous to Life or Health

PEL Permissible exposure limit (usually based upon a time weighted 8 hour average)

STEL Short - term exposure limit (1 hour average)

LEL Lower explosion limit

Source: <http://www.cdc.gov/niosh/idlh/intridl4.html>

## 8 Specifications

The Aeroqual handheld monitors have been specifically designed to incorporate Aeroqual's in-depth knowledge of accurate ambient gas measurement and can be used with a wide range of gas sensor heads. The sensor heads are interchangeable and therefore multiple heads can be used on the same base unit. The sensors are calibrated prior to delivery.

<b>Gas measurement units</b>	ppm or mg/m3
<b>Reading functions</b>	Minimum, maximum, average
<b>Sensor head</b>	Interchangeable, replaceable
<b>Display type</b>	LCD
<b>Display status indicators</b>	Battery, sensor, standby, mute, high/low alarm, monitor ID, location ID.
<b>Sensor calibration features (S300 S500)</b>	Zero and span via secret menu
<b>Power supply</b>	12V DC (power adaptor/charger supplied 100-250V AC)
<b>Rechargeable battery</b>	Ni-MH 9.6V DC   2100mA/h or Lithium 11.1V
<b>Temperature &amp; Humidity sensor</b>	Temp: -40°C to 124°C; RH: 0 to 100%
<b>Size (with sensor head)</b>	195 x 122 x 54 (mm)
<b>Weight (with sensor head and battery)</b>	< 460 g
<b>Environmental operating conditions</b>	Temperature: -5 °C to 45 °C Humidity: 0 to 95% non-condensing
<b>Enclosure material and rating</b>	PC and ABS; IP20 and NEMA 1 equivalent
<b>Audible Alarm (S300 &amp; S500)</b>	Low alarm, high alarm
<b>External transistor outputs for alarms &amp; control (S300 &amp; S500)*</b>	12 VDC or switch to GND (150 mA max)
<b>Analogue output (S300 &amp; S500)</b>	0-5V
<b>Digital interface (S500)</b>	RS232 with USB converter
<b>Data logging capacity (S500)</b>	8188 data points in total
<b>PC data logging (S500)</b>	Software and data cable supplied
<b>Clock function (S500)</b>	Real time
<b>Approvals</b>	Part 15 of FCC Rules EN 50082-1: 1997 EN 50081-1: 1992



\*All of the transistor outputs are open collector current sink. The maximum rating of these transistor outputs is 12VDC at 150mA. If you connect a relay or any other inductive load to the transistor outputs, a back EMF suppression diode must be fitted across the load.

Aeroqual accepts no responsibility for damage to this product or any other issues arising from the non-compliance with the above directives. Failure to implement these directives will invalidate the warranty on this product.



## 8.1 Dimensions

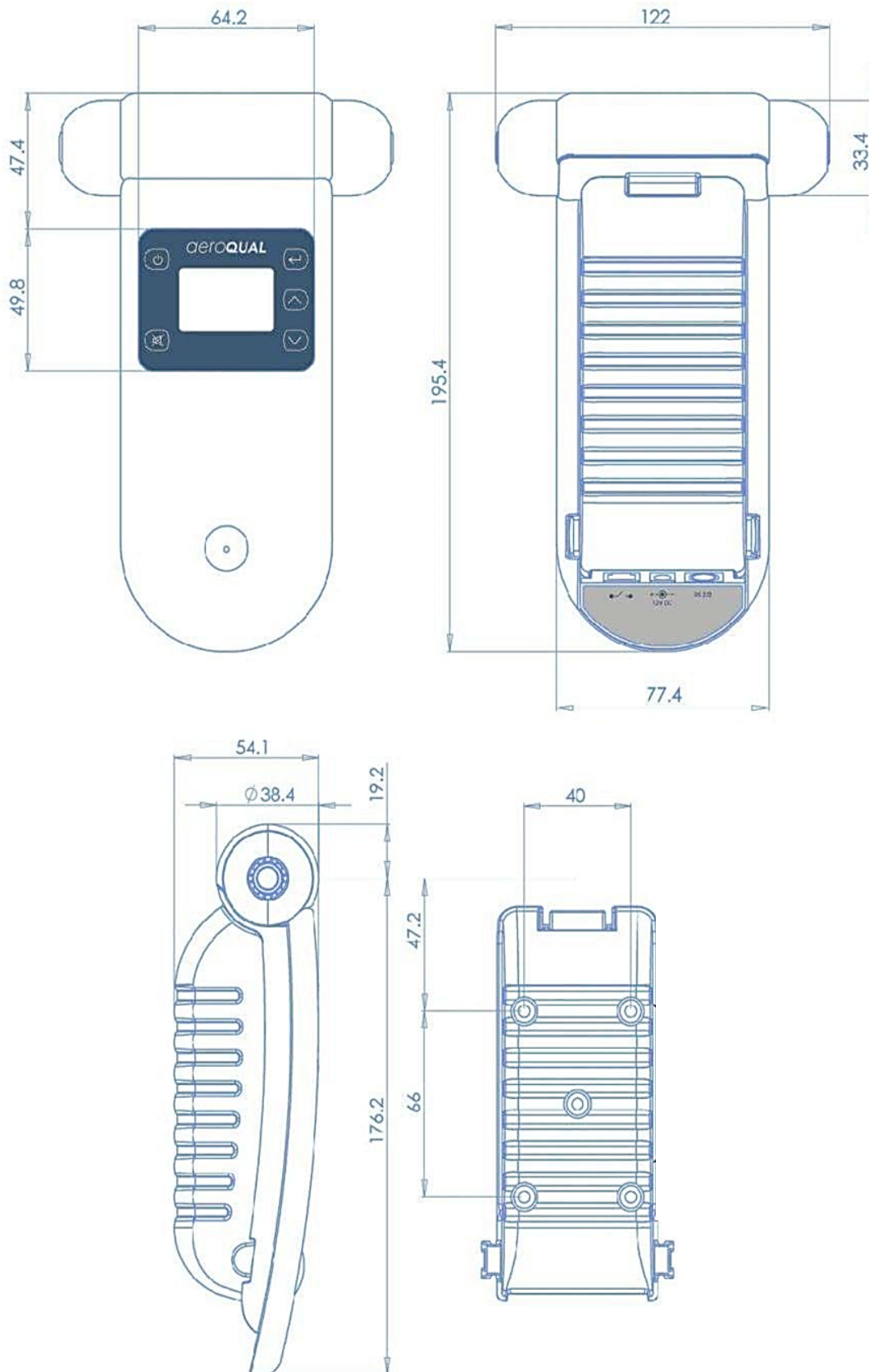

## 9 Optional Accessories:

### 9.1 Temperature and Relative Humidity Sensor (HH TRH)

If the temperature and relative humidity sensor has been purchased, it can be inserted into the PS/2 connector at the base of the monitor. Ensure monitor is turned off before connecting the sensor.

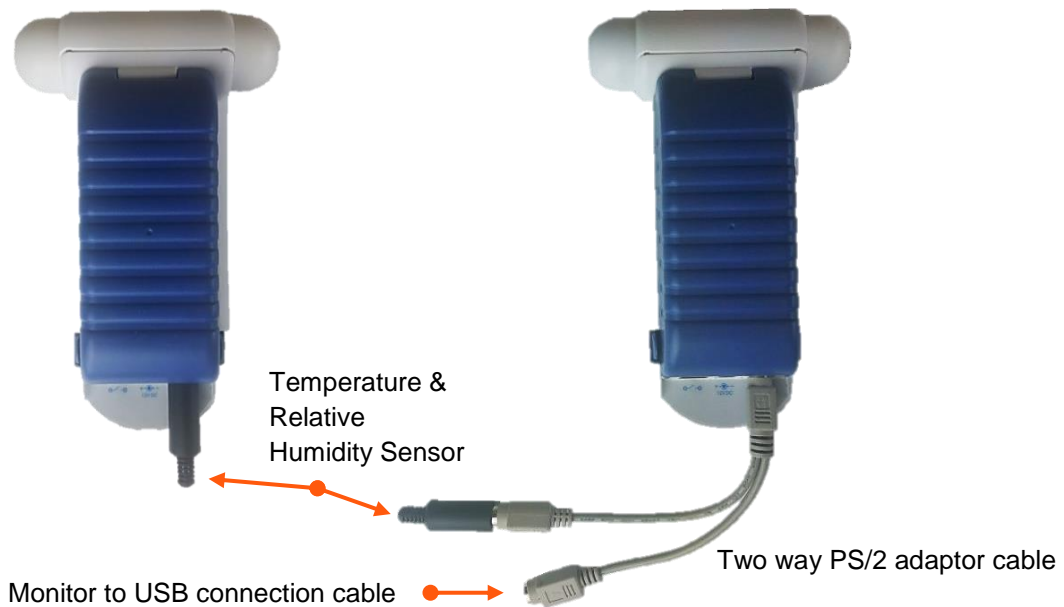

**NOTE:** The monitor will still operate with only the temperature and RH sensor connected.

### 9.2 Handheld Enclosure (HH ENC)

The handheld FRP enclosure is designed for fixed or secure monitoring. The inlet nozzles are specifically designed to eliminate dust and reduce water ingress whilst minimising destruction of part per billion gas concentrations or measurement variations due to outgas contamination from the enclosure.

**NOTE:** Sensor heads fitted to this product must be Type 2 sensor heads that have fitted connectors and are specifically calibrated to factor in the longer flow path. See sensor head variants in Section 3.2

Dimensions	Value
Height (including cable gland)	283 mm
Width	180 mm
Depth	90 mm
Materials	Fibre-glass reinforced polycarbonate base
	Polycarbonate lid
Mounting	Screw fixture
Operating temperature	-35°C to 120°C

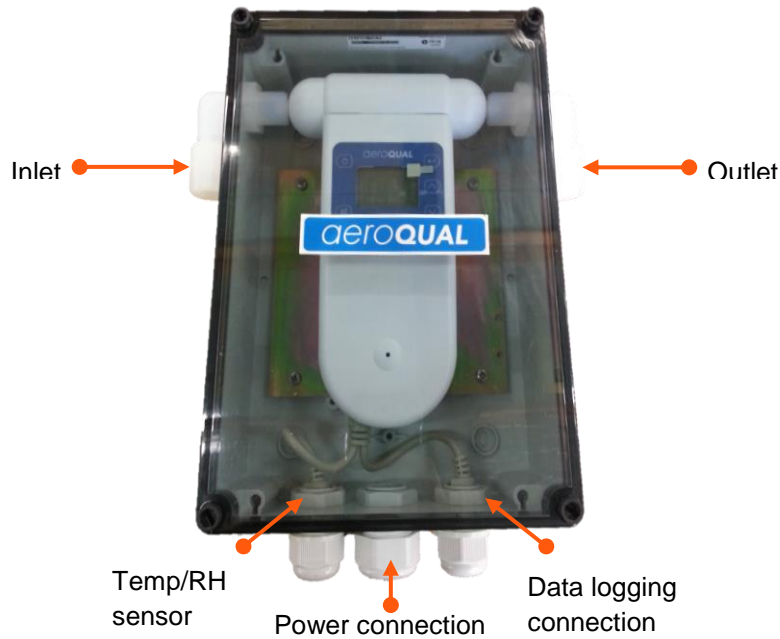

### 9.2.1 Replacing the Sensor Head

- Using a flat headed screw driver undo the four lid screws at each corner and remove the lid
- Undo the lock nuts on either end and remove the inlet and outlet nozzles and remove the sensor head by carefully pulling it upwards, disconnecting it from the monitor
- Replace the sensor head with another Type 2 sensor – see Section 3.2
- Re-insert the nozzles and tighten using the lock-nuts, ensure there is a tight fit against the sensor head
- Replace the lid and tighten the four lid screws



### 9.2.2 Removing the Monitor

- Undo the four lid screws at each corner using a flat headed screw driver and remove the lid
- Loosen the lock nuts (see image above) on either end of the sensor head and disconnect the inlet and outlet elbows from the sensor head
- Disconnect connections at the bottom of the monitor: power, temp/RH sensor, data logging
- Push in the blue plastic clips on either side of the monitor unit to release the monitor
- Carefully remove the monitor and sensor from the enclosure
- Reverse the process to reconnect the monitor back onto the battery cover



### 9.3 Remote Sensor Head Adaptors (AS R10 / AS R13)

The AS R10 and AS R13 are designed for remote monitoring away from the monitor base. They are both compatible with the portable monitor (Series 200/300/500) and fixed monitor (Series 900/930) range of instruments.

The AS R10 is the basic option with 2 m of CAT5 cable, the AS R13 is an IP41 rated option providing additional protection to compatible sensor heads, and comes with 10 m of CAT5 cable.

**NOTE:** Up to 14m of CAT cable can be used for connection.

#### 9.3.1 Connecting the IP20 / NEMA 1 Remote Sensor Head Adaptor (AS R10)

The AS R10 comes with a circular base, a sensor adaptor and 2 m CAT5 cable.

- Connect the sensor adaptor into the portable or fixed monitor base
- Connect the gas sensor head into the circular base
- Plug each end of the CAT5 cable into the circular base and sensor adaptor
- The monitor base can now be turned on and measurements taken



#### 9.3.2 Connecting the IP41 / NEMA 2 Remote Sensor Head Adaptor (AS R13)

The AS R13 comes with an IP41 rated enclosure, a sensor adaptor and 10 m of CAT5 cable

- Connect the sensor adaptor into the portable or fixed monitor base
- Connect the gas sensor head inside the IP41 rated enclosure. Ensure the nozzles are tightly secured on the inlet and outlet of the sensor head
- Plug each end of the CAT5 cable into the IP41 rated enclosure and the sensor adaptor.
- Ensure the cable gland on the IP41 is tightened securely
- The monitor base can now be turned on and measurements taken



**NOTE:** The IP41 rated enclosure is only compatible with the Type 2 sensor heads – see Section 3.2.

## 10 Troubleshooting

Fault Description	Possible cause	Remedy
No power	Lead connection broken Power supply failure Battery flat Unit damaged Sensor head damaged	Reconnect power lead Replace 12V DC power supply Recharge battery Replace unit Replace sensor head
Sensor failure when the sensor is new	Insufficient warm-up Air contaminated Sensor damaged	Run the sensor on full power for 24-48 hours. If using an ozone sensor head and an O3 source is available, exposure to 100 ppb for 5 minutes will speed up the decontamination process (approximately 30 minutes) Move the sensor to cleaner environment and check reading Replace sensor
Reading high under zero gas conditions	Background gas level higher than normal Interfering gas present Sensor zero drift Sensor damaged	Move sensor to clean air and check reading is zero or close to zero Move sensor to clean air and check reading is zero or close to zero ZERO CAL sensor zero grade air using R42 Replace sensor
Reading higher than expected in the presence of sensor gas	Sensor correct Interfering gas present Sensor calibration lost	Check calibration of gas generator. Move sensor to clean air and check reading upon exposure to known gas concentration Replace /refurbish sensor
Reading lower than expected reading in the presence of sensor gas	Sensor correct Sensor inlet contaminated Sensor fan failed	Check calibration of gas generator Clean sensor inlet filter and mesh Replace sensor

Fault Description	Possible cause	Remedy
	<p>Interfering gas present</p> <p>Gas reactive and decomposing before detection</p> <p>Local air flow too high (ozone sensors) or too low (VOC and ammonia sensors)</p> <p>Sensor calibration lost</p>	<p>Move sensor to clean air and check reading upon exposure to known gas concentration</p> <p>Move the monitor closer to the source of the gas</p> <p>Modify the airflow into and around sensor head.</p> <p>Replace /refurbish sensor</p>
Reading unstable	<p>Power supply unstable</p> <p>Power supply current rating incorrect</p> <p>Local air flow too high</p> <p>Environmental conditions fluctuating</p> <p>EMI noise picked up via USB cable and PC (S500 unit only)</p>	<p>Install stable power supply</p> <p>Install power supply with correct rating</p> <p>Reduce air flow</p> <p>Reduce fluctuations</p> <p>Unplug cable to determine if this reduces the instability. If this solves the problem then isolate the power on PC</p>
External alarm and control doesn't work correctly (Series 300 and 500 units only)	<p>Incorrect RJ12 pins used</p> <p>No diode across external relay coil</p> <p>Diode polarity incorrect</p>	<p>Check pins and wire correctly</p> <p>Fit diode across external relay coil</p> <p>Fit diode correctly</p>
USB communications unstable (S500 only)	<p>Connections broken</p> <p>COM Port settings incorrect</p> <p>Clock setting incorrect</p>	<p>Reconnect leads</p> <p>Setup COM port correctly</p> <p>Synchronise clock with PC. If this does not work then the Monitor clock battery may be flat. Return monitor to Aeroqual for battery replacement.</p>

If after troubleshooting you are unable to resolve the problem, contact [technical@aeroqual.com](mailto:technical@aeroqual.com).

Please ensure serial numbers of the base and/or affected sensor/s are included in your email.

## 10.1 Sensor Failure

The handheld monitors have inbuilt diagnostics to detect sensor faults. If the sensor fails it can be easily replaced by simply removing and installing a new one. The failed sensor can be sent back to Aeroqual for refurbishment or disposal. Monitor status conditions are as follows:

Fault Description	LCD Screen	0-5V Output (S300 & S500 only)	Control Output (S300 & S500 only)	Low Alarm Output (S300 & S500 only)	High Alarm Output (S300 & S500 only)	Data Logging (S500 only)
No Fault	Valid gas reading	Reading proportional to gas reading	As set by user	As set by user	As set by user	Valid gas reading
Sensor Failed Fault	Sensor failure	5 V	Open	Closed	Closed	9999
Sensor Aging Fault	Valid gas reading + sensor aging	Reading proportional to gas reading	As set by user	As set by user	As set by user	Valid gas reading
Communications Failure	SENSOR NOT CONNECTED or N.C. or turn off when use Ni-MH battery only	0 V	Open	Open	Open	No output
Sensor Standby	Standby symbol	0 V	Open	Open	Open	No output

## 11 Technical Support

Technical information, service and spare parts are available through your distributor. In addition, worldwide technical support is available from Aeroqual Ltd.

### Aeroqual Limited

460 Rosebank Road, Avondale, Auckland 1026, New Zealand

Phone: +64 9 623 3013

Fax: +64 9 623 3012

Email: [technical@aeroqual.com](mailto:technical@aeroqual.com)

## 12 Care and Maintenance

Your Aeroqual Monitor is a product of superior design and quality and should be treated with care.

When using your Aeroqual Monitor:

- Keep it and all its parts and accessories out of the reach of small children.
- Keep it dry. Avoid water and/or condensation as humidity and liquids may damage sensitive electronics and the Li battery.
- Do not use or store in dusty, dirty areas.
- Do not store the monitor in temperatures below 10°C or above 35°C.
- This unit is designed for use at temperatures between -5°C and +45°C however please consult recommended operating temperature for the sensor head which may be different. Avoid sudden changes in temperature which may cause condensation that can damage the electronics.
- Do not attempt to open. Non-expert handling of the device may cause damage.
- Do not drop, knock or shake as this could lead to internal damage.
- Do not use harsh chemicals, cleaning solvents or strong detergents for cleaning. Wipe with a soft cloth slightly dampened with a mild soap-and-water solution

**In order to maintain measurement accuracy, Aeroqual recommends that users replace or refurbish their sensor heads on a yearly basis or more often if measurement certainty is critical for your application. Please contact your dealer or Aeroqual.**

### 12.1 Disposal / Recycling

Please note that this is an electronic product and disposal should be in line with your local or country legislation. The plastic casing of the product is made from a Polycarbonate / ABS blended material (PC + ABS) and is marked accordingly.



## 13 Appendix

### 13.1 General Guidelines on the Measurement of Gases

A key factor in reliable leak detection is to locate the sensor between the potential leak source and the ignition site or location of people. Sensors do not detect in a dispersive manner. They rely on single point monitoring. The leak must reach this single monitoring point, in order to be detected. This is precisely the reason why the sensor location and number of sensor installed is of utmost importance.

#### Sensor height

Mount the sensor at the appropriate height for the density of gas you wish to detect.

Heavier than air*	Near the ground <i>No lower than 457 mm (18 inches), and in some cases, no higher than 914 mm (36 inches)</i>
Lighter than air*	Near ceiling, roof or out-take fan

\*Air currents often result in inconsistent air circulation. Always be aware of areas that could facilitate irregular air currents and abnormal build-ups of gas (*gas pockets*).

#### Gas and vapour dispersion

Sensor installation should be near the potential leak source. Readings take longer to register with slow dispersion liquids if the sensor is installed too far from the leak source.

#### Temperature limitations

Ambient temperature can greatly affect the sensor's performance. Whether too hot or too cold, make sure all sensors and electronics are operating within their ambient temperature limitations.

#### Vibration

Be sure to anchor any sensor installation to a firm base. Securing the sensor to a vibration source compromises the life of the sensor and may void the sensor's warranty.

#### Moisture

Unless installed with moisture protection accessories, sensors should be mounted away from moisture sources. When exposed to excessive moisture or direct water spray, sensors may fail, or experience shortened life span.

#### Sensor orientation

Ensure the sensor to be installed is not sensitive to or dependent upon its mounting orientation in order to operate effectively.

#### Dust and dirt

Mount sensors away from areas prone to dust and dirt. If not feasible, make sure the optional dust protection accessories are fitted.

## 13.2 Specific Guidelines on the Measurement of Ozone

### ▲ IMPORTANT

- Smell is not a reliable test for detecting the presence or concentration of ozone as the odour threshold varies widely between people and is affected by local ambient conditions.

The following information is to help users operate their Aeroqual monitor with an ozone sensor.

#### Sensor height

Ozone is heavier than air and tends to sink, concentration gradients are common in rooms and are greatly influenced by air movement and mixing. Thus detection of leaks from ozone generating equipment should be performed at the most appropriate position for the application.

#### Gas and vapour dispersion

Ozone is highly reactive and will rapidly react and decompose on organic surfaces such as walls, flooring, furniture, plastic test chambers, people etc. The greater the accuracy of the ozone monitor, the greater the variation in ozone concentration measured

High accuracy ozone monitors will detect differences in ozone concentrations and variations with time. Use monitors with Min/Max/Average measurement cycles to reduce the effect of these fluctuations.

If you are testing the accuracy of ozone monitors in test chambers, ensure the chamber and devices inside the chamber are clean and non-reactive, e.g. glass or a fluoropolymer.

#### Monitor placement

The Aeroqual ozone sensor has been designed to measure the ambient concentration of ozone and must not be placed directly in an ozone stream. Do not use dusty and dirty air inlets or filters as ozone will react with dust and oils and lower the measured ozone concentration.

- For indoor local area monitoring attach the monitor to an inert surface with the inlet unobstructed
- For leak detection mount the unit near the ozone generating equipment

Ensure that the monitor is protected from water splashing, dust, vibration, excessive heat or cold, high concentrations of ozone and excessive swings in humidity.

#### False Readings

The Aeroqual Ozone Controller has been designed to respond selectively to ozone. However, other oxidizing gases such as chlorine and nitrogen dioxide can generate false readings if they are at high concentrations. High concentrations of hydrocarbon gases such as vapours of alcohol, oils and solvents can reduce and mask the concentration of ozone.

## 13.3 Sensor Characteristics

### 13.3.1 Gas Sensitive Semiconductor (GSS) Sensor - Ozone

#### Cross-interferences

Aeroqual ozone sensors may exhibit a response to gases other than ozone. The magnitude of the response is a function of both the interference gas and its concentration. Typical sensor responses to some common gases are shown in the tables below (these are indicative responses and the actual response of a specific sensor may vary). A negative response means that the ozone sensor may under-read in the presence of that compound and this should be taken into account in ozone control applications.

Interfering gas	Sensor response ppm
Ammonia 25 ppm	-0.020
Butane 100 ppm	-0.005
Carbon monoxide 10 ppm	-0.005
Carbon dioxide 400 ppm	0.000
Chlorine 0.5 ppm	0.200
Ethanol 20 ppm	-0.020
Ethyl acetate 10 ppm	-0.020
Heptane 100 ppm	-0.005
Hydrogen sulfide 0.5 ppm	-0.100
Isopropanol 20 ppm	-0.010
Methane 100 ppm	0.000
Nitrogen dioxide 0.5 ppm	0.040
Ozone 0.1 ppm	0.100
Perchloroethylene 20 ppm	0.000
Propane 100 ppm	-0.005
Sulfur dioxide 1 ppm	-0.005
Toluene 20 ppm	-0.010

#### Environmental factors

Volatile Organic Compounds (VOCs) are sometimes present in applications and can produce cross-sensitive readings. The term "VOC" applies to a very wide range of hydrocarbons with different behaviours. At high concentrations of VOCs the sensor background compensation may become overwhelmed and the reading lower than actual. Users should also be aware that measurements of ozone in the presence of high concentrations of VOCs, particularly alkenes, may be lower than expected due to gas phase ozone reaction with the VOC.

The Aeroqual GSS ozone sensor will be poisoned by exposure to specific compounds such as silanes, silicones, phosphate esters and organochlorides. Silicones and silanes are present in many products such as lubricants, polishes, mold-release agents and adhesives and can permanently damage the sensor due to the formation of an impermeable glassy layer on the GSS sensor.

**Exposure to these compounds must be avoided.**

Cleaning processes in rooms fitted with Aeroqual ozone sensors should be carefully considered to ensure the process does not impact on the sensor accuracy. Cleaning systems that use mists or sprays may damage the sensor and the sensor should be powered down and removed or covered before cleaning starts.

Many applications require measurement and control of very low ozone concentrations below 200 parts per billion. At such low concentrations, you need to consider the following sampling issues to successfully measure and control ozone.

- **Ozone is highly reactive.** Ozone will rapidly react with organic compounds and surfaces such as walls, flooring, plastic testing chambers and people.
- **Ozone concentration gradients are common** in rooms and are greatly influenced by air movement and mixing. Concentrations may be lower near walls and surfaces or in areas with low air flow.

The ozone sensor head has a clean **stainless steel mesh** to filter out dusts. If this becomes dirty over time the sensor head will start to read incorrectly and will need to be replaced.

## Health and Safety

The Aeroqual GSS ozone sensor should be regularly tested and calibrated to ensure its correct operation. This is particularly important if used as part of a health and safety system.

### 13.4 Gas Sensitive Electrochemical (GSE) Sensor - Ozone

In response to requests for an ozone sensor with a wide range and fast speed of response, Aeroqual introduced an electrochemical ozone sensor head for use with handheld and fixed monitors.

The EOZ utilizes a Kalman filter to achieve a fast speed of response (4s update) with good accuracy across a wide range (0-10ppm). This makes it complementary to our gas sensitive semiconductor (GSS) sensors which offer unparalleled accuracy, sensitivity and stability at low ozone concentrations. The sensor has the following specifications:

Gas Sensor	Code	Sensor	Range (ppm)	Minimum Detection Limit (ppm)	Accuracy of Calibration	Operating Life	T90	Resolution (ppm)	Operational Range	
									Temp.	RH
Ozone (O3)	EOZ	GSE	0-10	0.01	<±(0.01 ppm + 7.5% of reading)	24 months	<60s	0.001	0 to 40°C	15 to 90%

#### Application

The EOZ sensor is less affected by VOC cross-interferences than the GSS sensors, but it is sensitive to NO2 and Cl2. Therefore the EOZ is best suited to indoor and industrial applications while less suited to ambient outdoor applications.

The high accuracy makes it a good choice for health and safety monitoring. The speed of response and wide range make it the sensible option for leak detection.

Applications include ozone generator control and/or leak detection in mechanical rooms, leak detection in laundry, industrial health and safety monitoring and many more.

**NOTE:** Where greater accuracy is required below 0.1 ppm, customers should use the GSS sensor head options – either OZL or OZU.

#### Operation

Unlike GSS sensors, electrochemical sensors do not have automatic baseline compensation which means they will have to be manually re-zeroed from time to time.

The required zero calibration frequency depends on the use of the instrument. If it is used to measure close to zero it will need to be zeroed more frequently than if used at higher concentrations.

There are two approaches to zero calibration – a high accuracy approach which does require zero air, and a more convenient re-zero in a low ozone environment (where known ozone level is <0.01ppm).

#### Operating Life

Electrochemical sensors start to degrade from the moment they are taken out of their protective packaging. This means that operating life begins from the date of manufacture. Electrochemical sensors will degrade even when on the shelf.

### Cross-Sensitivity

The EOZ sensor has the following cross-sensitivities:

H2S sensitivity	% measured gas @ 20ppm	H2S	< -40
NO2 sensitivity	% measured gas @ 10ppm	NO2	100
NO sensitivity	% measured gas @ 50ppm	NO	< 0.5
SO2 sensitivity	% measured gas @ 20ppm	SO2	< -2.5
CO sensitivity	% measured gas @ 400ppm	CO	< 0.1
H2 sensitivity	% measured gas @ 400ppm	H2	< 0.1
C2H4 sensitivity	% measured gas @ 400ppm	C2H4	< 0.1
Cl2 sensitivity	% measured gas @ 10ppm	Cl2	100

## 13.5 Gas Sensitive Electrochemical (GSE) Sensor - Other

### Sensor head cross interference information

The following information describes cross interferences for several of Aeroqual's sensor heads containing electrochemical sensor technology.

The tables describe the response of the sensor to different gases of different concentrations.

#### Nitrogen Dioxide Sensor (ENW)

Interference Gas	Concentration	Nitrogen Dioxide Sensor Reading (PPM)
Hydrogen Sulfide	1ppm	<-0.4
Chlorine	1ppm	1
Nitric Oxide	50ppm	<0.25
Sulfur Dioxide	20ppm	<-0.5
Carbon Monoxide	400ppm	<0.4
Hydrogen	400ppm	<0.4
Ethylene	50ppm	<0.05
Ammonia	20ppm	<0.02
Carbon Dioxide	1% volume	<0.001

#### Hydrogen Sulfide Sensor (EHS)

Interference Gas	Concentration	Hydrogen Sulfide Sensor Reading (ppm)
Nitrogen dioxide	10ppm	<-3
Chlorine	10ppm	<-2.5
Nitric Oxide	50ppm	<1
Sulfur Dioxide	20ppm	<2
Carbon Monoxide	400ppm	<6
Hydrogen	400ppm	<0.6
Ethylene	400ppm	<0.6
Ammonia	20ppm	<0.02

#### Sulfur Dioxide Sensor (ESO)

Interference Gas	Concentration	Sulfur Dioxide Sensor Reading (ppm)
Hydrogen Sulfide	20ppm	<0.02
Nitrogen dioxide	1ppm	<-1
Chlorine	10ppm	<-7
Nitric Oxide	50ppm	<2
Carbon Monoxide	1ppm	<0.04
Hydrogen	400ppm	<0.8
Ethylene	1ppm	<0.15
Ammonia	20ppm	<0.02

### Carbon Monoxide Sensor (ECM)

Interference Gas	Concentration	Carbon Monoxide Sensor Reading (ppm)
Nitrogen dioxide	10ppm	<0.01
Chlorine	10ppm	<0.01
Nitric Oxide	50ppm	<0.05
Sulfur Dioxide	20ppm	<0.02
Ethylene	1ppm	<0.3
Ammonia	20ppm	<0.02
Hydrogen	180ppm @ 10°C	<3.6
	180ppm @ 20°C	<7.2
	180ppm @ 30°C	<10.8

### Chlorine Sensor (ECL)

Interference Gas	Concentration	Chlorine Sensor Reading (ppm)
Hydrogen Sulfide	20ppm	<-8
Nitrogen dioxide	1ppm	1
Nitric Oxide	50ppm	<0.25
Sulfur Dioxide	20ppm	<-0.5
Carbon Monoxide	400ppm	<0.4
Ethylene	400ppm	<0.4
Hydrogen	400ppm	<0.4

### Ammonia Sensor (ENG)

Interference Gas	Concentration	Chlorine Sensor Reading (ppm)
Hydrogen Sulfide*	20ppm	1.4
Nitrogen dioxide*	20ppm	-4
Nitric Oxide*	20ppm	-0.2
Sulfur Dioxide*	20ppm	-1.4
Carbon Monoxide	300ppm	0
Chlorine	20ppm	-11
Carbon Dioxide	2%	0
Silane	10ppm	0
Hydrogen	200ppm	0

\*Long term exposure and high concentrations may affect the performance characteristics

### Formaldehyde Sensor (EF)

Interference Gas	Cross-Sensitivity (%)
Carbon Monoxide	10-18
Hydrogen	1-3
Interference from other reducing gases, such as alcohols	

### 13.6 Particulate Matter Sensor Head PM10 / PM2.5 sensor

Aeroqual’s PM Sensor Head offers precision active sampling, Fast T90response time, Humidity compensation, K factor adjustment (Series 300, 500 models) and is compatible with a wide range of gaseous measurements, providing the attention to data quality that Aeroqual is renowned for.

The Sensor has the following specifications:

PARTICULATE MATTER	SENSOR CODE	SENSOR TYPE	RANGE (mg /m3)	MINIMUM DETECTION LIMIT (mg /m3)	ACCURACYOF FACTORY CALIBRATION	RESOLUTION (mg /m3)	RESPONSE TIME (S)	OPERATING CONDITIONS		APPLICATION TYPE		
								TEMP	RH	ENV	IAQ	IND
(PM <sub>2.5</sub> ) (PM <sub>10</sub> )	PM	LPC	0.001-1.000	0.001	±0.005 mg/m <sup>3</sup> + 15%	0.001	5	0 to 40°C	0 to 90%	✓	✓	✓

#### Handheld Unit Compatible Firmware Versions

The PM sensor head is compatible with handheld units only.

- S200: V5.3 or higher
- S300: V6.3 or higher
- S500: V6.4 or higher

#### Application

The PM Sensor Head is suitable for a wide range of applications, indoor or outdoor. Ranging from indoor air quality monitoring, construction dust monitoring, monitoring transport emissions, smog monitoring, community exposure studies and air quality model validation. The PM sensor head is not designed for long term outdoor use and as sensitive scientific equipment care must be taken to avoid damage via weather conditions, vibration and impact.

#### USA EPA Air Quality Index Values for PM10 and PM2.5

PM10, 24hr	PM2.5, 24hr	AQI	EPA Term
mg/m <sup>3</sup>	mg/m <sup>3</sup>		
0 – 0.054	0 – 0.012	0-50	Good
0.055 – 0.154	0.0121 – 0.0354	51-100	Moderate
0.155 – 0.254	0.0355 – 0.0554	101-150	Unhealthy for Sensitive Groups
0.254 – 0.354	0.0555 – 0.1504	151-200	Unhealthy
0.355 – 0.424	0.1505 – 0.2504	201-300	Very Unhealthy
0.421 – 0.600	0.2505 – 0.5004	300-500	Hazardous

Source: Revised Air Quality Standards For Particle Pollution And Updates To The Air Quality Index (AQI). North Carolina: US EPA Office of Air Quality Planning and Standards. 2013.

#### Operation

The PM Sensor Head uses a laser and optical sensor to measure light scattered from particles passing through the laser beam. The sensor head also compensates for humidity by way of an on-board humidity sensor. In humid conditions, light scattering sensors are likely to read high because moisture surrounds particles, causing them to appear ‘bigger’. The humidity compensation feature reduces this effect on the measurement. In the case of the Series 300 and 500 base units, a gain (or

K factor) can be applied to the sensor output. This allows users to adjust the readings relative to a trusted source such as EPA-approved reference monitor.

### Operating Life

The laser diode within the PM Sensor Head has an operating life of up to 8000 hours. This provides an expected life span of 2 years for typical portable monitor applications. The sensor head may be returned to Aeroqual for factory servicing and calibration as required.

### Data Logging (Series 500)

The PM sensor head measures 2 simultaneous readings, PM10 and PM2.5. The Series 500 handheld unit can store a limited number of data points (8188) this means that the length of time that data can be logged depends upon the frequency and number of data points recorded. Once Capacity is reached new data will begin to overwrite the oldest logged data.

Maximum Period to be Logged						
		Logging Frequency				
		1 min	5 min	10 min	30 min	1 hr
Data Points	4 (PM 2.5, PM 10, Temp & RH)	33 hours	165 hours	330 hours	990 hours	1980 hours
	2	66 hours	330 hours	660 hours	1980 hours	3960 hours

Version 6.5 or higher of the Aeroqual Series 500 software is required for export of the logged data to PC.

The latest PC software is available from: <https://www.aeroqual.com/support/product-software>



## 13.7 Volatile Organic Compound (VOC) sensors

Aeroqual offers three different types of sensor for measurement of volatile organic compounds (VOCs): PID, GSS VOC and GSS NMHC.

Aeroqual VOC (Volatile Organic Carbon) sensors	
PID (10.6 eV)	Photoionization Detector 10.6 electron Volts.
GSS VOC	Gas Sensitive Semiconductor Volatile Organic Carbon
GSS NMHC	Gas Sensitive Semiconductor Non Methane Hydrocarbon

These sensors have been designed to respond to a broad range of VOCs although they each display a unique sensitivity to certain VOCs or classes of hydrocarbon, see diagram above.

- The three sensors are all sensitive towards aromatic hydrocarbons.
- None of the sensors respond to methane.
- The NMHC sensor, and VOC sensor show unique sensitivity towards certain organic compounds as shown below.

These differences and similarities in selectivity of the different compounds should be considered when choosing a sensor for a particular application.

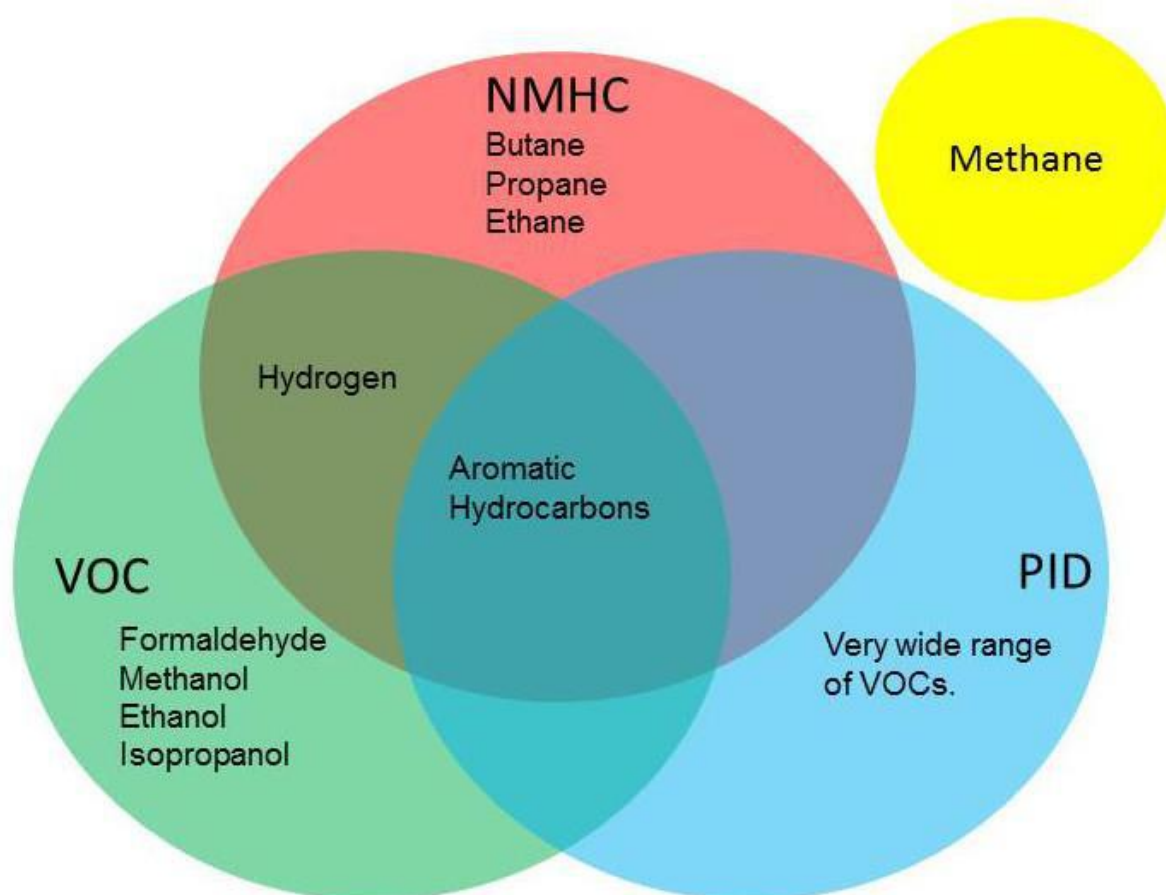

The Aeroqual products which support the different types of VOC sensor are shown in the table below.

Sensor	Products
PID	AQM 65, Portable Series, 900 Series
GSS VOC	Portable Series, 900 Series
GSS NMHC	AQM 65, Portable Series, 900 Series

### Calibration, and correction factors for Aeroqual VOC sensors:

All VOC sensors are calibrated at the Aeroqual factory using **isobutylene**. This means in the presence of 1 ppm isobutylene all three sensors will report 1 ppm.

The isobutylene conversion factor from ppm to mg/m<sup>3</sup>: 1 ppm = 2.29 mg/m<sup>3</sup>

However in the presence of other volatile organic compounds the response will very different for each sensor type. Correction factors for a range of different gases for the PID sensor are listed below.

**NOTE:** If the GSS VOC or GSS NMHC sensor is being used to measure another organic compound Aeroqual advises to calibrate the VOC sensor towards that compound using a gas standard comprised of that compound.

Other related compounds can be measured using Aeroqual's specific sensors.

Gas Sensor	Code	Sensor	Range (ppm)	Minimum Detection Limit (ppm)	Accuracy of Calibration	Resolution (ppm)	Operational Range	
							Temp.	RH
Methane (CH <sub>4</sub> )	MT	GSS	0-10000	10	<±20 ppm +15%	1	0 to 40°C	10 to 90%
Formaldehyde (CH <sub>2</sub> O)	EF	GSE	0-10	0.01	<±0.05 ppm @ 0-0.5 ppm <± 10% @ 0.5-10 ppm	0.1	0 to 40°C	10 to 90%
Perchloroethylene (C <sub>2</sub> Cl <sub>4</sub> )	PE	GSS	0 - 200	1	<±5 ppm @ 0-50 ppm <± 10% @ 50-200 ppm	1	0 to 40°C	10 to 90%
Hydrogen (H <sub>2</sub> )	HA	GSS	0-5000	5	<±10 ppm +10%	1	0 to 40°C	10 to 90%

**NOTE:** If the atmosphere being measured contains a mixture of hydrocarbons, which is likely the case when measuring outdoor ambient air, then the measurement should be considered to be qualitative only.

### Aeroqual PID sensor response correction factors

The Aeroqual PID sensor response to a variety of gases is given in the table below. The Response Factor (RF) provides a sensitivity measure relative to isobutylene (RF=1). The PID sensor is more sensitive to compounds with lower RF values. Compounds not listed may also be detected by PID - For more information [contact Aeroqual](#).

### VOC (PID) Sensor Specifications

Gas Sensor	Code	Sensor	Range (ppm)	Minimum Detection Limit (ppm)	Accuracy of Calibration	Resolution (ppm)	Operational Range	
							Temp.	RH
VOC	PDL	PID	0-20	0.01	<±10%	0.01	0 to 40°C	10 to 90%
VOC	PDH	PID	0-1000	0.2	<±10%	0.1	0 to 40°C	10 to 90%

## Response Factors (RF)

The default sensor concentration reading is in units of ppm of Isobutylene. The user can convert this into ppm of another gas by multiplying the reading by the response factor (RF) listed in the table below.

### **Response factor example**

The PID sensor head is calibrated against Isobutylene and is being used to measure the concentration of heptane.

The reading in ppm of Isobutylene is 10ppm.

Therefore the concentration of heptane is  $10 \text{ ppm} \times 2.5 = 25 \text{ ppm}$ .

The VOC sensor can also be used to qualitatively indicate the total VOC level. The units of measurement are ppm Isobutylene equivalent.

This following list of PID correction factors is a shortened list reproduced from:

<http://www.alphasense.com/WEB1213/wp-content/uploads/2014/06/AAN-305-05.pdf>

Compound	Response Factor (RF) (a smaller RF means the PID is more sensitive to the compound)
1,2,3-trimethylbenzene	0.49
1,2,4-trimethylbenzene	0.43
1,2-dibromoethane	11.7
1,2-dichlorobenzene	0.50
1,3,5-trimethylbenzene	0.34
1,4-dioxane	1.4
1-butanol	3.4
1-methoxy-2-propanol	1.4
1-propanol	5.7
2-butoxyethanol	1.3
2-methoxyethanol	2.5
2-pentanone	0.78
2-picoline	0.57
3-picoline	0.90
4-hydroxy-4-methyl-2-pentanone	0.55
acetaldehyde	10.8
acetic acid	11.0
acetone	1.2
acetophenone	0.59
acrolein	3.9
allyl alcohol	2.5
ammonia	9.4
amylacetate	3.5
arsine	2.6
benzene	0.53
bromoform	2.3
bromomethane	1.8
butadiene	0.69
butyl acetate	2.4
carbon disulfide	1.2
chlorobenzene	0.4
cumene (isopropylbenzene)	0.54
cyclohexane	1.5
cyclohexanone	0.82
decane	1.6
diethylamine	1.0

<b>Compound</b>	<b>Response Factor (RF)</b> (a smaller RF means the PID is more sensitive to the compound)
dimethoxymethane	11.3
dimethyl disulfide	0.3
diesel fuel #1	0.9
diesel fuel #2	0.75
epichlorhydrin	7.6
ethanol	10.0
ethyl acetate	4.2
ethyl acetoacetate	0.9
ethyl acrylate	2.3
diethyl ether	1.2
ethyl mercaptan	0.6
ethylbenzene	0.51
ethylene	10.1
gasoline	1.1
heptane	2.5
hydrazine	2.6
hydrogen sulfide	3.2
isoamyl acetate	1.8
isobutanol	4.7
isobutyl acetate	2.6
isobutylene	1.0
isooctane	1.3
isopentane	8.0
isophorone	0.74
isoprene (2-methyl-1,3-butadiene)	0.6
isopropanol	5.6
isopropyl acetate	2.6
isopropyl ether	0.8
isopropylamine	0.90
Jet A Fuel	0.4
JP-5 Fuel	0.48
JP-8 Fuel	0.48
mesityl oxide	0.47
methyl acetate	7
methyl acetoacetate	1.1
methyl acrylate	3.4
methyl benzoate	0.93
methyl ethyl ketone	0.9
methyl isobutyl ketone	1.1
ketone	1.1
methyl mercaptan	0.6
methyl methacrylate	1.5
methyl tert-butyl ether	0.86
ether	0.86
methylamine	1.2
methylbenzil alcohol	0.8
m-xylene	0.53
naphtalene	0.37
n,n-dimethylacetamide	0.73
n,n-dimethylformamide	0.80
n-hexane	4.5
nitric oxide	7.2
n-nonane	1.6
n-pentane	9.7
n-propyl acetate	3.1

Compound	Response Factor (RF) (a smaller RF means the PID is more sensitive to the compound)
octane	2.2
o-xylene	0.54
phenol	1.0
phosphine	2.8
pinene, alpha	0.4
pinene, beta	0.4
propylene	1.3
propylene oxide	6.5
p-xylene	0.50
pyridine	0.79
quinoline	0.72
styrene	0.40
tert-butyl alcohol	3.4
tert-butyl mercaptan	0.55
tert-butylamine	0.71
tetrachloroethylene	0.56
tetrahydrofuran	1.6
thiophene	0.47
toluene	0.53
trans-1,2-Dichloroethene	0.45
trichloroethylene	0.50
trimethylamine	0.83
turpentine crude sulfite	1.0
turpentine pure gum	0.45
vinyl acetate	1.3
vinyl bromide	0.4
vinyl chloride	1.8
vinylcyclohexane (VCH)	0.54
vinylidene chloride (1,1-DCE)	0.8

### Aeroqual GSS sensor response correction factors

The Aeroqual GSS sensor response to a selection of gases is given in the table below. The Response Factor (RF) provides a sensitivity measure relative to isobutylene (RF=1). The GSS sensor is more sensitive to compounds with lower RF values. Compounds not listed may also be detected by GSS - For more information [contact Aeroqual](#).

### VOC (GSS) Sensor Specifications

Gas Sensor	Code	Sensor	Range (ppm)	Minimum Detection Limit (ppm)	Accuracy of Calibration	Resolution (ppm)	Operational Range	
							Temp.	RH
VOC	VM	GSS	0-25	0.1	<±0.1 ppm + 10 %	0.01	0 to 40°C	10 to 90%
VOC	VP	GSS	0-500	1	<± 5ppm + 10 %	0.1	0 to 40°C	10 to 90%

Compound	Response Factor (RF) (a smaller RF means the GSS is more sensitive to the compound)
CO	10
propane	80
toluene	1
butane	20
ethanol	0.15

<b>Compound</b>	<b>Response Factor (RF)</b> (a smaller RF means the GSS is more sensitive to the compound)
ethyl acetate	0.2
isopropanol (IPA)	0.07
SO <sub>2</sub>	0.2
H <sub>2</sub> S	0.02
heptane	3
hydrogen	10
dodecane	2.5

## 14 Copyright

Copyright Aeroqual Limited. All rights reserved. Reproduction, transfer, distribution or storage of part or all of the contents of this document in any form without the prior written permission of Aeroqual Limited is prohibited.

“Aeroqual” and “Aeroqual Limited – Making the Invisible Visible” are registered trademarks of Aeroqual Limited. Other product and company names mentioned herein may also be trademarks or trade names.

Aeroqual operates a policy of continuous development. Aeroqual re-serves the right to make changes and improvements to any of the products described in this document without prior notice.

Under no circumstances shall Aeroqual be responsible for any loss of data or income or any special, incidental, consequential or indirect damages howsoever caused.

The contents of this document are provided "as is". Except as required by applicable law, no warranties of any kind, either express or implied, including, but not limited to, the implied warranties of merchantability and fitness for a particular purpose, are made in relation to the accuracy, reliability or contents of this document.

Aeroqual reserves the right to revise this document or withdraw it at any time without prior notice. The availability of particular products may vary by region. Please check with the Aeroqual dealer nearest to you.

## 15 Software License

The Series 500 monitor comes supplied with Aeroqual data logging software. Aeroqual will retain ownership of all intellectual property in the Software. The buyer acknowledges that they are granted a perpetual, non-exclusive, non-transferable license for the right to use the Software for the buyer's exclusive use and only in conjunction with Aeroqual Products (Intended use). The buyer will strictly adhere to the Intended Use of the Software and will not translate, adapt, reverse compile or otherwise alter the Software. The buyer undertakes not to disclose, assign, sell, rent, lend, sub license or otherwise transfer the Software.

## 16 Terms and Conditions

This product is warranted according to Aeroqual Ltd's Terms of Trade. For further warranty information, please refer to the standard Product Warranty Policy as published on the Aeroqual website at [www.aeroqual.com](http://www.aeroqual.com).

## 17 Statements of Compliance

- The Aeroqual Series 200, 300 and 500 Monitors and Remote Adaptor Kit comply with EN 50082-1:1997
- The Aeroqual Series 200, 300 and 500 Monitors and Remote Adaptor Kit comply with EN 50081-1:1992
- The Aeroqual Series 200, 300 and 500 Monitors and Remote Adaptor Kit comply with Part 15 of the FCC Rules. Operation is subject to the following two conditions: (1) these devices may not cause harmful interference, and (2) these devices must accept any interference received, including interference that may cause undesired operation.

NOTE: This equipment has been tested and found to comply with the limits for a Class B digital device, pursuant to Part 15 of the FCC Rules. These limits are designed to provide reasonable protection against harmful interference in a residential installation. This equipment generates, uses and can radiate radio frequency energy and, if not installed and used in accordance with the instructions, may cause harmful interference to radio communications. However, there is no guarantee that interference will not occur in a particular installation. If this equipment does cause harmful interference to radio or television reception, which can be determined by turning the equipment off and on, the user is encouraged to try to correct the interference by one or more of the following measures:

- Reorient or relocate the receiving antenna.
- Increase the separation between the equipment and receiver.
- Connect the equipment into an outlet on a circuit different from that to which the receiver is connected.
- Consult the dealer or an experienced radio/TV technician for help.