



**KANOMAX**

# Anemomaster

MODEL 6162

## Operation Manual

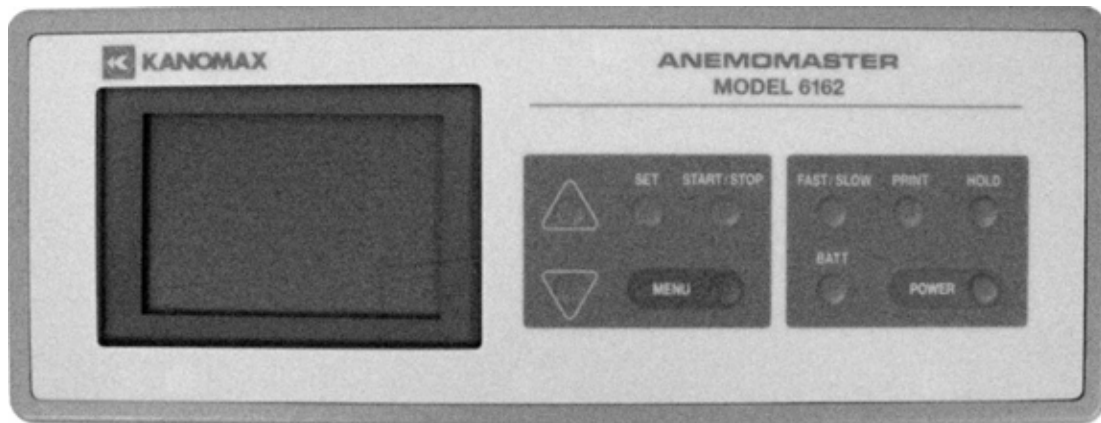

Read this operation manual carefully and understand the warnings described in this manual before operating the product.  
Keep this manual handy for future reference.



03001

1109

# Important Safety Information

Types and definitions of warnings signs used in this operation manual are described as below.

## [Classifications]



### **WARNING: To Prevent Serious Injury or Death**

Indicates a potentially hazardous situation which, if not avoided, may result in serious injury or death.



### **CAUTION: To Prevent Damage to the Product**

Indicates a potentially hazardous situation which, if not avoided, may result in damage to the product that may void the product warranty.

## [Description of Symbols]









△ indicates the condition (including danger) that requires caution. The subject of each caution is illustrated inside the triangle (e.g., the symbol shown on the left is high temperature caution).



⊘ indicates prohibition. Do not take the prohibited action shown inside or near this symbol (e.g., the symbol on the left prohibits disassembly).

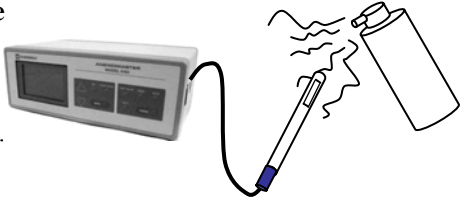

● indicates a mandatory action. A specific action is given near the symbol.

 <b>WARNING</b>	
 Do not use near flammable gas.	<p>➤ <b>Never bring the probe close to a flammable gas atmosphere.</b></p> <p>&gt;&gt;&gt;&gt; The heated sensor may cause fire or explosion.</p> 
 Do not modify / disassemble.	<p>➤ <b>Never disassemble, modify or repair the product.</b></p> <p>&gt;&gt;&gt;&gt; Failure to observe the above may cause short circuit and/or other failure that will affect the performance.</p>
 Handle properly	<p>➤ <b>Carefully follow the instructions provided in this Manual.</b></p> <p>&gt;&gt;&gt;&gt; Failure to observe the instructions may lead to electrical shock, fire or damage to the instrument.</p>
	<p>➤ <b>If abnormal noise, smell or smoke is observed, or if liquid has entered the instrument, turn off the instrument immediately, and remove the batteries or pull out the plug.</b></p> <p>&gt;&gt;&gt;&gt; There is a possibility of malfunction, electric shock, and fire. Please contact your local distributor or our service center for repair.</p>

**⚠ WARNING**



Prohibition

➤ **Do not use the instrument in a water vapor atmosphere.**

>>> Failure to observe above may cause electrical shock, fire, or damage to the sensor.

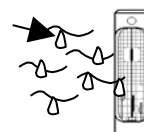

High Temperature  
Warning

➤ **Never touch the sensor.**

>>> The sensor is heated during operation.  
Touching the heated sensor may cause burns, and may also damage the sensor itself.

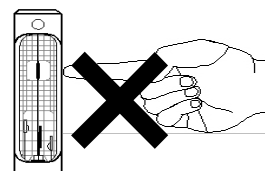

**⚠ CAUTION**



➤ **Always unplug the instrument from the electrical outlet when the instrument is not in use.**

>>> Failure to do so may cause electrical shock, fire or circuit damage.



Handle carefully

➤ **Remove the batteries from the battery compartment when storing the instrument.**  
➤ **DO not leave exhausted batteries in the battery compartment.**

>>> Failure to do so may cause battery leakage.



Prohibited  
Installation

➤ **Do not use or leave the instrument in a high temperature / humidity environment, or in a dusty environment.**  
➤ **Do not leave the instrument under direct sunlight for a prolonged period.**

>>> The instrument may not function properly out of the specified operating conditions.

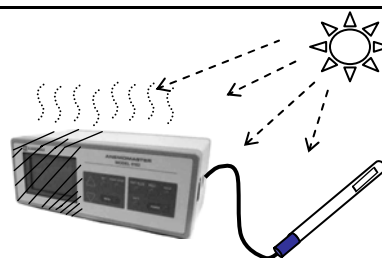

Prohibition

➤ **Do not wipe the instrument with a volatile solvent.**

>>> The body may deform or deteriorate. Use soft dry cloth to remove stains. If stains persist, soak the cloth in a neutral detergent and wipe the instrument with the soft cloth. Never use volatile solvents such as thinner or benzene.



Prohibition

➤ **Do not apply strong shock or place / drop anything heavy on the instrument.**

>>> Failure to observe the above may cause damage or malfunction to the instrument.

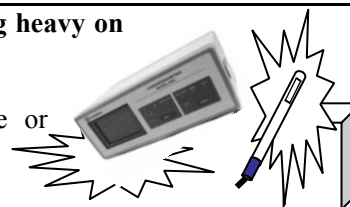

➤ **Do not touch the sensor when the sensor is charged.**

>>> Failure to observe the above may affect the measurement value or cause the circuit failure.



# Table of Contents

1. Getting Started.....	1
1.1 Part Names and Functions (1) ..... Main Unit.....	1
1.2 Part Names and Functions (2) ..... Probe .....	3
1.3 Sheet Key Description .....	4
1.4 Power Source.....	5
1.4.1 Battery Replacement .....	5
1.4.2 AC Adapter.....	5
1.5 Getting Ready for Measurement .....	6
1.5.1 Connecting a Probe Cable.....	6
1.5.2 Checking the Probe Number .....	6
1.5.3 To Attach and Detach the Probe Board .....	6
1.5.4 Display Screen – Monitor Screen .....	7
2. Basic Operation.....	8
2.1 How to Hold Reading .....	8
2.2 How to Make the Reading More Readable.....	9
2.3 How to Display Fluctuation Graph .....	10
2.4 Remaining Battery Level .....	11
2.4.1 Battery Level Indicator .....	11
2.5 How to Change Data and Time.....	12
2.6 Printing Hard Copy of the Monitor Screen.....	13
2.6.1 What you need.....	13
2.6.2 Printer Setting.....	13
2.6.3 Signal Cable Connection .....	13
2.6.4 Operation Procedure .....	13
3. Measurement Mode.....	14
3.1 How to Measure Average, Max and Min value [Average Mode] .....	14
3.2 How to Collect Data at Certain Time Intervals [Interval Mode] .....	16
3.3 How to Measure Flow Rate in the Duct [Flow Rate Mode] .....	18
3.4 Program Set.....	20
3.4.1 How to Pre-set Measurement Mode.....	20
3.4.2 Other Calculation Mode Cannot be Used.....	21
3.4.3 How to Deactivate Pre-set Measurement Mode .....	21
3.5 Memory Capacity .....	22
3.5.1 “Memory Over” Display .....	23
3.6 Printing Example – Automatic Printing and Hardcopy of Calculation Result.....	24
3.6.1 Automatic Printing Example .....	24
3.6.2 Hardcopy Example.....	24

<b>4. How to Redisplay, Print and Delete Stored Data</b> .....	25
<b>4.1 How to Redisplay Data</b> .....	25
<b>4.2 How to Output Data to Printer</b> .....	26
<b>4.2.1 Procedure for outputting data to a printer</b> .....	26
<b>4.3 Deleting Memory Data</b> .....	28
<b>4.3.1 Deleting All</b> .....	28
<b>4.3.2 Deleting Selected Pages Only</b> .....	29
<b>5. Data Output</b> .....	30
<b>5.1 Analog Output</b> .....	30
<b>5.1.1 How to Change Air Velocity Range</b> .....	30
<b>5.2 Digital Output (RS-232C)</b> .....	32
<b>5.2.1 Connection Example</b> .....	32
<b>5.2.2 Baud Rate Setting</b> .....	32
<b>5.2.3 To Transfer Raw Data (measurement data per second)</b> .....	33
<b>5.2.4 To Transfer Memory Data (Measurement Data Stored in Memory)</b> .....	34
<b>6. Main Specification</b> .....	36
<b>7. Measurement Principle</b> .....	38
<b>7.1 Principle of Hot-Wire Anemometer</b> .....	38
<b>7.2 Temperature Compensation</b> .....	39
<b>7.3 Influence by Gas Composition to be Measured</b> .....	40
<b>8. Troubleshooting</b> .....	42
<b>8.1 Checking Power Source</b> .....	42
<b>8.2 Checking the Initial Operation</b> .....	42
<b>8.3 During a Measurement</b> .....	43
<b>8.4 Analog Output</b> .....	43
<b>8.5 Digital Output</b> .....	43
<b>8.6 Printer</b> .....	43
<b>9. Warranty and After-sales Service</b> .....	44
<b>10. Contact Information</b> .....	46

# 1. Getting Started

## 1.1 Part Names and Functions (1) ----- Main Unit

Unit: mm

[Front]

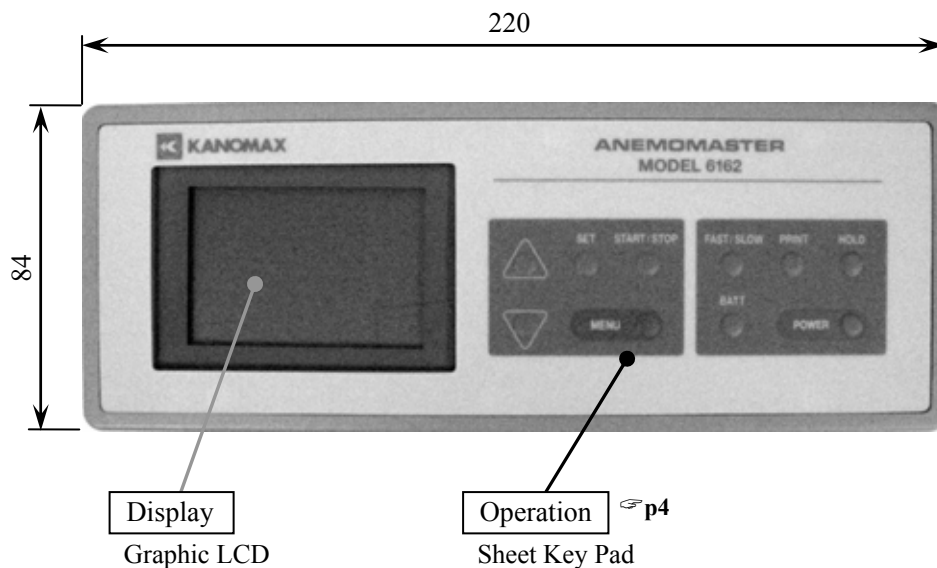

[Bottom]

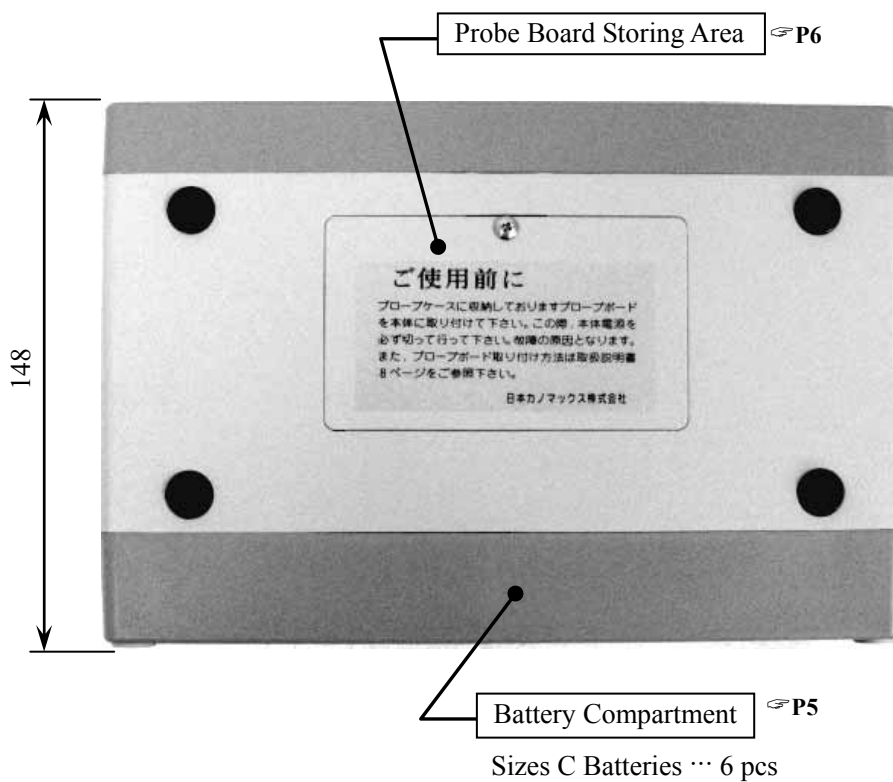

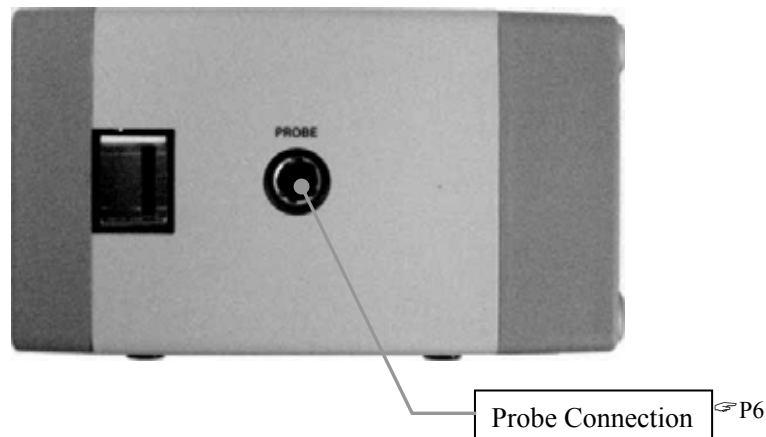
**[Right Side]****[Left Side]****Backlight Switch**

Turn this ON to make the LCD screen be backlit so that you can see the screen clearer even in a dark place.

\* Turn the backlight on only at the time of need in order to prevent battery drain.

**Brightness Adjustment Volume**

Turn the volume to the right and left to change the brightness of the display. Adjust the volume to make the displayed letters easily viewable.

**Digital Output Terminal**

RS-232C (serial output)  
To output raw data or memory data to a computer or printer P13, 32

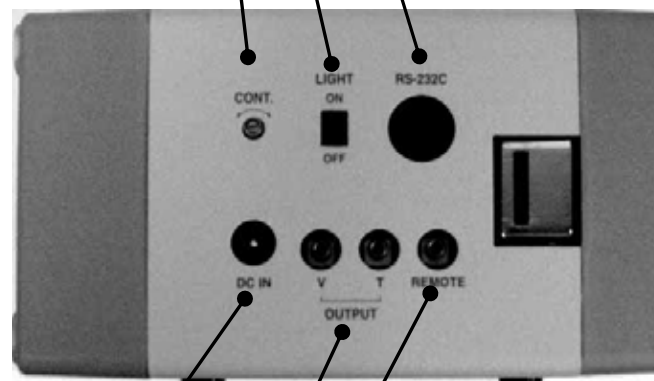
**AC Adapter Jack**

Use the provided adapter. When the AC adapter is connected, it will have a priority.

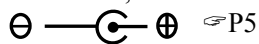
**Analog Output**

Air velocity and temperature are output simultaneously. P30

Output Voltage: DC0 ~ 1V

The output range can be changed from the menu.

**Remote Terminal**

Use this to use the remote control function  
It responds to **START/STOP** key and **HOLD** key in the operation area. This can be used to start/stop a measurement or hold the screen.



## 1.2 Part Names and Functions (2) ----- Probe

### [Probe for Medium Temperature] --- MODEL 0203

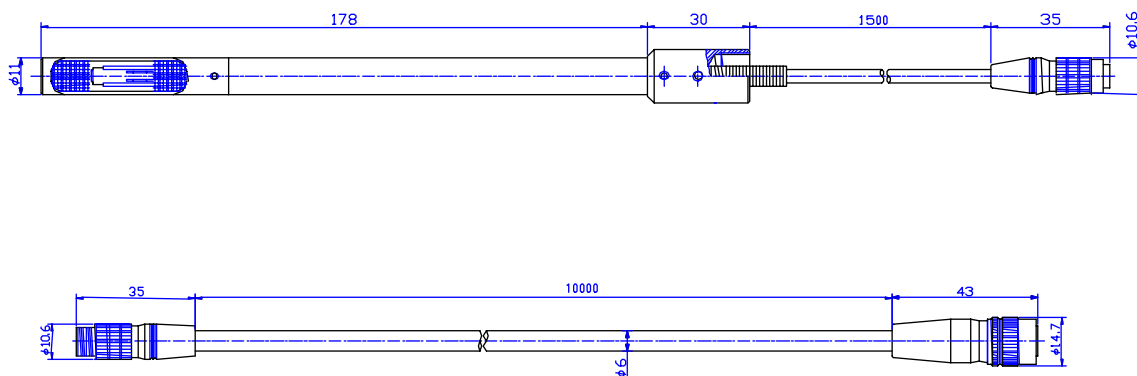



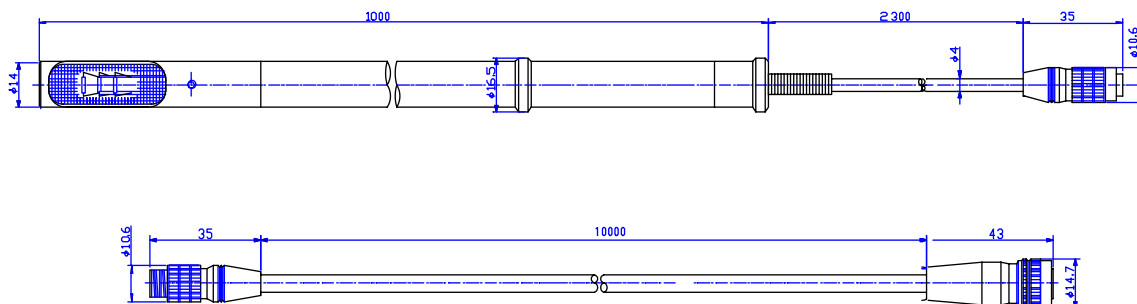



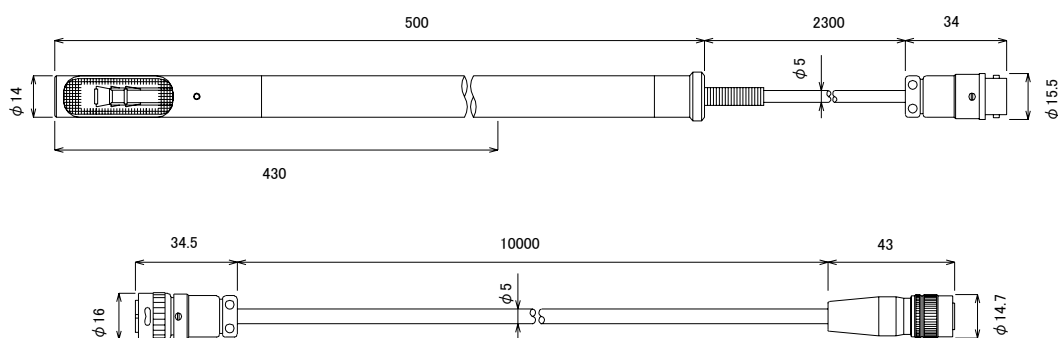

### [Probe for High Temperature] --- MODEL 0204



### [Probe for High Temperature] --- MODEL 0205



### 1.3 Sheet Key Description

POWER	Turn ON/OFF the power.				
HOLD	Hold the reading and release to hold the reading.				
PRINT	After holding the display screen, press <b>PRINT</b> key to output the hardcopy of the displayed screen via external printer.				
FAST/SLOW	The instrument can be switched into FAST, SLOW1 or SLOW 2. <div data-bbox="416 674 1177 801" style="border: 1px solid black; padding: 5px; margin: 10px 0;"> <p>FAST: To display the instantaneous value every 1 sec                  SLOW1: To display moving average deviations for 5 seconds                  SLOW2: To display moving average deviations for 10 seconds</p> </div> <p>* This feature cannot be used in the calculation measurement function.</p>				
BATT	To display the remaining battery level This function is available only when batteries are used.				
MENU	Select each function. There are following functions in this menu. <div data-bbox="432 1093 1331 1487" style="border: 1px solid black; padding: 10px; margin: 10px 0;"> <table style="width: 100%; border-collapse: collapse;"> <tr> <td style="text-align: center; border: 1px solid black; padding: 5px;">                     &lt; MENU &gt;                      1. MONITOR .....                      2. MEASUREMENT .....                      3. DATA OUTPUT .....                      4. MEMORY CLEAR .....                      5. UTILITY ---                 </td> <td style="padding-left: 10px; vertical-align: top;">                     .....Change to the monitoring screen.                      ..... Measurement mode (average, interval, flow rate)                      ..... To output memory data (display screen, printer, RS-232C)                      ..... To delete memory data                 </td> </tr> </table>   <table style="width: 100%; border-collapse: collapse;"> <tr> <td style="text-align: center; border: 1px solid black; padding: 5px;">                     &lt; UTILITY &gt;                      1. CALENDAR .....                      2. ANALOG OUTPUT .....                      3. PROGRAM SET .....                      4. RS-232C .....                 </td> <td style="padding-left: 10px; vertical-align: top;">                     ..... Date setting                      ..... Analog output range switching                      ..... Measurement mode setting                      ..... Baud rate (communication speed) setting                 </td> </tr> </table> </div>	< MENU > 1. MONITOR ..... 2. MEASUREMENT ..... 3. DATA OUTPUT ..... 4. MEMORY CLEAR ..... 5. UTILITY ---	.....Change to the monitoring screen. ..... Measurement mode (average, interval, flow rate) ..... To output memory data (display screen, printer, RS-232C) ..... To delete memory data	< UTILITY > 1. CALENDAR ..... 2. ANALOG OUTPUT ..... 3. PROGRAM SET ..... 4. RS-232C .....	..... Date setting ..... Analog output range switching ..... Measurement mode setting ..... Baud rate (communication speed) setting
< MENU > 1. MONITOR ..... 2. MEASUREMENT ..... 3. DATA OUTPUT ..... 4. MEMORY CLEAR ..... 5. UTILITY ---	.....Change to the monitoring screen. ..... Measurement mode (average, interval, flow rate) ..... To output memory data (display screen, printer, RS-232C) ..... To delete memory data				
< UTILITY > 1. CALENDAR ..... 2. ANALOG OUTPUT ..... 3. PROGRAM SET ..... 4. RS-232C .....	..... Date setting ..... Analog output range switching ..... Measurement mode setting ..... Baud rate (communication speed) setting				
START/STOP	Start/Stop a measurement				
 	Initial Screen:  key: Press it to display variation graph for air velocity and press it again to switch the range. (There are 6 ranges; 50, 25, 10, 5, 2, 1 m/s.)  key: Use this key to go back to the original screen.				
SET	Use this key to execute the selected item.				
 	Menu Screen: Use   keys to select the function and item as well as to set numeric value.				

## 1.4 Power Source

### 1.4.1 Battery Replacement

#### 1. How to Open the Battery Cover



Push the click up towards the arrow direction to remove the lid.

#### 2. How to Remove the Batteries

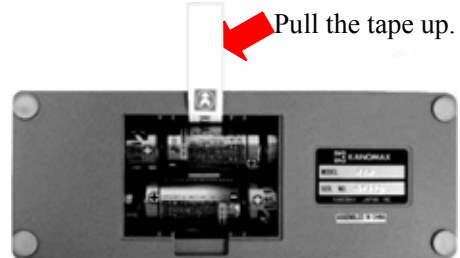

#### 3. How to Install Batteries

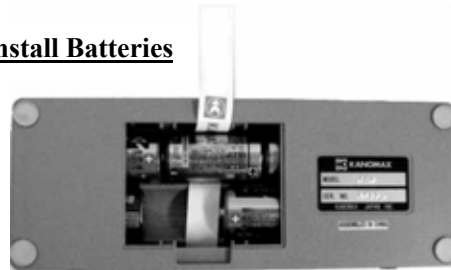

- \* Insert the middle batteries at last after placing the batteries at the both sides.  
Make sure to place the tape under the battery as shown in the above picture.

<<CAUTION>>

**Make sure the polarity is right.**

**Install the batteries by observing the polarity. If not, it may cause malfunction due to short-circuit or heatup.**

**Install the batteries properly following the directions indicated on the bottom of the battery compartment.**

### 1.4.2 AC Adapter

When the AC adapter is connected, it has a priority. It does not cause any problems even if the batteries are still installed. However, if you do not use the instrument for a prolonged time, remove the batteries. Otherwise, it may cause the contact failure due to the battery corrosion.

<<CAUTION>>

**Use our designated AC adapter.**

**Other AC adapters on the market place may have different polarity.**

**=> It may cause short circuit or fire.**

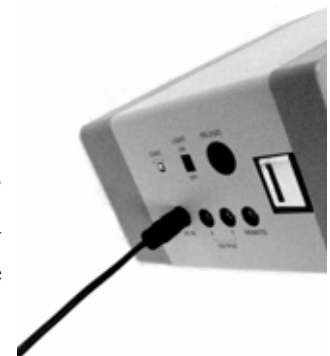

AC Adapter	
<b>MODEL 6113-02</b>	
INPUT: 100-240VAC 50-60Hz	
OUTPUT: 9VDC 2A	
Connector	

## 1.5 Getting Ready for Measurement

### 1.5.1 Connecting a Probe

Probe is calibrated together with the provided connection cable.  
Please make sure the connection cable is connected when performing a measurement.

\* To change the length of a connection cable, recalibration will be required.

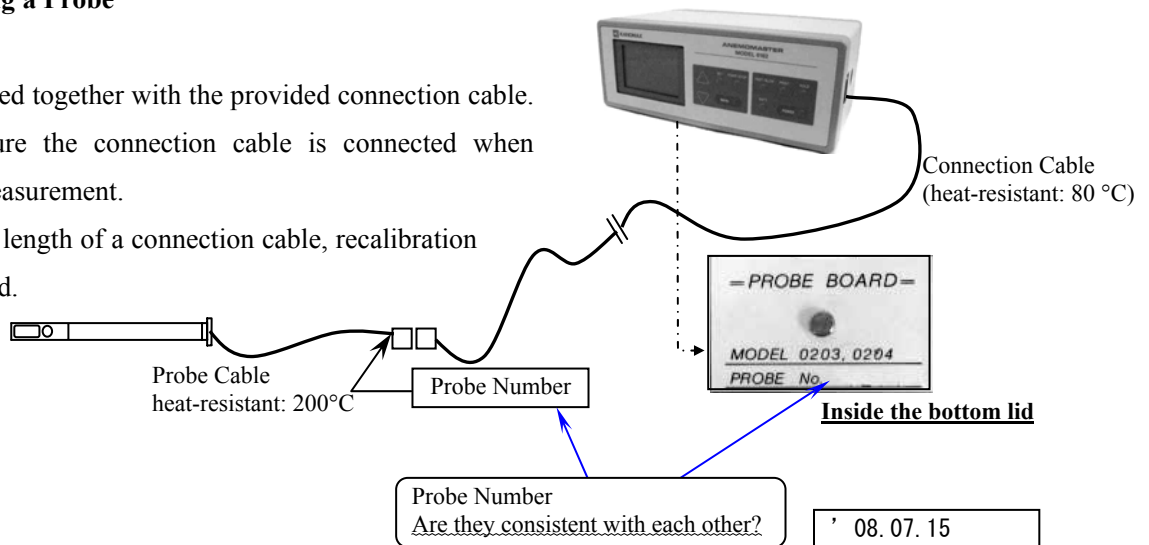

### 1.5.2 Checking the Probe Number

Confirm that the number indicated on the one end of the probe cable (Teflon cable) is consistent with the one indicated on the screen of the instrument.

\* This screen will be displayed when the instrument is turned ON without the probe connected to the instrument.

#### <<CAUTION>>

The probe number needs to be checked when multiple probes are purchased or the same probe is to be used with multiple Anemomasters or a spare probe is used.

>>> Calibration data of the probe is written on characteristic ROM installed on the bottom of the instrument. Please check the probe number because each probe has different characteristic.

### 1.5.3 To Attach and Detach the Probe Board

(1) Open the bottom lid.



(2) Loosen up the screw.

>>> The screw will not come out.



(3) Pull it up vertically.

As the board is connected to the connector, do not twist it or pull only one side.

>>> It may cause the connection failure.

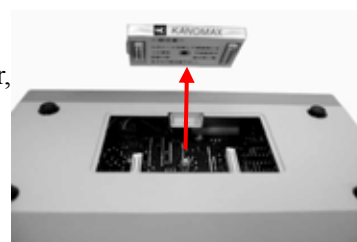

1.5.4 Display Screen – Monitor Screen

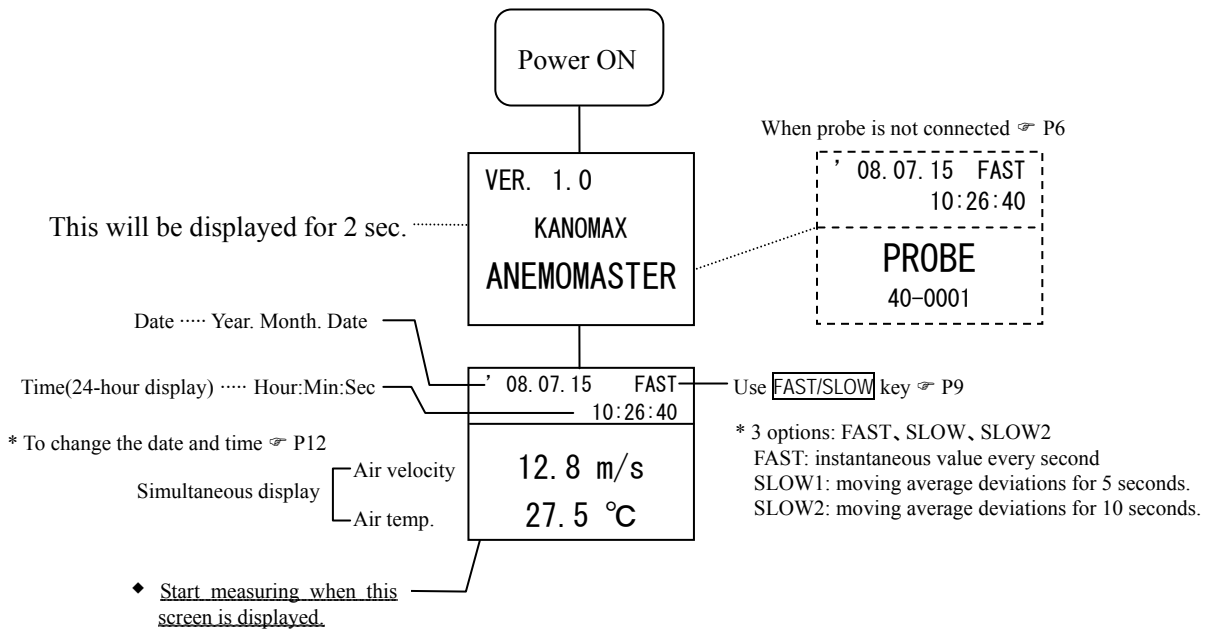

When the display does not change to the monitoring screen

Symptom	Solution
PROBE display remains. 	Probe is not connected.  ⇒ Turn the power OFF. Then after connecting the probe, turn the power ON again.
The responsiveness of reading is bad. 	Isn't SLOW1 or SLOW2 (displaying moving average deviations) displayed on the upper right corner of the screen?  ⇒ Press FAST/SLOW key to switch to FAST.
Date and time are not displayed. 	Calculation program is set.  ⇒ Press MENU key to select 1.MONITOR.

## 2. Basic Operation

### 2.1 How to Hold Reading

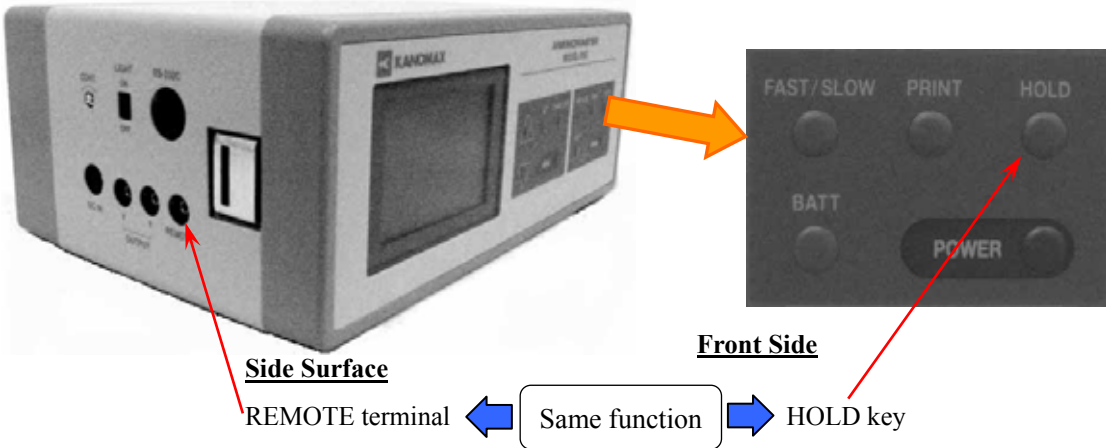

Display	key	Procedure
<div style="border: 1px solid black; padding: 5px; margin-bottom: 5px;">                     ' 08.07.01 FAST 10:26:40 5.38 m/s 25.7 ° C                 </div> <p style="text-align: center;">↓</p>	<div style="border: 1px solid black; padding: 2px; width: fit-content; margin: 0 auto;">HOLD</div>	Press <b>HOLD</b> key.
<div style="border: 1px solid black; padding: 5px; margin-bottom: 5px;">                     ' 08.07.01 FAST <b>hold</b> 10:26:40 5.38 m/s 25.7 ° C                 </div> <p style="text-align: center;">↓</p>		<b>hold</b> will be displayed on the upper left of the screen indicating that the reading is on hold.
<div style="border: 1px solid black; padding: 5px; margin-bottom: 5px;">                     ' 08.07.01 FAST 10:26:40 5.38 m/s 25.7 ° C                 </div>	<div style="border: 1px solid black; padding: 2px; width: fit-content; margin: 0 auto;">HOLD</div>	Press <b>HOLD</b> key again to release the hold function.

When the reading is hold.

' 08.07.01 FAST  
**hold** 10:26:40  
5.38 m/s  
25.7 ° C

- When a printer is connected, press **PRINT** key to print out the reading while the reading is on hold. For more details please refer to page 13.

## 2.2 How to Make the Reading More Readable

- ◆ This function is useful when you want to obtain averaged readings as readings were volatile.

\* This function is not available in Average Value Measurement Mode, Intermittent Operation Measurement Mode and Air Flow Measurement Mode.

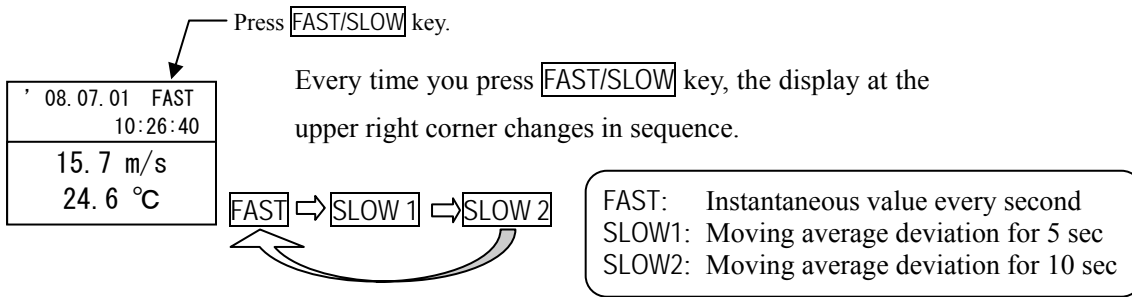









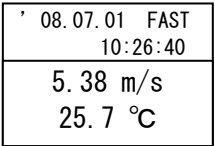

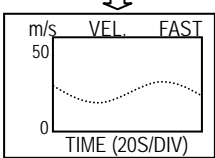

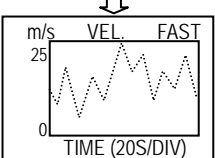

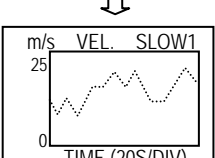

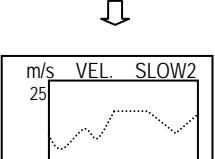

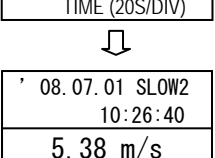

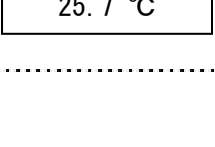
Mode	How to Take in Measurement Data	Explanation
FAST		Data is taken 4 times for one second. The average value of the 4 data is displayed as an instantaneous value every second.
SLOW 1		The average value for 5 seconds is displayed every second. Data shifts by 1 second.
SLOW 2		The average value for 10 seconds is displayed every second. Data shifts by 1 second.

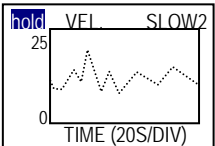
### 2.3 How to Display Fluctuation Graph

◆ You can monitor velocity fluctuation for 90 seconds.

(\* This function cannot be used in the calculation mode.)

Display	Key	Procedure
		Press  key. Range: 50, 25, 10, 5, 2, 1 m/s
		Press  key again. ★ Air velocity range changes.
		
		
		<b>FAST/SLOW key is useful when ...</b> >>> reading varies significantly and it is hard to see the graph. Press  key. ..... SLOW 1 (moving average deviations for 5 sec.)
		Press  key ..... SLOW 2 (moving average deviations for 10 sec.)
		Press  key to go back to the original screen.
		Press  key Display screen will be on hold. Even while the reading is on hold, you can still change the range and switch  .
		Press  key When the reading is on hold, the display can be printed out.

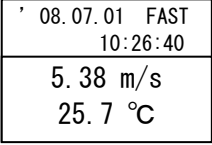
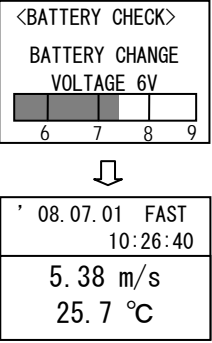

### 2.4 Remaining Battery Level

Display	Key	Procedure
	<p style="text-align: center;">BATT</p>	<p>This feature is available only on the monitoring screen or when the instrument is ready for a measurement in the measurement mode (when “ready” is displayed). On other screens this feature cannot be used.</p> <p>Press <b>BATT</b> key.</p>
		

#### 2.4.1 Battery Level Indicator

- ◆ When the remaining battery level becomes lower than 6V, the display screen will start blinking.

Please note that the reading when the screen is blinking cannot be guaranteed.

- \* Once the voltage of Ni-Cd battery becomes 6.5V or lower, the voltage will decrease at a rapid pace. Charge the batteries ahead of time.

- \* Using backlight drains battery quickly. Please use the backlight only when necessary.

Change the batteries when the screen starts blinking.

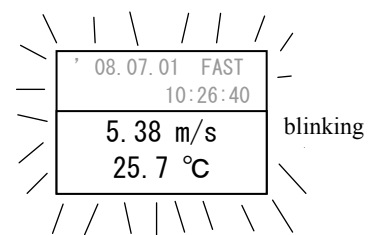

When the remaining battery capacity level becomes lower:

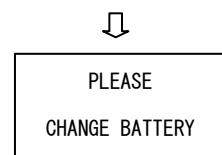

2.5 How to Change Data and Time

Display	Key	Procedure
↓		(1) Press  key.
<div style="border: 1px solid black; padding: 5px; margin-bottom: 5px;"> <p style="text-align: center;">&lt; MENU &gt;</p> <p>1. MONITOR 2. MEASUREMENT 3. DATA OUTPUT 4. MEMORY CLEAR 5. UTILITY</p> </div> <p style="text-align: center;">↓</p>	 	(2) Select 5. <u>UTILITY</u> . Then press  key.
<div style="border: 1px solid black; padding: 5px; margin-bottom: 5px;"> <p style="text-align: center;">&lt; UTILITY &gt;</p> <p>1. CALENDAR 2. ANALOG OUTPUT 3. PROGRAM SET 4. RS-232C</p> </div> <p style="text-align: center;">↓</p>	 	(3) Select 1. <u>CALENDAR</u> . Then press  key.
<div style="border: 1px solid black; padding: 5px; margin-bottom: 5px;"> <p style="text-align: center;">&lt; CALENDAR &gt;</p> <p>DATE 2008. 07. 01</p> <p>TIME 10 : 25</p> </div> <p style="text-align: center;">↓</p>	 	(4) Move the ▼ to the item to be changed. Then press  key.
<div style="border: 1px solid black; padding: 5px; margin-bottom: 5px;"> <p style="text-align: center;">&lt; CALENDAR &gt;</p> <p>DATE 2008. 07. 01</p> <p>TIME 10 : 25</p> </div> <p style="text-align: center;">↓</p>	 	(5) The figure to be changed will be highlighted. Then use  keys to change the figure. After the figure is changed, press  key.
<div style="border: 1px solid black; padding: 5px; margin-bottom: 5px;"> <p style="text-align: center;">&lt; CALENDAR &gt;</p> <p>DATE 2008. 07. 01</p> <p>TIME▼ 10 : 25</p> </div> <p style="text-align: center;">↓</p>		(6) To continue changing the date and time, repeat the above procedure (4) and (5) When you finished changing the data/time, press  key.
<div style="border: 1px solid black; padding: 5px; margin-bottom: 5px;"> <p style="text-align: center;">&lt; MENU &gt;</p> <p>1. MONITOR 2. MEASUREMENT 3. DATA OUTPUT</p> </div> <p style="text-align: center;">↓</p>	 	(7) Select 1. <u>MONITOR</u> . Then  key.
<div style="border: 1px solid black; padding: 5px; margin-bottom: 5px;"> <p>' 08.07.15 FAST 10:26:40</p> </div> <div style="border: 1px solid black; padding: 5px;"> <p style="text-align: center;">12.8 m/s 27.5 °C</p> </div>		(8) The display will return to the original screen. Then check if the date/time is changed correctly.

\* **Second is not configurable.**

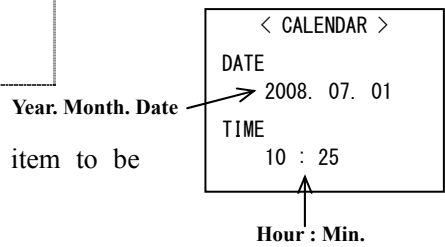

## 2.6 Printing Hard Copy of the Monitor Screen

### 2.6.1 What you need

- ★ Printer (sold separately) …… Recommended model is DPU-201GS (Seiko Instruments Inc.)
- ★ Cable to connect the instrument and a printer (sold separately)

### 2.6.2 Printer Setting

Switch No.	Function	Anemomaster	Printer
SW 1	Word Length	8 bit	ON
SW 2	Parity Yes/No	None	ON
SW 3	Parity Setting	None	ON
SW 4~6	Baud Rate	4800	Table Below

Baud Rate	SW 4	SW5	SW6
4800	OFF	ON	OFF

### 2.6.3 Signal Cable Connection

Anemomaster		Printer	
Signal Pin No.	Signal Name	Signal Pin No.	Signal Name
3 (orange)	TXD	3	DATA
1 (brown)	GND	5	GND
4 (yellow)	CTS	8	BUSY

### 2.6.4 Operation Procedure

1. Connect the instrument (RS-232C output terminal) and a printer.
2. Turn on both of the instrument and the printer.
3. Confirm that the Anemomaster's display is an initial screen.
4. Press **HOLD** key to hold the display screen.
5. When the display is on hold, press **PRINT** key.

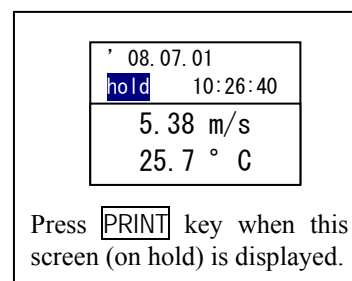

### To Halt Printing Temporarily and To Cancel Printing

- ◆ Temporary Halt: To stop printing temporarily, press **PRINT** key while printing.  
To recommence printing, press **PRINT** key again.
- ◆ Cancel Printing: To stop printing temporarily, press **PRINT** key while printing.  
When the printing is halted, press **MENU** key.  
As the menu screen will be displayed, select 1. MONITOR.

# 3. Measurement Mode

## 3.1 How to Measure Average, Max and Min value [Average Mode]

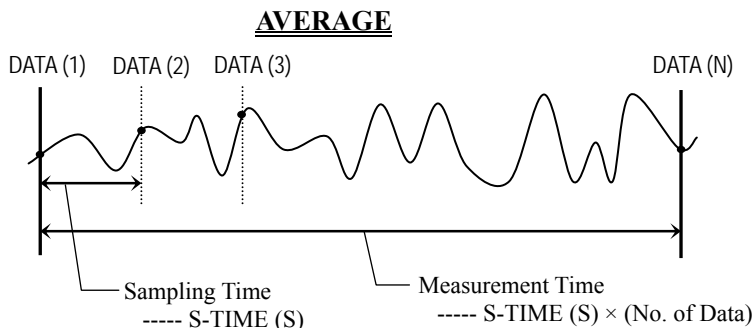

- ◆ Average Value  
 $AVE = \sum DATA(N) / N$
- ◆ Max & Min Values  
 $MAX = DATA(i)$   
 $MIN = DATA(j)$

\* Data is collected every designated sampling time.

Each data (DATA (N)) is not the average value per sampling time but instantaneous value.

Display	Key	Procedure
↓	<b>MENU</b>	(1) Press <b>MENU</b> key.
<div style="border: 1px solid black; padding: 5px;"> <p style="text-align: center;">&lt; MENU &gt;</p> <p>1. MONITOR</p> <p>2. MEASUREMENT</p> <p>3. DATA OUTPUT</p> <p>4. MEMORY CLEAR</p> <p>5. UTILITY</p> </div>	<p>△, ▽</p> <p><b>SET</b></p>	(2) Select 2. <u>MEASUREMENT</u> . Then press <b>SET</b> key.
↓		
<div style="border: 1px solid black; padding: 5px;"> <p style="text-align: center;">&lt; MEASUREMENT &gt;</p> <p>1. AVERAGE</p> <p>2. INTERVAL</p> <p>3. FLOW RATE</p> </div>	<p>△, ▽</p> <p><b>SET</b></p>	(3) Select 1. <u>AVERAGE</u> . Then press <b>SET</b> key.
↓		
<div style="border: 1px solid black; padding: 5px;"> <p style="text-align: center;">&lt; AVE &gt;</p> <p>1. S-TIME (s) 01</p> <p>2. DATA (N) 001</p> <p>3. MEMORY NO</p> <p>4. PRINT NO</p> <p>5. SET OK!</p> </div>	<p>△, ▽</p> <p><b>SET</b></p>	(4) Select the item that you want to change. ➤ For more information on the each item, please refer to the “Measurement Condition” on the next page Then press <b>SET</b> key.
↓		
<div style="border: 1px solid black; padding: 5px;"> <p style="text-align: center;">&lt; AVE &gt;</p> <p>1. S-TIME (s) 01</p> <p>2. DATA (N) 001</p> <p>3. MEMORY NO</p> </div>	<p>△, ▽</p> <p><b>SET</b></p>	(5) The item to be changed will be highlighted. Use △, ▽ keys to change the number. Then press <b>SET</b> key.
↓		
<div style="border: 1px solid black; padding: 5px;"> <p style="text-align: center;">&lt; MENU &gt;</p> <p>1. S-TIME (s) 01</p> <p>2. DATA (N) 001</p> <p>3. MEMORY NO</p> </div>		(6) For the other items, follow likewise the above procedure (4) and (5).

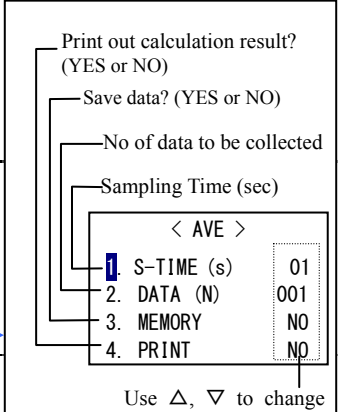

[Measurement Condition]

S-TIME (S):	Set the length of sampling (instantaneous value) time. Configurable sampling time (sec): 1 ~ 6, 10, 12, 15, 20, 30, 40, 50, 60 sec
DATA (N):	Set how many data to be taken every configured sampling time. Configurable number of data: 1 ~ 6, 10, 12, 15, 20, 30, 40, 50, 60, 100, 120, 150, 180
MEMORY:	When <u>YES</u> , data will be stored in the internal memory. For details on memory capacity, refer to P22.
PRINT:	When <u>YES</u> , the calculation result will be output to the printer automatically. When <u>NO</u> , you can still print out the hardcopy of the calculation result by pressing <b>PRINT</b> key after the calculation result is displayed. Refer to P24 for printout samples.

<table border="1"> <tr><td>3. MEMORY</td><td>NO</td></tr> <tr><td>4. PRINT</td><td>NO</td></tr> <tr><td>5. SET OK!</td><td></td></tr> </table>	3. MEMORY	NO	4. PRINT	NO	5. SET OK!		<p>△, ▽ <b>SET</b></p>	<p>(7) After measurement condition is set, select <b>5. SET OK!</b>. Then press <b>SET</b> key.</p>												
3. MEMORY	NO																			
4. PRINT	NO																			
5. SET OK!																				
<p>(a)</p> <table border="1"> <tr><td>&lt;AVE&gt;</td><td>ready</td></tr> <tr><td>T: 00/10</td><td>M: 015</td></tr> <tr><td>N: 000/010</td><td>P: 007</td></tr> <tr><td colspan="2">16.8 m/s</td></tr> <tr><td colspan="2">127 °C</td></tr> </table>	<AVE>	ready	T: 00/10	M: 015	N: 000/010	P: 007	16.8 m/s		127 °C		<p><b>START/STOP</b></p>	<p>(8) <b>ready</b> will be displayed indicating that the instrument is ready to start a measurement. Press <b>START/STOP</b> key to start sampling. ☆To go back to the previous screen (measurement condition setting screen) press <b>△</b> key.</p>								
<AVE>	ready																			
T: 00/10	M: 015																			
N: 000/010	P: 007																			
16.8 m/s																				
127 °C																				
<table border="1"> <tr><td>&lt;AVE&gt;</td><td></td></tr> <tr><td>T: 01/10</td><td>M: 015</td></tr> <tr><td>N: 001/060</td><td>P: 007</td></tr> <tr><td colspan="2">16.8 m/s</td></tr> <tr><td colspan="2">127 °C</td></tr> </table>	<AVE>		T: 01/10	M: 015	N: 001/060	P: 007	16.8 m/s		127 °C		<p>[Start Measuring]</p>	<p>☆To stop measuring halfway through: <b>START/STOP</b> or <b>▽</b> key. - The data collected until the measurement is halted will be calculated.</p>								
<AVE>																				
T: 01/10	M: 015																			
N: 001/060	P: 007																			
16.8 m/s																				
127 °C																				
<table border="1"> <tr><td>&lt;AVE&gt;</td><td></td></tr> <tr><td>T: 10/10</td><td>M: 016</td></tr> <tr><td>N: 060/060</td><td>P: 007</td></tr> <tr><td colspan="2">12.8 m/s</td></tr> <tr><td colspan="2">126 °C</td></tr> </table>	<AVE>		T: 10/10	M: 016	N: 060/060	P: 007	12.8 m/s		126 °C		<p>[Stop Measuring]</p>	<p>☆To cancel measuring (a): Press <b>△</b> key. - It will go back to screen (a) where the instrument is ready to start a measurement.</p>								
<AVE>																				
T: 10/10	M: 016																			
N: 060/060	P: 007																			
12.8 m/s																				
126 °C																				
<table border="1"> <tr><td colspan="2">&lt;AVE RESULT&gt;</td></tr> <tr><td>AVE:</td><td>12.8 m/s</td></tr> <tr><td>MAX:</td><td>15.8 m/s</td></tr> <tr><td>MIN:</td><td>10.8 m/s</td></tr> <tr><td>AVE:</td><td>126 °C</td></tr> <tr><td>MAX:</td><td>129 °C</td></tr> <tr><td>MIN:</td><td>123 °C</td></tr> </table>	<AVE RESULT>		AVE:	12.8 m/s	MAX:	15.8 m/s	MIN:	10.8 m/s	AVE:	126 °C	MAX:	129 °C	MIN:	123 °C	<p>[Calculation Result]</p>	<p>☆To cancel a measurement (b): Press <b>MENU</b> key. - It will go back to the menu screen.</p>				
<AVE RESULT>																				
AVE:	12.8 m/s																			
MAX:	15.8 m/s																			
MIN:	10.8 m/s																			
AVE:	126 °C																			
MAX:	129 °C																			
MIN:	123 °C																			
<p>Printing Example ⇨ P24</p>	<table border="1"> <tr><td>T: 01/10</td><td>S-TIME (S)</td></tr> <tr><td></td><td>setting value (sec)</td></tr> <tr><td></td><td>will be increased every second</td></tr> <tr><td>M: 015</td><td>used memory (shown in %). When it shows 100 (%), there is no memory left.)</td></tr> <tr><td>N: 001/060</td><td>DATA (N)</td></tr> <tr><td></td><td>setting value</td></tr> <tr><td></td><td>will be increased every time data is collected.</td></tr> <tr><td>P: 007</td><td>the page number where the data is stored ⇨ P22</td></tr> <tr><td></td><td>If 3.MEMORY NO is selected, it will not be displayed.</td></tr> </table>	T: 01/10	S-TIME (S)		setting value (sec)		will be increased every second	M: 015	used memory (shown in %). When it shows 100 (%), there is no memory left.)	N: 001/060	DATA (N)		setting value		will be increased every time data is collected.	P: 007	the page number where the data is stored ⇨ P22		If 3.MEMORY NO is selected, it will not be displayed.	<p><b>PRINT</b>: hardcopy of the display screen <b>START/STOP</b> or <b>▽</b>: ready for measuring (a) <b>MENU</b>: menu will be displayed.</p>
T: 01/10	S-TIME (S)																			
	setting value (sec)																			
	will be increased every second																			
M: 015	used memory (shown in %). When it shows 100 (%), there is no memory left.)																			
N: 001/060	DATA (N)																			
	setting value																			
	will be increased every time data is collected.																			
P: 007	the page number where the data is stored ⇨ P22																			
	If 3.MEMORY NO is selected, it will not be displayed.																			

### 3.2 How to Collect Data at Certain Time Intervals [Interval Mode]

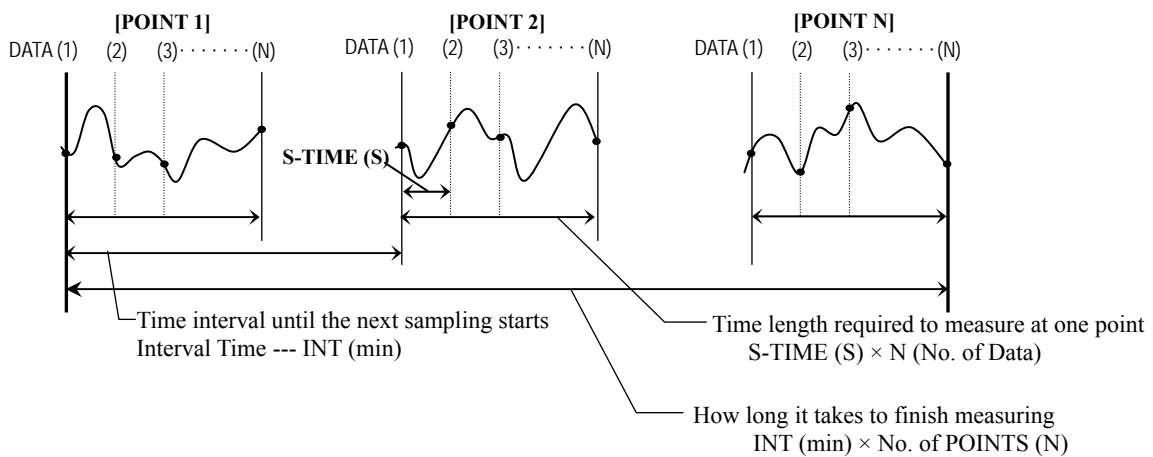

◆ Data at each point is average value.

$$\begin{aligned} \text{POINT 1} \cdots \text{AVE 1} &= \Sigma \text{DATA}(N)/N \\ \text{POINT 2} \cdots \text{AVE 1} &= \Sigma \text{DATA}(N)/N \\ \cdot & \cdot \cdot \\ \cdot & \cdot \cdot \cdot \\ \text{POINT N} \cdots \text{AVE H} &= \Sigma \text{DATA}(N)/N \end{aligned}$$

#### Calculation Result

$$\begin{aligned} \text{AVE} &= (\text{AVE1} + \text{AVE2} + \cdots + \text{AVE N}) / \text{No. of POINT (N)} \\ \text{MAX} &= \text{AVE I}, \text{MIN} = \text{AVE J} \\ \text{AVE1, AVE2, } \cdots \text{ AVE N} & \text{ are stored as a data at each point.} \end{aligned}$$

Display	Key	Procedure
 < MENU > 1. MONITOR 2. MEASUREMENT 3. DATA OUTPUT 4. MEMORY CLEAR 5. UTILITY	MENU	(1) Press MENU key.
 < MEASUREMENT > 1. AVERAGE 2. INTERVAL 3. FLOW RATE	Δ, ▽ SET	(2) Select 2. MEASUREMENT. Then press SET key.
(a)  < INT > 1. S-TIME (S) 01 2. DATA (N) 010 3. INT (min) 060 4. POINTS 024 5. MEMORY YES 6. PRINT YES 7. SET OK! <Measurement Setting Screen>	Δ, ▽ SET  SET	(4) Set the measurement condition in the same manner as when configuring Average Mode measurement (P14).  When the measurement condition is configured, select 7. SET OK!, and press SET key.

- ☆ To select the item to be changed
   
 $\Delta, \nabla \rightarrow \text{SET}$
- ☆ To change setting value and YES/NO.
   
 $\Delta, \nabla \rightarrow \text{SET}$
- ☆ Setting is complete.
   
 $7. \text{SET OK!} \rightarrow \text{SET}$

**[Measurement Condition]**

INT (min): Set how often a measurement to be started.  
 Configurable sampling interval (min):  
 1 ~ 6, 10, 12, 15, 20, 30, 40, 50, 60, 100, 120, 150, 180 min.  
 \* Interval (INT) has to be set longer time than sampling time at each point.

POINTS: Set how many points you want to perform a measurement?  
 Configurable number of points: 1 ~ 999 points

\* For S-TIME(S), DATA(N), MEMORY, PRINT, refer to page 15 describing the average measurement.

<p>(b)</p> <div style="border: 1px solid black; padding: 5px;"> <p>&lt;INT&gt; ready</p> <p>T: 00/10 M:036</p> <p>N: 000/010 P:016</p> <p>16.8 m/s</p> <p>127 °C</p> </div>	<p>START/STOP</p>	<p>(5) <b>ready</b> will be displayed indicating that the instrument is ready to start a measurement.                  Press <b>START/STOP</b> key to start sampling.                  ☆ To go back to the measurement setting screen (a), press <b>△</b> key.</p>
<p>(6-1)</p> <div style="border: 1px solid black; padding: 5px;"> <p>&lt;INT&gt;</p> <p>T: 01/10 M:036</p> <p>N: 001/010 P:016</p> <p>16.8 m/s</p> <p>128 °C</p> </div>	<p>[Start Measuring]</p>	<p>(6)                  (6-1):                  Sampling at one point.</p>
<p>(6-2)</p> <div style="border: 1px solid black; padding: 5px;"> <p>&lt;INT&gt;</p> <p>WAIT 060 min</p> <p>POINTS 001/024</p> <p>12.8 m/s</p> <p>126 °C</p> </div>	<p>[Waiting]</p>	<p>(6-2):                  After a sampling at one point is finished, the instrument will standby for the next sampling. On the screen, the average value for one point will be displayed until the next measurement will start.</p>
<p>(6-3)</p> <div style="border: 1px solid black; padding: 5px;"> <p>&lt;INT&gt;</p> <p>WAIT 001 min</p> <p>POINTS 001/024</p> <p>16.8 m/s</p> <p>126 °C</p> </div>		<p>(6-3):                  One minute is left before the next measurement starts                  One minute later, the screen will become screen (6-1) and a measurement will start.</p>
		<p>(7) Repeat the above procedure from (6-1) to (6-3) for the configured number of points.</p> <p>☆To stop measuring halfway through: <b>START/STOP</b> or <b>▽</b> key.                  - The data collected until the measurement is halted will be calculated.</p> <p>☆To stop measuring (1): <b>△</b> key.                  - It will go back to the screen (b) where the instrument is ready to start a measurement.</p> <p>☆To cancel a measurement (2): <b>MENU</b> key.                  - It will go back to the menu screen.</p>
	<p>[Stop Measuring]</p>	
<div style="border: 1px solid black; padding: 5px;"> <p>&lt;INT RESULT&gt;</p> <p>AVE: 19.8 m/s</p> <p>MAX: 21.6 m/s</p> <p>MIN : 18.5 m/s</p> <p>AVE: 126 °C</p> <p>MAX: 129 °C</p> <p>MIN : 123 °C</p> </div> <p>Printing Example                  ⇐ P24</p>	<p>Calculation Result</p> <p>Printing Example                  ⇐ P24</p>	<p>Data at each point is an average data. Average, maximum and minimum of the average data at each point will be displayed.</p> <p><b>PRINT</b>: hardcopy of the display screen</p> <p><b>START/STOP</b> or <b>▽</b>: ready for measuring (screen b)</p> <p><b>MENU</b>: menu will be displayed</p>

As for “ready” display, refer to page 16 describing average measurement.

WAIT 060 min:  
 waiting time remaining time length before the next measurement starts (min)

POINTS 001/024: point  
 Total set No. of measurement trials  
 Current sampling trial No.

### 3.3 How to Measure Flow Rate in the Duct [Flow Rate Mode]

#### FLOW RATE

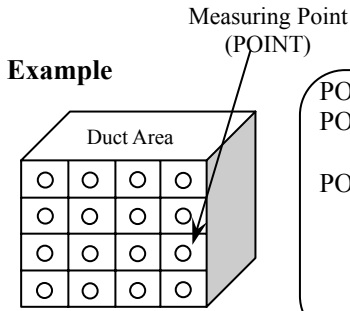

◆ **Measurement**

POINT 1 --- AVE 1 =  $\Sigma \text{DATA (N)/N}$

POINT 2 --- AVE 2 =  $\Sigma \text{DATA (N)/N}$

POINT M --- AVE M =  $\Sigma \text{DATA (N)/N}$

Average Air Velocity

$$U = \frac{(\text{AVE1} + \text{AVE2} + \dots + \text{AVE N})}{\text{No. of Points (M)}}$$

- \* To start a measurement at each point: **START/STOP** key
- \* For detailed information on measuring at each point, refer to **3.2 How to Collect Data at Certain Time Intervals [Interval Mode]** (P16).

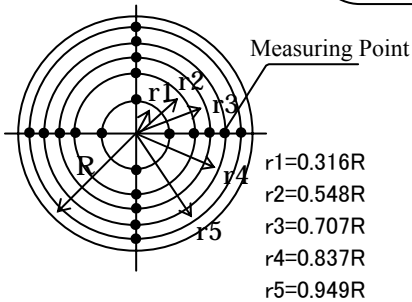

◆ **Calculation result**

Air Volume (F) = Average Air Velocity (U) × Cross Section (AREA)  
indicated in m<sup>3</sup>/hour and m<sup>3</sup>/min

Display	Key	Procedure
↓	<b>MENU</b>	(1) Press <b>MENU</b> key.
<div style="border: 1px solid black; padding: 5px;"> <p style="text-align: center;">&lt; MENU &gt;</p> <p>1. MONITOR</p> <p>2. MEASUREMENT</p> <p>3. DATA OUTPUT</p> <p>4. MEMORY CLEAR</p> <p>5. UTILITY</p> </div>	▲, ▼ <b>SET</b>	(2) Select <u>2. MEASUREMENT</u> . Then press <b>SET</b> key.
↓		
<div style="border: 1px solid black; padding: 5px;"> <p style="text-align: center;">&lt; MEASUREMENT &gt;</p> <p>1. AVERAGE</p> <p>2. INTERVAL</p> <p>3. FLOW RATE</p> </div>	▲, ▼ <b>SET</b>	(3) Select <u>3. FLOW RATE</u> . Then press <b>SET</b> key.
↓		
<div style="border: 1px solid black; padding: 5px;"> <p>(a) &lt; FLOW &gt;</p> <p>1. S-TIME (S) 01</p> <p>2. DATA (N) 010</p> <p>3. POINTS 016</p> <p>4. AREA (m<sup>2</sup>) 0.100</p> <p>5. MEMORY YES</p> <p>6. PRINT YES</p> <p>7. SET OK!</p> <p style="text-align: center;">&lt;Measurement Setting Screen&gt;</p> </div>	▲, ▼ <b>SET</b>	(4) Set the measurement condition in the same manner as when configuring Average Mode (P14).
	<b>SET</b>	When the measurement condition is configured, select <u>7. SET OK!</u> , and press <b>SET</b> key.

☆ To select the item to be changed     ▲, ▼ → **SET**

☆ To change setting value and YES/NO.     ▲, ▼ → **SET**

☆ Setting is complete.     7. SET OK! → **SET**



[Measurement Condition]

**POINTS:** Set how many points to perform a measurement to find average air velocity?  
Configurable number of partitions: 1 ~ 100 points

**AREA(m<sup>2</sup>):** Duct's cross section area (Effective Area)  
Configurable area size: 0.001 ~ 9.999m<sup>2</sup>  
\* For S-TIME(S), DATA(N), MEMORY, PRINT, refer to page 15 describing the average measurement.

Display	Key	Procedure
<p>(b)</p>	<p>[START/STOP]</p>	<p>(5) <b>ready</b> will be displayed indicating that the instrument is ready to start a measurement. Press [START/STOP] key to start sampling. To go back to the measurement setting screen (a), press [△] key.</p>
<p>(6-1)</p>	<p>[Start Measuring]</p>	<p>(6) (6-1) Measuring at one point. (6-2) After measuring at one point is finished, move the probe to the next point and press [START/STOP] key. Then measuring at the next point will start. ★ Repeat the above procedure (6-1) and (6-2) for the configured number of sampling points.</p>
	<p>[START/STOP]</p>	<p>NEXT START! --- waiting for sampling at the next point. POINTS 001/016 --- No. of Points                   --- setting value                   --- No. of points where sampling has been done</p>
	<p>[START/STOP]</p>	<p>To stop measuring halfway through: [▽] key. - While sampling at a point, the sampling at the point will be finished. - When the instrument is waiting for the next sampling, the data taken before the measurement stopped will be calculated. To stop a measurement (1) : [△] key - Will go back to the measurement standby mode (screen (b)) To stop a measurement (2) : [MENU] key - Will go back to the menu screen.</p>
	<p>[Calculation Result]</p>	<p>[PRINT]: hardcopy of the display screen [START/STOP] or [▽]: ready for measuring (to continue sampling) [MENU]: menu will be displayed.</p>

### 3.4 Program Set

#### 3.4.1 How to Pre-set Measurement Mode

- If a measurement mode is preset, the instrument will enter the measurement standby when you turn it on. To start a measurement, you only need to press **START/STOP** key.

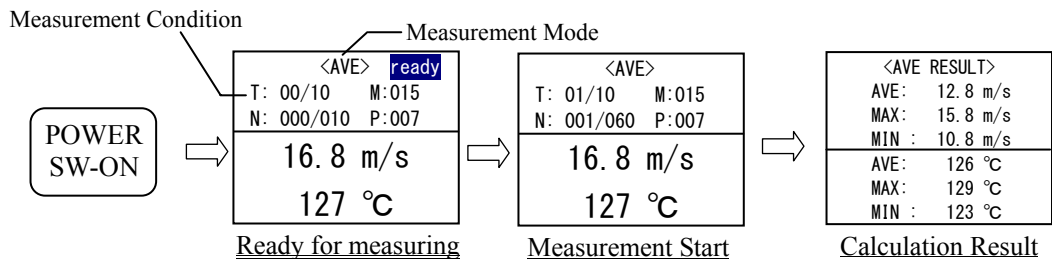

Display	Key	Procedure
<p style="text-align: center;">↓</p> <div style="border: 1px solid black; padding: 5px;"> <p style="text-align: center;">&lt; MENU &gt;</p> <p>1. MONITOR 2. MEASUREMENT 3. DATA OUTPUT 4. MEMORY CLEAR 5. UTILITY</p> </div>	<p style="border: 1px solid black; padding: 2px;">MENU</p>	(1) Press <b>MENU</b> key.
<p style="text-align: center;">↓</p> <div style="border: 1px solid black; padding: 5px;"> <p style="text-align: center;">&lt; UTILITY &gt;</p> <p>1. CALENDAR 2. ANALOG OUTPUT 3. PROGRAM SET 4. RS-232C</p> </div>	<p style="border: 1px solid black; padding: 2px;">↑, ↓</p> <p style="border: 1px solid black; padding: 2px;">SET</p>	(2) Select <u>5. UTILITY</u> . Then press <b>SET</b> key.
<p style="text-align: center;">↓</p> <div style="border: 1px solid black; padding: 5px;"> <p style="text-align: center;">&lt; PROGRAM SET &gt;</p> <p>1. OFF 2. AVERAGE 3. INTERVAL 4. FLOW RATE</p> </div>	<p style="border: 1px solid black; padding: 2px;">↑, ↓</p> <p style="border: 1px solid black; padding: 2px;">SET</p>	(3) Select <u>3. PROGRAM SET</u> . Then press <b>SET</b> key.
<p style="text-align: center;">↓</p> <div style="border: 1px solid black; padding: 5px;"> <p style="text-align: center;">&lt; PROGRAM SET &gt;</p> <p>1. OFF 2. AVERAGE 3. INTERVAL 4. FLOW RATE</p> </div>	<p style="border: 1px solid black; padding: 2px;">↑, ↓</p> <p style="border: 1px solid black; padding: 2px;">SET</p>	(4) Select a measurement mode to be used. Then press <b>SET</b> key.
<p style="text-align: center;">↓</p> <div style="border: 1px solid black; padding: 5px;"> <p style="text-align: center;">&lt; PROGRAM SET &gt;</p> <p>1. OFF 2. AVERAGE 3. INTERVAL 4. FLOW RATE</p> </div>		(5) The cursor will move to the selected calculation mode. Then, the measurement condition setting screen will be displayed automatically.
<p style="text-align: center;">↓</p> <div style="border: 1px solid black; padding: 5px;"> <p style="text-align: center;">&lt; AVE &gt;</p> <p>1. S-TIME (s) 01 2. DATA (N) 10 3. MEMORY YES 4. PRINT YES 5. SET OK!</p> <p style="text-align: center;">&lt;Measurement Setting Screen&gt;</p> </div>	<p style="border: 1px solid black; padding: 2px;">↑, ↓</p> <p style="border: 1px solid black; padding: 2px;">SET</p>	(6) Configure measurement setting. Then move the cursor to <u>5. SET</u> <b>OK</b> , and press <b>SET</b> key. The set measurement mode will be applied even when you turn off the instrument. If you turn the power on again, it will enter the measurement standby mode.

OFF: No Program Set  
AVERAGE: Average Value Measurement  
INTERVAL: Intermittent Operation Measurement  
FLOW RATE: Air Flow Measurement

### 3.4.2 Other Measurement Mode Cannot be Used

- When a measurement mode is set, only the configured mode can be used. Even if you select 2. MEASUREMENT on the menu screen, a screen that allows you to select a measurement mode will not display. In stead you will see the screen that allows you to configure the measurement setting for the set measurement mode. In order to use other measurement mode, you need to deactivate the current selected mode.

[Example] When Flow Rate mode is set;

Even if you select 2. MEASUREMENT, ..... The below screen will not be displayed.

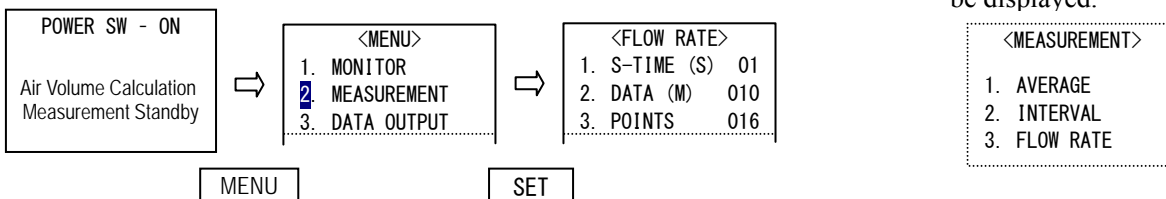

### 3.4.3 How to Deactivate Pre-set Measurement Mode

- In the same manner as when you configure program setting, display the <PROGRAM SET> screen. When it is displayed, select 1. OFF.

Display	Key	Procedure
		(1) Select <u>1. OFF</u> . Then press <b>SET</b> key.
		(2) <u>1. OFF</u> will be highlighted. Then, the menu screen will be displayed automatically.
		(3) Select <u>2. MEASUREMENT</u> to perform a measurement.

### 3.5 Memory Capacity

- Measurement data is stored per page. On top of the each page the measurement condition is stored. Therefore, the more pages you save, the less data you can store.

Below describes how to figure out how many pages of data can be stored when you know how many data you want to take.

**Measurement data is stored per page.**

**Make sure to check in which page the data is stored.**

**A measurement data consists of air velocity data and air temperature data.**

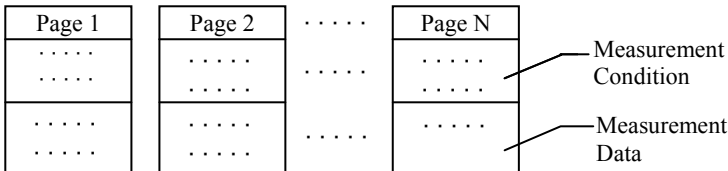

Number of Bytes Used per Page		
(1) Measurement Starting Date (08. 7. 1 10:40) -----	12 bytes	
(2) Measurement Item (air velocity, air temp VT) -----	2 bytes	
(3) Measurement -----	2 bytes	
(Average: AVE, Interval: INT, Air Flow: FLW)		--- Measurement Condition
(4) Sampling Time (S-TIME(S)) -----	2 bytes	Total: 24 bytes
(5) No. of Data (DATA (N)) -----	2 bytes	
(6) No. of Measurement Points (POINTS) -----	2 bytes	
(7) Measurement Interval INT (min) or Duct Area AREA (m <sup>2</sup> ) -----	2 bytes	
(8) Air Velocity Data and Air Temperature Data -----	4 bytes × No. of data	

How to Figure Out How Many Pages Can Be Saved							
<p><u>Internal Memory</u> --- Memory Capacity 4770 bytes</p> $P = \frac{4770}{(24 + 4 \times N)}$ <p style="margin-left: 20px;">                     P --- Memory Capacity                      4770 --- Memory Capacity                      (24 + 4 × N) --- Measurement Condition                      24 --- Measurement Condition                      4 × N --- Data                 </p>	<p>1 page ... (24+4×N) bytes</p> <table border="1" style="width: 100%; border-collapse: collapse;"> <tr> <td style="padding: 2px;">Average Value Measurement:</td> <td style="padding: 2px;">Data Volume (DATA (N))</td> </tr> <tr> <td style="padding: 2px;">Intermittent Operation:</td> <td style="padding: 2px;">Number of Points (POINTS)</td> </tr> <tr> <td style="padding: 2px;">Air Flow Measurement:</td> <td style="padding: 2px;">Number of Points (POINTS)</td> </tr> </table>	Average Value Measurement:	Data Volume (DATA (N))	Intermittent Operation:	Number of Points (POINTS)	Air Flow Measurement:	Number of Points (POINTS)
Average Value Measurement:	Data Volume (DATA (N))						
Intermittent Operation:	Number of Points (POINTS)						
Air Flow Measurement:	Number of Points (POINTS)						
<p>[Example] When N is 10, P is 74 according to the above formula.</p> <p>This means that when the number of data is 10, you can perform a measurement for 74 times (pages).</p>							

### 3.5.1 “Memory Over” Display

- When “SET OK!” is selected on the measurement setting screen, the instrument determines if there is enough memory capacity. If there is not enough memory capacity left, “MEMORY OVER” will be displayed.

Ave. Value Measurement	Intermittent Operation	Air Flow Measurement	Explanation
<div style="border: 1px solid black; padding: 5px; margin-bottom: 5px;"> <p style="text-align: center;">&lt; AVE &gt;</p> <p>1. S-TIME (s) 01</p> <p>2. DATA (N) 100</p> <p>3. MEMORY YES</p> <p>4. PRINT NO</p> <p>5. SET OK!</p> </div> <div style="border: 1px solid black; padding: 5px; margin-bottom: 5px;"> <p style="text-align: center;">&lt; AVE &gt;</p> <p>1. S-TIME (s) 01</p> <p>2. DATA (N) 100</p> <p>3. MEMORY YES</p> <p>4. PRINT NO</p> <p style="text-align: center;">MEMORY OVER</p> </div> <div style="border: 1px solid black; padding: 5px;"> <p style="text-align: center;">&lt; AVE &gt;</p> <p>1. S-TIME (s) 01</p> <p>2. DATA (N) 100</p> <p>3. MEMORY YES</p> <p>4. PRINT NO</p> <p>5. SET OK!</p> </div>	<div style="border: 1px solid black; padding: 5px; margin-bottom: 5px;"> <p style="text-align: center;">&lt; INT &gt;</p> <p>1. S-TIME (S) 01</p> <p>2. DATA (N) 010</p> <p>3. INT (min) 060</p> <p>4. POINTS 024</p> <p>5. MEMORY YES</p> <p>6. PRINT NO</p> <p>7. SET OK!</p> </div> <div style="border: 1px solid black; padding: 5px; margin-bottom: 5px;"> <p style="text-align: center;">&lt; INT &gt;</p> <p>1. S-TIME (S) 01</p> <p>2. DATA (N) 010</p> <p>3. INT (min) 060</p> <p>4. POINTS 024</p> <p>5. MEMORY YES</p> <p>6. PRINT NO</p> <p style="text-align: center;">MEMORY OVER</p> </div> <div style="border: 1px solid black; padding: 5px;"> <p style="text-align: center;">&lt; INT &gt;</p> <p>1. S-TIME (S) 01</p> <p>2. DATA (N) 010</p> <p>3. INT (min) 060</p> <p>4. POINTS 024</p> <p>5. MEMORY YES</p> <p>6. PRINT NO</p> <p>7. SET OK!</p> </div>	<div style="border: 1px solid black; padding: 5px; margin-bottom: 5px;"> <p style="text-align: center;">&lt; FLOW &gt;</p> <p>1. S-TIME (S) 01</p> <p>2. DATA (N) 010</p> <p>3. POINTS 060</p> <p>4. AREA (m2) 1.000</p> <p>5. MEMORY YES</p> <p>6. PRINT NO</p> <p>7. SET OK!</p> </div> <div style="border: 1px solid black; padding: 5px; margin-bottom: 5px;"> <p style="text-align: center;">&lt; FLOW &gt;</p> <p>1. S-TIME (S) 01</p> <p>2. DATA (N) 010</p> <p>3. POINTS 060</p> <p>4. AREA (m2) 1.000</p> <p>5. MEMORY YES</p> <p>6. PRINT NO</p> <p style="text-align: center;">MEMORY OVER</p> </div> <div style="border: 1px solid black; padding: 5px;"> <p style="text-align: center;">&lt; FLOW &gt;</p> <p>1. S-TIME (S) 01</p> <p>2. DATA (N) 010</p> <p>3. POINTS 060</p> <p>4. AREA (m2) 1.000</p> <p>5. MEMORY YES</p> <p>6. PRINT NO</p> <p>7. SET OK!</p> </div>	<p>After configuring each measurement condition, select SET OK!. Then press SET.</p> <p>“MEMORY OVER” display</p> <p>The cursor will move to DATA (N) or POINTS automatically. Change the setting or delete the data (⇐P28)</p>

- When repeating a measurement by using START/STOP key or a measurement mode is set, the instrument determines if there is enough memory left on the measurement stand-by screen.

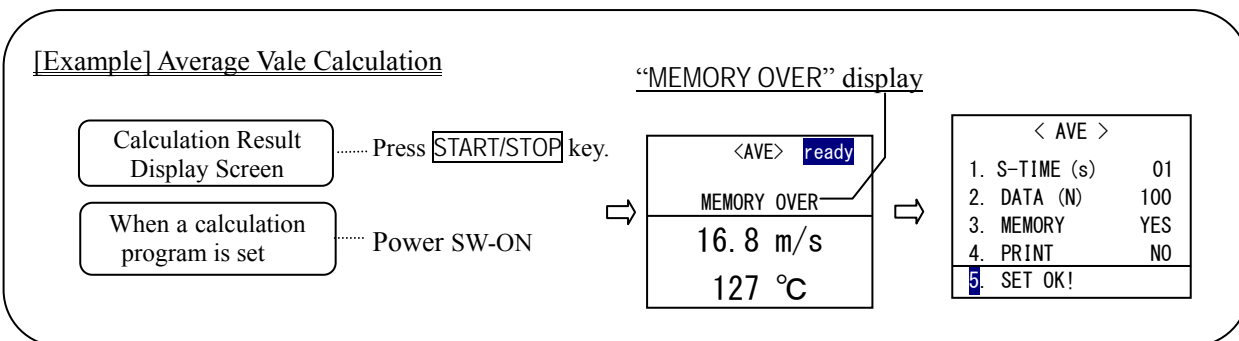

### 3.6 Printing Example – Automatic Printing and Hardcopy of Calculation Result

#### 3.6.1 Automatic Printing Example

Average Mode	Interval Mode	Air Flow Mode	
2008.07.01 10:26	2008.07.01 10:26	2008.07.01 10:26	Measurement starting date & time
<AVE>	<INT>	<FLOW>	Measurement Mode
S-TIME (S) 01 DATA (N) 010 MEMORY P001	S-TIME (S) 01 DATA (N) 010 INT (min) 060 POINTS 024 MEMORY P001	S-TIME (S) 01 DATA (N) 010 POINTS 024 AREA (m2) 0.100 MEMORY P001	Measurement Condition
VELOCITY	VELOCITY	FLOW RATE	Page number where the measurement data is stored When data is not stored, "NONE" is indicated here.
AVE: 2.58 m/s MAX: 3.73 m/s MIN: 1.69 m/s	AVE: 2.58 m/s MAX: 3.73 m/s MIN: 1.69 m/s	15.240 m3/min 914.40 m3/hour	
TEMPERATURE	TEMPERATURE	VELOCITY	Calculation Result
AVE: 126 °C MAX: 129 °C MIN: 123 °C	AVE: 126 °C MAX: 129 °C MIN: 123 °C	2.54 m/s	
		TEMPERATURE	
		126 °C	

#### 3.6.2 Hardcopy Example

Ave. Value Measurement	Intermittent Operation	Air Flow Measurement																				
<table border="1"> <tr><td>&lt;RESULT&gt;</td></tr> <tr><td>AVE: 2.58 m/s</td></tr> <tr><td>MAX: 3.73 m/s</td></tr> <tr><td>MIN: 1.69 m/s</td></tr> <tr><td>AVE: 126°C</td></tr> <tr><td>MAX: 129°C</td></tr> <tr><td>MIN: 123°C</td></tr> </table>	<RESULT>	AVE: 2.58 m/s	MAX: 3.73 m/s	MIN: 1.69 m/s	AVE: 126°C	MAX: 129°C	MIN: 123°C	<table border="1"> <tr><td>&lt;RESULT&gt;</td></tr> <tr><td>AVE: 2.58 m/s</td></tr> <tr><td>MAX: 3.73 m/s</td></tr> <tr><td>MIN: 1.69 m/s</td></tr> <tr><td>AVE: 126°C</td></tr> <tr><td>MAX: 129°C</td></tr> <tr><td>MIN: 123°C</td></tr> </table>	<RESULT>	AVE: 2.58 m/s	MAX: 3.73 m/s	MIN: 1.69 m/s	AVE: 126°C	MAX: 129°C	MIN: 123°C	<table border="1"> <tr><td>&lt;RESULT&gt;</td></tr> <tr><td>15.240 m3/min</td></tr> <tr><td>914.40 m3/hour</td></tr> <tr><td>VEL 2.54 m/s</td></tr> <tr><td>TEMP 126 °C</td></tr> </table>	<RESULT>	15.240 m3/min	914.40 m3/hour	VEL 2.54 m/s	TEMP 126 °C	* In the hardcopy of the screen after calculation result is displayed, date, time and measurement condition will not be printed.
<RESULT>																						
AVE: 2.58 m/s																						
MAX: 3.73 m/s																						
MIN: 1.69 m/s																						
AVE: 126°C																						
MAX: 129°C																						
MIN: 123°C																						
<RESULT>																						
AVE: 2.58 m/s																						
MAX: 3.73 m/s																						
MIN: 1.69 m/s																						
AVE: 126°C																						
MAX: 129°C																						
MIN: 123°C																						
<RESULT>																						
15.240 m3/min																						
914.40 m3/hour																						
VEL 2.54 m/s																						
TEMP 126 °C																						

## 4. How to Redisplay, Print and Delete Stored Data

### 4.1 How to Redisplay Data

You can re-display the stored calculation result.

However, each memory data cannot be displayed on the instrument's display. You need to either output to the printer or transfer data to the computer via digital output (RS-232C)



Display	Key	Procedure
↓	<b>MENU</b>	(1) Press <b>MENU</b> key.
<div style="border: 1px solid black; padding: 5px;"> <p style="text-align: center;">&lt; MENU &gt;</p> <p>1. MONITOR 2. MEASUREMENT 3. DATA OUTPUT 4. MEMORY CLEAR 5. UTILITY</p> </div>	<p style="text-align: center;">↑, ↓ <b>SET</b></p>	(2) Select <u>3.DATA OUTPUT</u> . Then press <b>SET</b> key.
↓		
<div style="border: 1px solid black; padding: 5px;"> <p style="text-align: center;">&lt; DATA OUTPUT &gt;</p> <p>1. DISPLAY 2. PRINTER 3. COMPUTER</p> </div>	<p style="text-align: center;">↑, ↓ <b>SET</b></p>	(3) Select <u>1.DISPLAY</u> . Then press <b>SET</b> key.
↓		
<p>a)</p> <div style="border: 1px solid black; padding: 5px;"> <p style="text-align: center;"><b>MEMORY</b> <b>P: 001</b></p> <p>AVERAGE [VT] ' 08.07.01 10:26</p> <p style="text-align: center;">&lt;Page Setting Screen&gt;</p> </div>	<p style="text-align: center;">↑, ↓ <b>SET</b></p>	(4) Select the page to be output. Then press <b>SET</b> key.
↓		
<div style="border: 1px solid black; padding: 5px;"> <p style="text-align: center;">&lt; RESULT &gt;</p> <p>AVE: 12.5 m/s MAX: 13.8 m/s MIN: 11.6 m/s</p> <hr/> <p>AVE: 126 °C MAX: 129 °C MIN: 123 °C</p> </div>	[Calculation Result]	<div style="border: 1px solid black; padding: 5px; margin-top: 10px;"> <p style="text-align: center;"><b>MEMORY</b> <b>P: 001</b></p> <p>AVERAGE [VT] ' 08.07.01 10:26</p> </div> <p>Memory page number: P: 001 Measurement mode: AVERAGE [VT] Measurement data&amp; time: ' 08.07.01 10:26 Measurement item VT: velocity &amp; temp.</p>
<p><b>START/STOP</b> or <b>↓</b>: Page setting screen (a)</p> <p>MENU: menu display</p>		

If data is not stored, "data not found! MODE PAGE" will be displayed and go back to the menu screen.

### 4.2 How to Output Data to Printer



#### 4.2.1 Procedure for outputting data to a printer

Display	Key	Procedure
↓	<b>MENU</b>	(1) Press <b>MENU</b> key.
<div style="border: 1px solid black; padding: 5px;"> <p style="text-align: center;">&lt; MENU &gt;</p> <p>1. MONITOR 2. MEASUREMENT 3. DATA OUTPUT 4. MEMORY CLEAR 5. UTILITY</p> </div>	▲, ▼ <b>SET</b>	(2) Select <u>3.DATA OUTPUT</u> . Then press <b>SET</b> key.
↓		
<div style="border: 1px solid black; padding: 5px;"> <p style="text-align: center;">&lt; DATA OUTPUT &gt;</p> <p>1. DISPLAY 2. PRINTER 3. COMPUTER</p> </div>	▲, ▼ <b>SET</b>	(3) Select <u>2.PRINTER</u> . Then press <b>SET</b> key.
↓		
<div style="border: 1px solid black; padding: 5px;"> <p style="text-align: center;"><b>MEMORY</b></p> <p style="text-align: center;">P:001~P:007</p> <p>1. START P:001 2. END P:001 3. SET OK!</p> </div>	▲, ▼ <b>SET</b>	(4) Select <u>1.START P:001</u> . Then press <b>SET</b> key.
↓		
<div style="border: 1px solid black; padding: 5px;"> <p>1. <b>START P:005</b> 2. END P:001 3. SET OK!</p> </div>	▲, ▼ <b>SET</b>	(5) <u>1.START P:001</u> will be highlighted. Specify the first page to be printed. Then press <b>SET</b> key.
↓		
<div style="border: 1px solid black; padding: 5px;"> <p>1. START P:005 2. <b>END P:005</b> 3. SET OK!</p> </div>	<b>SET</b>	(6) Select <u>2.END P:005</u> . Then press <b>SET</b> key.
↓		
<div style="border: 1px solid black; padding: 5px;"> <p>1. START P:005 2. <b>END P:007</b> 3. SET OK!</p> </div>	▲, ▼	(7) <u>2.END P:005</u> will be highlighted.. Specify the last page to be printed. Then press <b>SET</b> key.

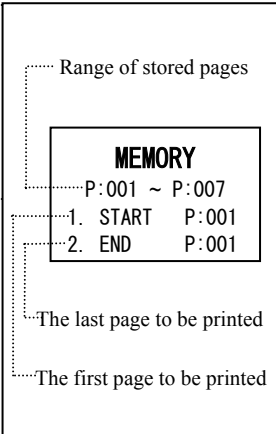



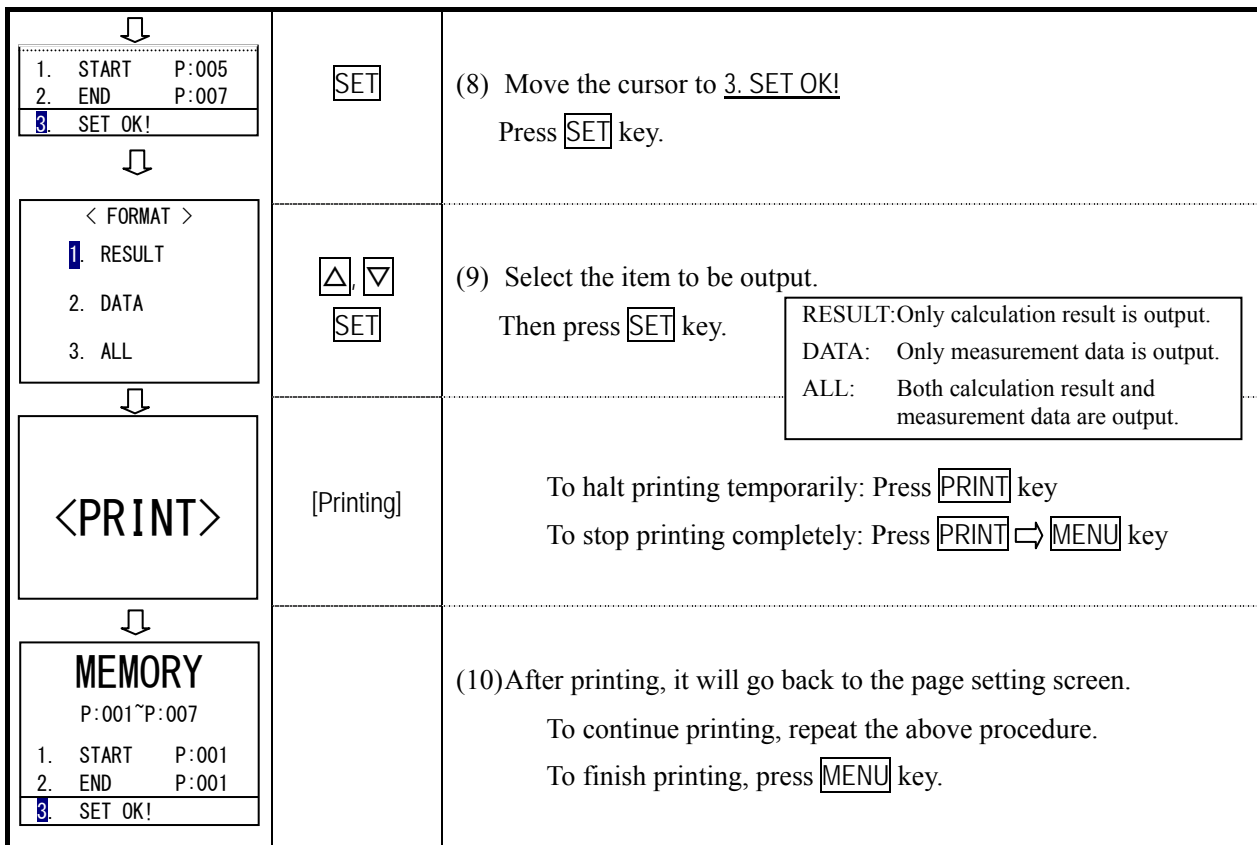

4.2.2 Printing Example

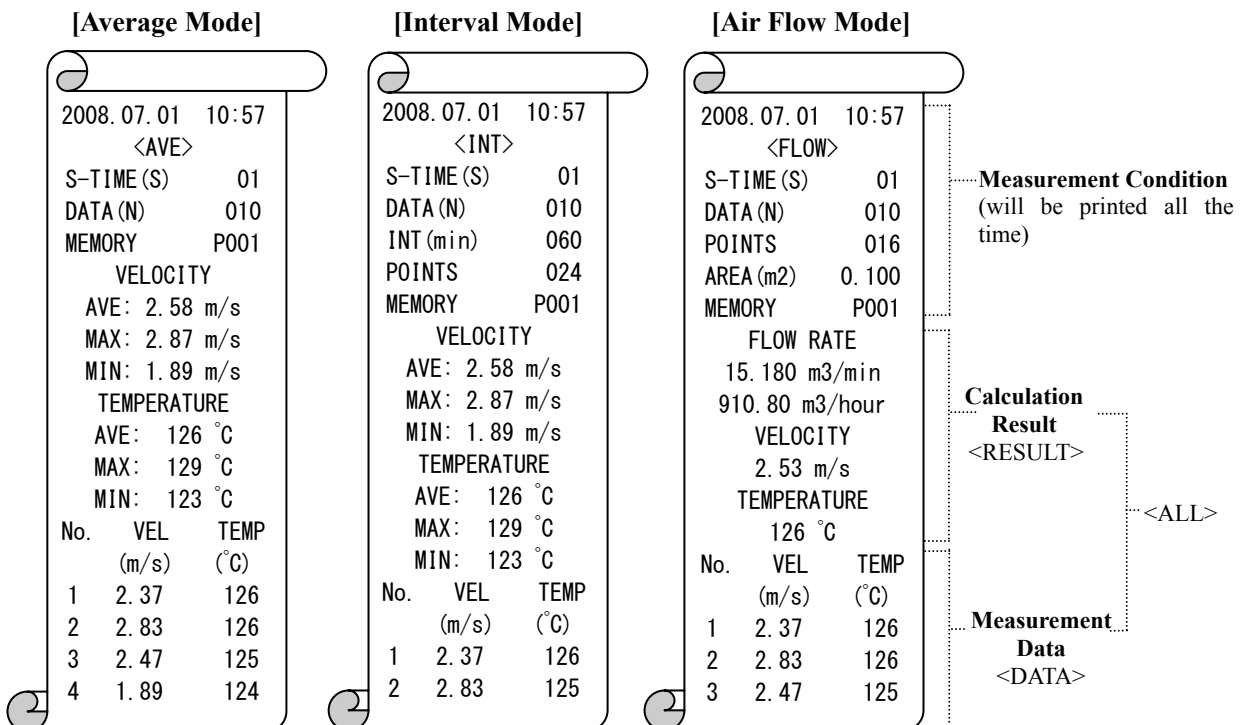

### 4.3 Deleting Memory Data

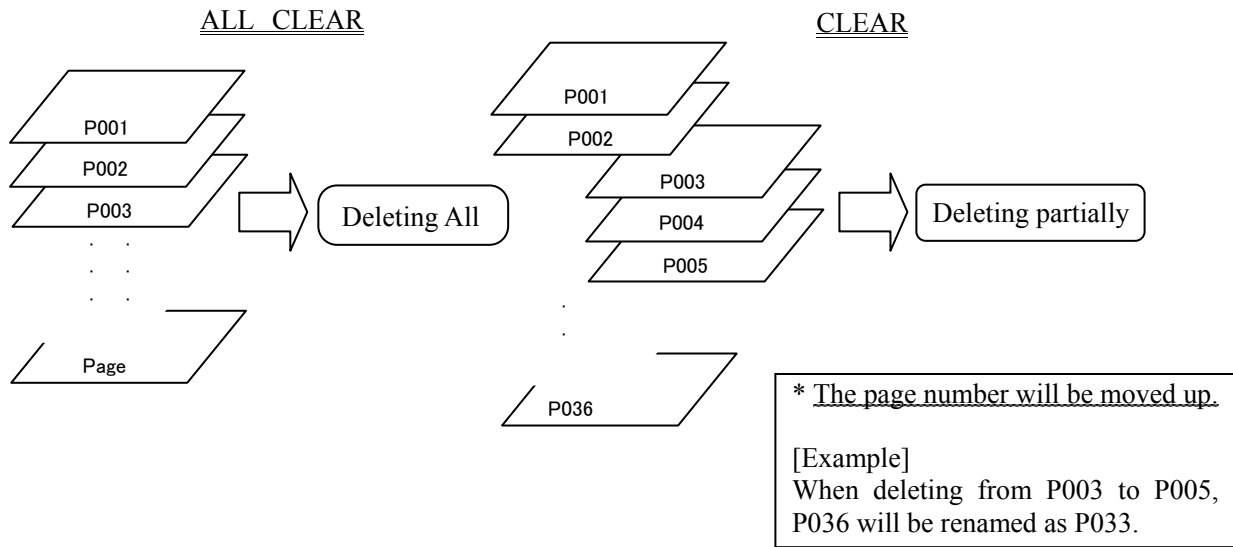

#### 4.3.1 Deleting All

Display	Key	Procedure
↓	<b>MENU</b>	(1) Press <b>MENU</b> key.
<div style="border: 1px solid black; padding: 5px; margin-bottom: 5px;">                     &lt; MENU &gt;                      1. MONITOR                      2. MEASUREMENT                      3. DATA OUTPUT                      4. MEMORY CLEAR                      5. UTILITY                 </div> ↓	▲, ▼ <b>SET</b>	(2) Select <u>4. MEMORY CLEAR</u> . Then press <b>SET</b> key.
<div style="border: 1px solid black; padding: 5px; margin-bottom: 5px;">                     &lt; MEMORY CLEAR &gt;                      1. ALL CLEAR                      2. CLEAR                 </div> ↓	▲, ▼ <b>SET</b>	(3) Select <u>1. ALL CLEAR</u> . Then press <b>SET</b> key.
<div style="border: 1px solid black; padding: 5px; margin-bottom: 5px;"> <b>MEMORY</b>                      ALL CLEAR OK?                      1. NO                      2. YES                 </div> ↓	▲, ▼ <b>SET</b>	(4) Select <u>2. YES</u> . Then press <b>SET</b> key.
<div style="border: 1px solid black; padding: 5px;">                     &lt; MENU &gt;                      1. MONITOR                      2. MEASUREMENT                      3. DATA OUTPUT                      4. MEMORY CLEAR                      5. UTILITY                 </div>		★ When all data is deleted, it will go back to the menu screen.

4.3.2 Deleting Selected Pages Only

Display	Key	Procedure
↓	<b>MENU</b>	(1) Press <b>MENU</b> key.
<div style="border: 1px solid black; padding: 5px;"> <p style="text-align: center;">&lt; MENU &gt;</p> <p>1. MONITOR 2. MEASUREMENT 3. DATA OUTPUT 4. MEMORY CLEAR 5. UTILITY</p> </div>	<p style="text-align: center;">↑, ↓</p> <p style="text-align: center;"><b>SET</b></p>	(2) Select 4. <u>MEMORY CLEAR</u> . Then press <b>SET</b> key.
↓		
<div style="border: 1px solid black; padding: 5px;"> <p style="text-align: center;">&lt; MEMORY CLEAR &gt;</p> <p>1. ALL CLEAR 2. CLEAR</p> </div>	<p style="text-align: center;">↑, ↓</p> <p style="text-align: center;"><b>SET</b></p>	(3) Select 2. <u>CLEAR</u> . Then press <b>SET</b> key.
↓		
<div style="border: 1px solid black; padding: 5px;"> <p style="text-align: center;"><b>MEMORY</b></p> <p style="text-align: center;">P: 001 ~ P: 025</p> <p>1. START P: 001 2. END P: 001 3. SET OK!</p> </div>	<p style="text-align: center;">↑, ↓</p> <p style="text-align: center;"><b>SET</b></p>	(4) Select 1. <u>START P: 001</u> . Then press <b>SET</b> key.
↓		
<div style="border: 1px solid black; padding: 5px;"> <p>1. <b>START P: 001</b> 2. END P: 001 3. SET OK!</p> </div>	<p style="text-align: center;">↑, ↓</p> <p style="text-align: center;"><b>SET</b></p>	(5) Specify the first page to be deleted. Then press <b>SET</b> key.
↓		
<div style="border: 1px solid black; padding: 5px;"> <p>1. START P: 003 2. <b>END P: 003</b> 3. SET OK!</p> </div>	<p style="text-align: center;"><b>SET</b></p>	(6) Move to 2. <u>END P: 003</u> . Then press <b>SET</b> key.
↓		
<div style="border: 1px solid black; padding: 5px;"> <p>1. START P: 003 2. <b>END P: 003</b> 3. SET OK!</p> </div>	<p style="text-align: center;">↑, ↓</p> <p style="text-align: center;"><b>SET</b></p>	(7) Specify the last page to be deleted. Then press <b>SET</b> key.
↓		
<div style="border: 1px solid black; padding: 5px;"> <p>1. START P: 003 2. END P: 005 3. <b>SET OK!</b></p> </div>	<p style="text-align: center;"><b>SET</b></p>	(8) <b><u>Confirm the range of the pages to be deleted.</u></b> If it is OK, press <b>SET</b> key.
↓		
<div style="border: 1px solid black; padding: 5px;"> <p style="text-align: center;">&lt; MENU &gt;</p> <p>1. MONITOR 2. MEASUREMENT 3. DATA OUTPUT 4. MEMORY CLEAR 5. UTILITY</p> </div>		(9) The selected pages are deleted and it will go back to the menu screen.  * <u>The page number will be moved up.</u>

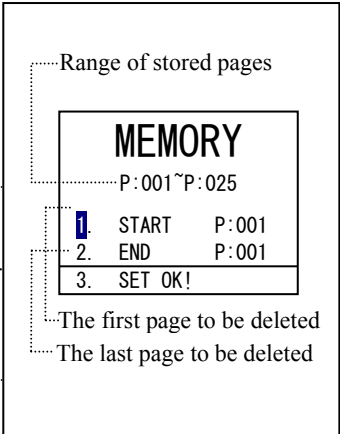

If any data is not stored, "data not found! NONE PAGE" will be displayed and it will go back to the menu screen.

# 5. Data Output

## 5.1 Analog Output

◆ Output on the measurement screen ----- ★ To be output every 0.25 second

Initial Screen: Except when the screen is on hold  
 Measurement Mode: Except when the calculation result is displayed or the instrument is waiting for the next sampling

- ★ Output Voltage: DC0 ~ 1V
- ★ Output Impedance: 47Ω

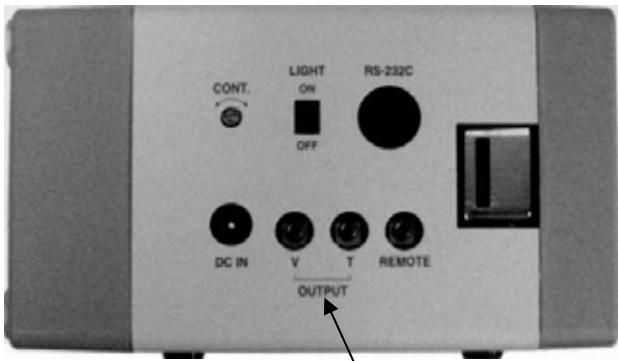

Output Range	
Air Velocity	Air Temp.
0 ~ 5 m/s	0 ~ 50 °C
0 ~ 25 m/s	0 ~ 100 °C
0 ~ 50 m/s	0 ~ 200 °C
	0 ~ 500 °C

Analog Output Terminal ⊖ ⊕ ⊕  
 V: Air Velocity  
 T: Air Temperature

### 5.1.1 How to Change Air Velocity Range

Display	Key	Procedure
↓ < MENU >	MENU	(1) Press MENU key.
1. MONITOR 2. MEASUREMENT 3. DATA OUTPUT 4. MEMORY CLEAR 5. UTILITY	▲, ▼ SET	(2) Select 5. UTILITY. Then press SET key.
↓ < UTILITY >		
1. CALENDAR 2. ANALOG OUTPUT 3. PROGRAM SET 4. RS-232C	▲, ▼ SET	(3) Select 2. ANALOG OUTPUT. Then press SET key.
↓ (a) < ANALOG OUTPUT >		
1. VELOCITY 2. TEMPERATURE	▲, ▼ SET	(4) Select 1. VELOCITY. Then press SET key.
↓		

<p style="text-align: center;">↓</p> <div style="border: 1px solid black; padding: 5px; margin-bottom: 5px;"> <p style="text-align: center;">&lt; RANGE &gt;</p> <p>1. 0 ~ 5 m/s</p> <p>2. 0 ~ 25 m/s</p> <p>3. 0 ~ 50 m/s</p> </div> <p style="text-align: center;">↓</p>			<p>(5)</p> <p>(a) The range highlighted is the current set range. If there is no change to be made, press <b>SET</b> key. The screen will go back to the ANALOG OUTPUT screen (a).</p>
<p style="text-align: center;">↓</p> <div style="border: 1px solid black; padding: 5px; margin-bottom: 5px;"> <p style="text-align: center;">&lt; RANGE &gt;</p> <p>1. 0 ~ 5 m/s</p> <p>2. 0 ~ 25 m/s</p> <p>3. 0 ~ 50 m/s</p> </div> <p style="text-align: center;">↓</p>	<p>△, ▽</p> <p>SET</p>		<p>(b) To change the range, select the range and press <b>SET</b> key.</p>
<p style="text-align: center;">↓</p> <div style="border: 1px solid black; padding: 5px; margin-bottom: 5px;"> <p style="text-align: center;">&lt; RANGE &gt;</p> <p>1. 0 ~ 5 m/s</p> <p>2. 0 ~ 25 m/s</p> <p>3. 0 ~ 50 m/s</p> </div> <p style="text-align: center;">↓</p>			<p>(6) The selected range will be highlighted, and the screen will automatically go back to the ANALOG OUTPUT screen (a).</p>
<p>(a) ↓</p> <div style="border: 1px solid black; padding: 5px; margin-bottom: 5px;"> <p style="text-align: center;">&lt; ANALOG OUTPUT &gt;</p> <p>1. VELOCITY</p> <p>2. TEMPERATURE</p> </div> <p style="text-align: center;">↓</p>	<p>MENU</p>		<p>(7) Press <b>MENU</b> key to go back to the menu screen.</p>
<p style="text-align: center;">↓</p> <div style="border: 1px solid black; padding: 5px;"> <p style="text-align: center;">&lt; MENU &gt;</p> <p>1. MONITOR</p> <p>2. MEASUREMENT</p> <p>3. DATA OUTPUT</p> <p>4. MEMORY CLEAR</p> <p>5. UTILITY</p> </div>			<div style="border: 1px solid black; padding: 5px; margin: 10px auto; width: fit-content;"> <p>To change the air temperature's output, perform the same procedure.</p> </div> <p>* Analog voltage is output only when the display screen indicates a measurement is being performed.</p>

**< Output Voltage Conversion >**

	Range	Conversion Equation
Air Velocity	0~ 5 m/s	$U = 0.005 \times V$
	0~25 m/s	$U = 0.025 \times V$
	0~50 m/s	$U = 0.05 \times V$
Air Temp.	0~50 °C	$T = 0.05 \times V$
	0~100 °C	$T = 0.1 \times V$
	0~200 °C	$T = 0.2 \times V$
	0~500 °C	$T = 0.05 \times V$

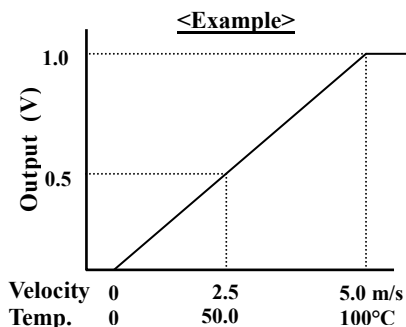

- [Symbols]
- U: Air Velocity (m/s)
  - T: Air Temp (°C)
  - V: Output Voltage (mV)

### 5.2 Digital Output (RS-232C)

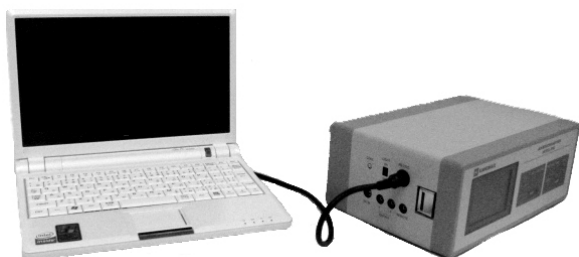

Output Format	
Baud Rate:	4800, 1200
Word Length:	8 bit
Parity Bit:	None
Stop Bit:	1 bit

#### 5.2.1 Connection Example

Signal Name	Wire Connection	Anemomaster (MODEL 6162)				
		Pin No.	Signal Name	Signal Meaning	Signal Direction	Signal Line Color
GND		1	GND	Signal Ground	- - -	Brown
TXD		2	RXD	Received Data	Input	Red
RXD		3	TXD	Transmit Data	Output	Orange
RTS		4	CTS	Clear To Send	Input	Yellow
CTS		5	RTS	Request To Send	Output	Blue
DSR						
DCD						
DTR						

#### 5.2.2 Baud Rate Setting

Display	Key	Procedure
	MENU	(1) Press <b>MENU</b> key.
	▲, ▼ SET	(2) Select <u>5. UTILITY</u> . Then press <b>SET</b> key.
	▲, ▼ SET	(3) Select <u>4. RS-232C</u> . Then press <b>SET</b> key.
	▲, ▼ SET	(4) Select baud rate. Then press <b>SET</b> key.
		(5) The selected baud rate will be highlighted, and the screen will automatically display menu screen.
		★ To transfer raw data: <u>1. MONITOR</u> To transfer memory data: <u>3. DATA OUTPUT</u>

**5.2.3 To Transfer Raw Data (measurement data per second)**

When transferring data, make sure to display the monitor screen.

While transferring data, do not use other functions.

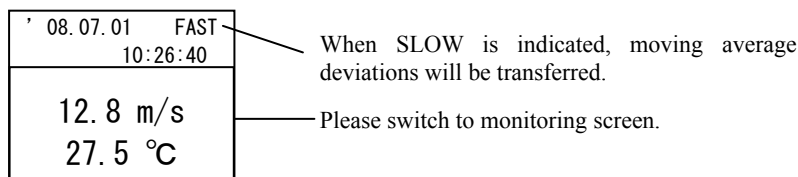

**Output Format**

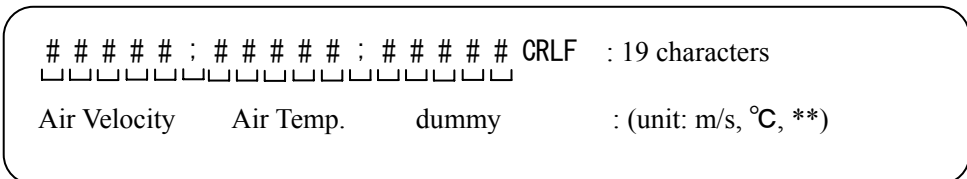

[Output Example]



**Command Explanation**

Command	Function	Explanation
D *	To set the number of data to be retrieved.	After command is received, AD will be returned. Then, the configured number of data (*) will be output every one second. <u>The maximum number of data to be output is 1,000 data.</u> To retrieve more than 1,000 data, send the command again.
C	To turn probe power OFF	After command is received, AC will be returned. At the same time, the air velocity sensor will be turned off.
S	To turn probe power ON	After command is received, the air velocity sensor will be turned on again. 30 seconds later AS will be returned and the instrument is ready to retrieve data. After <u>AS</u> command is received, transfer data by sending <u>D*</u> command.

\* Command C and S can be used when you want to collect data every one hour or so.  
By turning the probe off when it is not being used, unnecessary battery drain can be used.

\* When command or number of data is entered incorrectly, the error codes listed below will be returned.  
(Example: When the number of data exceeds the maximum, E2 will be returned in stead of AD.)

E1 ----- Command Error

B3 ----- Battery Error (battery drain)

E2 ----- Data Setting Error

**5.2.4 To Transfer Memory Data (Measurement Data Stored in Memory)**

DATA OUTPUT mode in menu screen

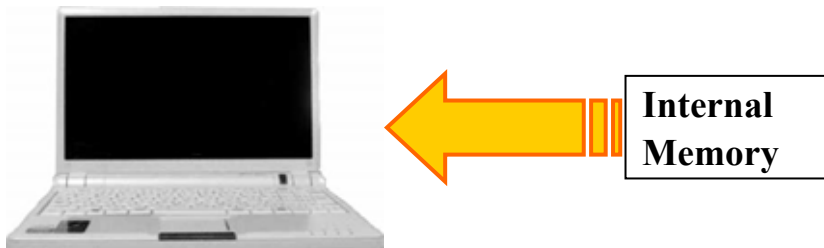

**Getting Ready for Transferring Memory Data**

Display	Key	Procedure
	<p>MENU</p>	(1) Press MENU key.
	<p>▲, ▼ SET</p>	(2) Select 3. DATA OUTPUT. Then press SET key.
	<p>▲, ▼ SET</p>	(3) Select 3. COMPUTER. Then press SET key.
	<p>Ready!</p> <p>Start Transferring</p>	(4) When the screen shown on the left is on the display, start (RUN) the program on your computer.  To Stop Transferring: MENU key

**An error message will be displayed when...**

1. RS-232C cable is not connected.
2. The wiring connection of the connector is not correct.  
Referring to the example of connecting to the host computer, check the wiring connection. (See 5.2.1 Connection Example (P.32))
3. Data cannot be retrieved.  
Baud rate may not be set correctly.  
Confirm the baud rate of the host computer and the instrument.

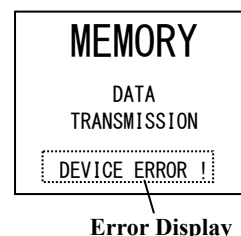



**Output Format of Measurement Condition ----- M Command**

```

(1)   (2)   (3)   (4)   (5)   (6)
## ; ## ; ## ; ## ; ### CRLF : 25 Characters
□□□□□□□□□□□□□□□□□□□□□□□□□□□□

```

(1) Measurement Mode (VI: Air Velocity & Air Temperature)

(2) Calculation Mode (AVE: Average Measurement INT: Interval Measurement FLW: Flow Measurement)

(3) S-TIME (S) (Sampling Time)

(4) DATA (N) (Number of Data to be collected)

(5) POINTS (No. of samplings (partitions))

(6) Interval Measurement: INT(measurement interval)  
Flow Measurement: AREA (m2) (Duct's cross section area)

\* AVG Mode:  
dummy output

[Output Example]     (1) (2) (3) (4) (5) (6)

```
VT ; FLW ; 60 ; 100 ; 10 ; 1. 456CRLF
```

**Output Format of Measurement Data ----- T Command**

```

##### ; ##### ; ##### CRLF : 19 Characters
□□□□□□□□□□□□□□□□□
air velocity air temp dummy : (Unit: m/s, °C, **)

```

[Output Example]     23.6;     126;     \*\*\* CRLF     : air velocity, air temp, dummy

<Command Explanation>

<b>Command</b>	<b>Function</b>	<b>Explanation</b>
P	To check the number of memory pages	After the command is received, AP will be returned. Then, the number of pages stored will be output.
N*	To check the number of memory data	After the command is received, AN will be returned. Then, the number of data in the specified page (*) will be output.
M*	To check measurement condition	After the command is received, AM will be returned. Then, the measurement condition in the specified page will be output.
T*	To output measurement data	After the command is received, AT will be returned. Then, the measurement data in the specified page will be output.

\* When page number is entered incorrectly, the error message E will be returned.  
As for E1 and E3, refer to **5.2.3 To Transfer Raw Data (measurement data per second)**.

## 6. Main Specification

	<b>Specification</b>																			
(1) Model Name	Main Unit: Model 6162 Probe: Model 0203 (for mid temperature) Model 0204 (for high temperature) Model 0205 (for high temperature)																			
(2) Measurement Feature	Air velocity and air temperature (simultaneous measurement)																			
(3) Measurement Object	Clean air under normal pressure and normal temperature																			
(4) Measurement Range	Air Velocity: $V_0 \sim 50.0\text{m/s}$ Air Temperature: $0 \sim 200\text{ }^\circ\text{C}$ (MODEL 0203) $0 \sim 500\text{ }^\circ\text{C}$ (MODEL 0204) $0 \sim 500\text{ }^\circ\text{C}$ (MODEL 0205) <table border="1" style="float: right; margin-left: 20px;"> <tr> <td><math>0 \sim 99\text{ }^\circ\text{C}</math></td> <td>: <math>V_0 = 0.2\text{ m/s}</math></td> </tr> <tr> <td><math>100 \sim 199\text{ }^\circ\text{C}</math></td> <td>: <math>V_0 = 0.4\text{ m/s}</math></td> </tr> <tr> <td><math>200 \sim 299\text{ }^\circ\text{C}</math></td> <td>: <math>V_0 = 0.7\text{ m/s}</math></td> </tr> <tr> <td><math>300 \sim 399\text{ }^\circ\text{C}</math></td> <td>: <math>V_0 = 1.0\text{ m/s}</math></td> </tr> </table>	$0 \sim 99\text{ }^\circ\text{C}$	: $V_0 = 0.2\text{ m/s}$	$100 \sim 199\text{ }^\circ\text{C}$	: $V_0 = 0.4\text{ m/s}$	$200 \sim 299\text{ }^\circ\text{C}$	: $V_0 = 0.7\text{ m/s}$	$300 \sim 399\text{ }^\circ\text{C}$	: $V_0 = 1.0\text{ m/s}$											
$0 \sim 99\text{ }^\circ\text{C}$	: $V_0 = 0.2\text{ m/s}$																			
$100 \sim 199\text{ }^\circ\text{C}$	: $V_0 = 0.4\text{ m/s}$																			
$200 \sim 299\text{ }^\circ\text{C}$	: $V_0 = 0.7\text{ m/s}$																			
$300 \sim 399\text{ }^\circ\text{C}$	: $V_0 = 1.0\text{ m/s}$																			
(5) Measurement Accuracy (Normal Temp. Accuracy: $18 \sim 28\text{ }^\circ\text{C}$ )	<table border="1" style="width: 100%; border-collapse: collapse;"> <thead> <tr> <th></th> <th>Measurement Range</th> <th>Specified Accuracy</th> <th>Display Resolution</th> </tr> </thead> <tbody> <tr> <td rowspan="4" style="text-align: center;">Air Velocity</td> <td><math>V_0 \sim 4.99\text{ m/s}</math></td> <td rowspan="4" style="text-align: center;"><math>\pm 3\%FS</math></td> <td style="text-align: center;">0.01 m/s</td> </tr> <tr> <td><math>5.00 \sim 9.99\text{ m/s}</math></td> <td rowspan="3" style="text-align: center;">0.1 m/s</td> </tr> <tr> <td><math>10.0 \sim 24.9\text{ m/s}</math></td> </tr> <tr> <td><math>25.0 \sim 50.0\text{ m/s}</math></td> </tr> <tr> <td rowspan="3" style="text-align: center;">Air Temp.</td> <td><math>0 \sim 99.9\text{ }^\circ\text{C}</math></td> <td rowspan="3" style="text-align: center;"><math>\pm 1\% \pm 1\text{ }^\circ\text{C}</math> of reading</td> <td style="text-align: center;">0.2 <math>^\circ\text{C}</math></td> </tr> <tr> <td><math>100 \sim 199\text{ }^\circ\text{C}</math></td> <td rowspan="2" style="text-align: center;">1 <math>^\circ\text{C}</math></td> </tr> <tr> <td><math>200 \sim 500\text{ }^\circ\text{C}</math> (0204/0205)</td> </tr> </tbody> </table>		Measurement Range	Specified Accuracy	Display Resolution	Air Velocity	$V_0 \sim 4.99\text{ m/s}$	$\pm 3\%FS$	0.01 m/s	$5.00 \sim 9.99\text{ m/s}$	0.1 m/s	$10.0 \sim 24.9\text{ m/s}$	$25.0 \sim 50.0\text{ m/s}$	Air Temp.	$0 \sim 99.9\text{ }^\circ\text{C}$	$\pm 1\% \pm 1\text{ }^\circ\text{C}$ of reading	0.2 $^\circ\text{C}$	$100 \sim 199\text{ }^\circ\text{C}$	1 $^\circ\text{C}$	$200 \sim 500\text{ }^\circ\text{C}$ (0204/0205)
	Measurement Range	Specified Accuracy	Display Resolution																	
Air Velocity	$V_0 \sim 4.99\text{ m/s}$	$\pm 3\%FS$	0.01 m/s																	
	$5.00 \sim 9.99\text{ m/s}$		0.1 m/s																	
	$10.0 \sim 24.9\text{ m/s}$																			
	$25.0 \sim 50.0\text{ m/s}$																			
Air Temp.	$0 \sim 99.9\text{ }^\circ\text{C}$	$\pm 1\% \pm 1\text{ }^\circ\text{C}$ of reading	0.2 $^\circ\text{C}$																	
	$100 \sim 199\text{ }^\circ\text{C}$		1 $^\circ\text{C}$																	
	$200 \sim 500\text{ }^\circ\text{C}$ (0204/0205)																			
(6) Temperature Compensation Accuracy (Air Velocity)	<table border="1" style="width: 100%; border-collapse: collapse;"> <thead> <tr> <th rowspan="2" style="text-align: center;">Temp. Velocity</th> <th>MODEL 0203</th> <th>MODEL 0204/0205</th> </tr> </thead> <tbody> <tr> <td><math>0 \sim 200\text{ }^\circ\text{C}</math></td> <td><math>0 \sim 400\text{ }^\circ\text{C}</math></td> </tr> <tr> <td><math>V_0 \sim 4.99\text{ m/s}</math></td> <td style="text-align: center;"><math>\pm 10\%FS</math></td> <td style="text-align: center;"><math>\pm 15\%FS</math></td> </tr> <tr> <td><math>5.00 \sim 9.99\text{ m/s}</math></td> <td rowspan="3" style="text-align: center;"><math>\pm 6\%FS</math></td> <td rowspan="3" style="text-align: center;"><math>\pm 10\%FS</math></td> </tr> <tr> <td><math>10.0 \sim 24.9\text{ m/s}</math></td> </tr> <tr> <td><math>25.0 \sim 50.0\text{ m/s}</math></td> </tr> </tbody> </table>	Temp. Velocity	MODEL 0203	MODEL 0204/0205	$0 \sim 200\text{ }^\circ\text{C}$	$0 \sim 400\text{ }^\circ\text{C}$	$V_0 \sim 4.99\text{ m/s}$	$\pm 10\%FS$	$\pm 15\%FS$	$5.00 \sim 9.99\text{ m/s}$	$\pm 6\%FS$	$\pm 10\%FS$	$10.0 \sim 24.9\text{ m/s}$	$25.0 \sim 50.0\text{ m/s}$						
Temp. Velocity	MODEL 0203		MODEL 0204/0205																	
	$0 \sim 200\text{ }^\circ\text{C}$	$0 \sim 400\text{ }^\circ\text{C}$																		
$V_0 \sim 4.99\text{ m/s}$	$\pm 10\%FS$	$\pm 15\%FS$																		
$5.00 \sim 9.99\text{ m/s}$	$\pm 6\%FS$	$\pm 10\%FS$																		
$10.0 \sim 24.9\text{ m/s}$																				
$25.0 \sim 50.0\text{ m/s}$																				
(7) Heat Resistance of Cable	Teflon Coated (probe side): $200\text{ }^\circ\text{C}$ Vinyl Code (connection cable): $80\text{ }^\circ\text{C}$																			
(8) Response	Air Velocity: 4 sec (90% response at air velocity of 5 m/s) Air Temperature: 5 sec (90% response at air velocity of 5 m/s)																			
(9) Display Screen	Graphic LCD (120×64dot): displaying velocity and temperature simultaneously w/t backlight and brightness adjustment functions																			
(10) Memory Capacity	Max 999 data (when measuring in one page)																			
(11) Input & Output Terminal	Remote Terminal: START/STOP function Analog output Terminal: simultaneous velocity & temp. output output voltage $0 \sim 1\text{V}$ (Output Impedance: $47\Omega$ ) (Output Accuracy: 0.5%FS) Digital Output Terminal: RS-232C (serial)																			

<b>General Specification</b>																																														
(12)Power Source Power Supply Voltage  Power Consumption	DC 9V (2A) Dry Cell: six (6) size C batteries (Alkaline Cell, Manganese Cell) AC Adapter: (100 ~ 240VAC 50 ~ 60Hz /0.2A) Max 5.6 VA																																													
(13)Battery Life	Approx. 8 hours (When the instrument is used consecutively with the backlight off with Alkaline cell at the velocity of 5m/s)																																													
(14)Backup Battery	Battery Life: Approx. 3 months ..... data and clock backup (This battery life is for the case where the instrument is not used at all for 3 months. As NiCd battery is used for a backup battery, it is charged every time it is used.)																																													
(15)Environment Condition (main unit) Performance Assurance Temp Range Storage Temperature Range	5 ~ 40 °C -10 ~ 50 °C																																													
(16)Dimension (main unit)	220 (W) × 85 (D) × 150 (H) mm																																													
(17)Dimension (probe)	<table border="1" style="width: 100%; border-collapse: collapse;"> <thead> <tr> <th style="width: 33%;">Model</th> <th style="width: 33%;">0203</th> <th style="width: 33%;">0204</th> <th style="width: 33%;">0205</th> </tr> </thead> <tbody> <tr> <td>Config</td> <td>φ11 × 208</td> <td>φ14 × 1000</td> <td>φ14 × 500</td> </tr> <tr> <td>ration</td> <td>Teflon coated cable</td> <td>Teflon coated cable</td> <td>Teflon coated cable</td> </tr> <tr> <td>Cable</td> <td>1.5m</td> <td>2.3m</td> <td>2.3m</td> </tr> </tbody> </table>	Model	0203	0204	0205	Config	φ11 × 208	φ14 × 1000	φ14 × 500	ration	Teflon coated cable	Teflon coated cable	Teflon coated cable	Cable	1.5m	2.3m	2.3m																													
Model	0203	0204	0205																																											
Config	φ11 × 208	φ14 × 1000	φ14 × 500																																											
ration	Teflon coated cable	Teflon coated cable	Teflon coated cable																																											
Cable	1.5m	2.3m	2.3m																																											
(18)Weight	Main unit: Approx. 1.8 Kg (inc. dry cell) Probe: MODEL 0203 Approx. 200 g MODEL 0204 Approx. 500 g MODEL 0205 Approx. 300 g																																													
(19)Accessories	<table border="1" style="width: 100%; border-collapse: collapse;"> <thead> <tr> <th colspan="2" style="text-align: center;">Main Unit (MODEL 6162)</th> <th style="text-align: center;">(Qty)</th> </tr> </thead> <tbody> <tr> <td>Shoulder Belt</td> <td></td> <td style="text-align: center;">1</td> </tr> <tr> <td>Dry Cell (sizes C Alkaline batteries)</td> <td></td> <td style="text-align: center;">6</td> </tr> <tr> <td>AC Adaptor (DC 9V, 660mA)</td> <td></td> <td style="text-align: center;">1</td> </tr> <tr> <td>Output Cable (alligator clip for analog output)</td> <td></td> <td style="text-align: center;">2</td> </tr> <tr> <td>Operation Manual</td> <td></td> <td style="text-align: center;">1</td> </tr> </tbody> </table> <table border="1" style="width: 100%; border-collapse: collapse;"> <thead> <tr> <th colspan="2" style="text-align: center;">Probe for Mid Temperature (MODEL 0203)</th> <th style="text-align: center;">(Qty)</th> </tr> </thead> <tbody> <tr> <td>Probe Board</td> <td></td> <td style="text-align: center;">1</td> </tr> <tr> <td>Storage Case for Probe</td> <td></td> <td style="text-align: center;">1</td> </tr> <tr> <td>Connection Cable (Vinyl: Approx. 5m)</td> <td></td> <td style="text-align: center;">1</td> </tr> </tbody> </table> <table border="1" style="width: 100%; border-collapse: collapse;"> <thead> <tr> <th colspan="2" style="text-align: center;">Probe for High Temperature (MODEL 0204/0205)</th> <th style="text-align: center;">(Qty)</th> </tr> </thead> <tbody> <tr> <td>Probe Board</td> <td></td> <td style="text-align: center;">1</td> </tr> <tr> <td>Storage Case for Probe</td> <td></td> <td style="text-align: center;">1</td> </tr> <tr> <td>Connection Cable (Vinyl: Approx. 10m)</td> <td></td> <td style="text-align: center;">1</td> </tr> <tr> <td>Reagent Bottle, Beaker, Bamboo Brush</td> <td></td> <td style="text-align: center;">1 each</td> </tr> </tbody> </table>	Main Unit (MODEL 6162)		(Qty)	Shoulder Belt		1	Dry Cell (sizes C Alkaline batteries)		6	AC Adaptor (DC 9V, 660mA)		1	Output Cable (alligator clip for analog output)		2	Operation Manual		1	Probe for Mid Temperature (MODEL 0203)		(Qty)	Probe Board		1	Storage Case for Probe		1	Connection Cable (Vinyl: Approx. 5m)		1	Probe for High Temperature (MODEL 0204/0205)		(Qty)	Probe Board		1	Storage Case for Probe		1	Connection Cable (Vinyl: Approx. 10m)		1	Reagent Bottle, Beaker, Bamboo Brush		1 each
Main Unit (MODEL 6162)		(Qty)																																												
Shoulder Belt		1																																												
Dry Cell (sizes C Alkaline batteries)		6																																												
AC Adaptor (DC 9V, 660mA)		1																																												
Output Cable (alligator clip for analog output)		2																																												
Operation Manual		1																																												
Probe for Mid Temperature (MODEL 0203)		(Qty)																																												
Probe Board		1																																												
Storage Case for Probe		1																																												
Connection Cable (Vinyl: Approx. 5m)		1																																												
Probe for High Temperature (MODEL 0204/0205)		(Qty)																																												
Probe Board		1																																												
Storage Case for Probe		1																																												
Connection Cable (Vinyl: Approx. 10m)		1																																												
Reagent Bottle, Beaker, Bamboo Brush		1 each																																												

# 7. Measurement Principle

## 7.1 Principle of Hot-Wire Anemometer

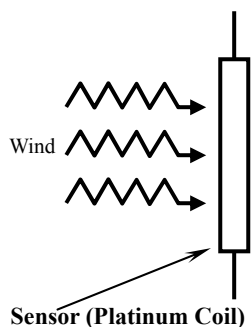

When the heated air velocity sensor is exposed to airflow, the sensor will be cooled. As the sensor temperature changes, the resistance value changes accordingly. The faster the velocity is, the greater the resistance value changes. Therefore, if how air velocity is proportional to the resistance value is understood, air velocity can be calculated using the measured resistance value (or electric current).

Our Anemomaster uses this principle. In general, a hot-wire anemometer employs a feedback circuit to keep constant temperature in the sensor area (Constant Temperature Anemometer).

The sensor temperature is kept at constant temperature, and this will not be affected by air velocity. However, the amount of heat drawn from the sensor changes depending on air velocity. In order to compensate the drawn heat, electrical current to be applied to the sensor. Based on the amount of the electrical current (i), the air velocity can be calculated.

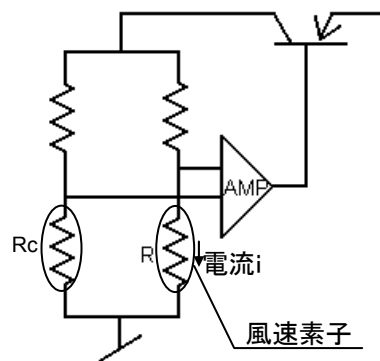

The amount of heat [H] that is drawn from the sensor is expressed by:

$$H = (a + b\sqrt{U})(T - Ta) \text{ ----- King's formula}$$

H: Heat Dissipation    T: Sensor Temperature  
 Ta: Air Temperature    U: Air Velocity    a, b: Constant

Also, the amount of heat diffusion can be expressed by the following formula;

$$H = RI^2$$

(R is kept constant regardless of air velocity as the temperature is constant.)

Therefore,  $RI^2 \propto a + b\sqrt{U}$

As you can see from this above formula, the change of air velocity [U] can be seen as the change of the current passed to the sensor [i].

### 7.2 Temperature Compensation

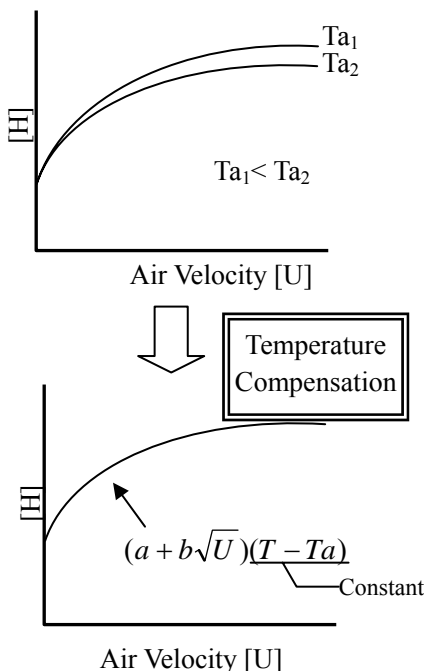

When the air temperature changes, the amount of heat dissipation changes accordingly even when the air velocity is constant. By providing a temperature measurement sensor  $R_c$  having the same temperature coefficient as the air velocity at the opposite side of the bridge, the constant difference between the air temperature and sensor temperature is kept. By fixing the bridge constant as described above, the amount of heat dissipation can bear a constant relation to the air velocity regardless of the air temperature.

When implementing the temperature compensation sensor, the sensor with significant resistance value shall be used in order to avoid self-heating due to the current flow. Consequently, the sensor tends to be big. The more the sensor is big, the worse the response against the air velocity sensor becomes. Then, when the air temperature changes rapidly, it becomes difficult to compensate the temperature. Given this factor, to improve the response of Model 6261 Anemomaster, sub-bridge is being used. If feedback is provided to amplifier in order to counterbalance this sub-bridge, the combined resistance will almost be  $R(1+r2/r1)$  when this bridge is viewed as one resistance. In other words, if  $r2 \ll r1$  is selected, the resistance for temperature detection ( $R$ ) can be relatively small. Therefore, we managed to keep the temperature detection sensor small, which enables us to achieve the compensation with good response.

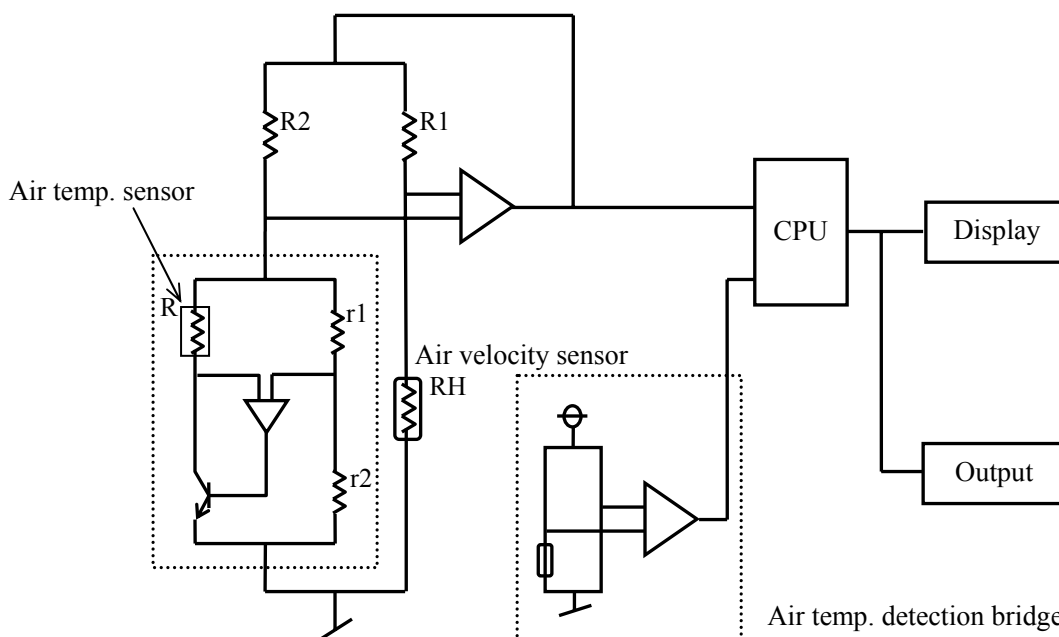

### 7.3 Influence by Gas Composition to be Measured

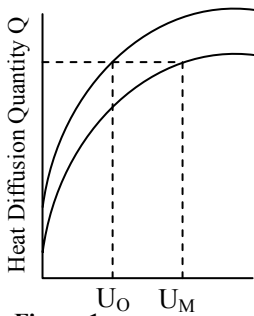

**Figure 1**  
Changes in air velocity values

Hot-wire Anemometers indicate air velocity based on the amount of radiation heat which is the heat quantity deprived from the sensor to fluid. Depending on the fluid to be measured, the amount of radiation heat varies, and the air velocity reading, too, will be affected. Since all of the Anemomaster are calibrated in air at the normal temperature and pressure, the indicated value requires to be compensated when you measure mixed gas. Therefore, you need to know the physical property value of the mixed gas beforehand in order to compensate the air velocity of mixed gas.

Below Figure 2 shows how to obtain the heat quantity diffused by the forced convection from a cylinder (sensor).

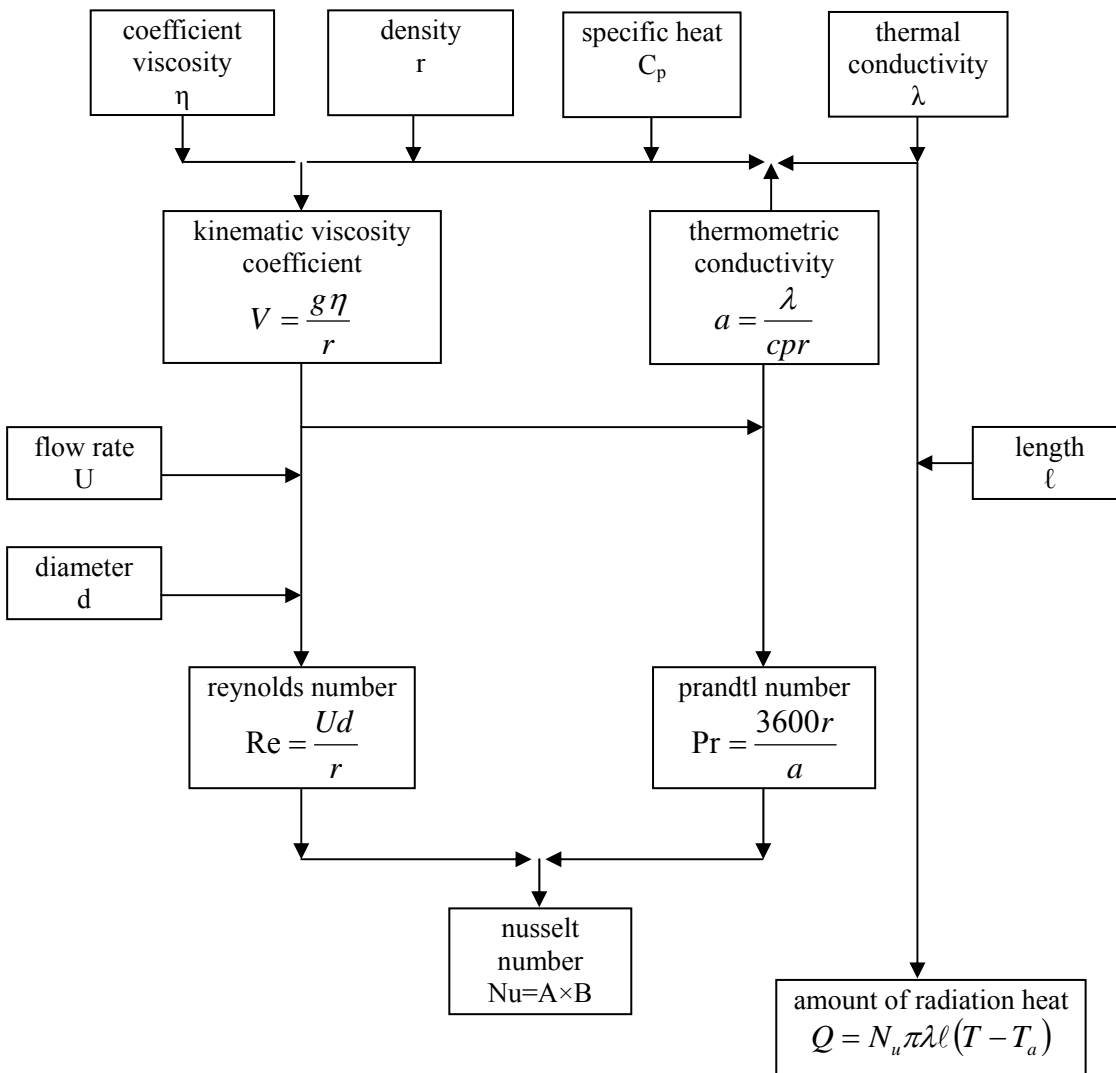

**Figure 2** Heat diffusion quantity due to forced convection from a cylinder

Heat diffusion quantity can be found by;

$$Q = N_u \pi \lambda \ell (T - T_a) \dots\dots (1)$$

Q: Heat diffusion quantity     $N_u$ : Nusselt number     $\pi$ : Circle ratio     $\lambda$ : Thermal conductivity  
 L: Length of cylinder    T: Heating body temp.     $T_a$ : Gaseous temperature

In order to obtain the property value of mixed gas, obtain the property value of each component. Based on the mixing ratio, the property value of the mixture can be found. For instance, the specific heat of mixture,  $C_p$ , can be found by;

$$C_p = \frac{\sum C_{p1} M_1 Y_1}{100M} \dots\dots (2)$$

$C_p$ : Specific heat of mixture     $C_{p1}$ : The specific heat of each component gas  
 M: Molecular quantity of mixture     $M_1$ : Molecular quantity of each component gas  
 $Y_1$ : Volume percentage of each component gas

As each property value is temperature function and Nusselt number,  $N_u$ , is function of flow velocity (U), heat diffusion quantity in the mixed gas ( $Q_a$ ) can be find by obtaining the air temperature,  $T_a$ , and the reference air velocity,  $U_0$  using the above equation (1). Given that the  $Q_a$  is equivalent to the diffusion quantity in the air, the air velocity value,  $U_M$ , can be obtained. With  $U_0$  and  $U_M$ , the air velocity compensation table for the mixed gas can be obtained.

Below is and example graph for air velocity compensation.

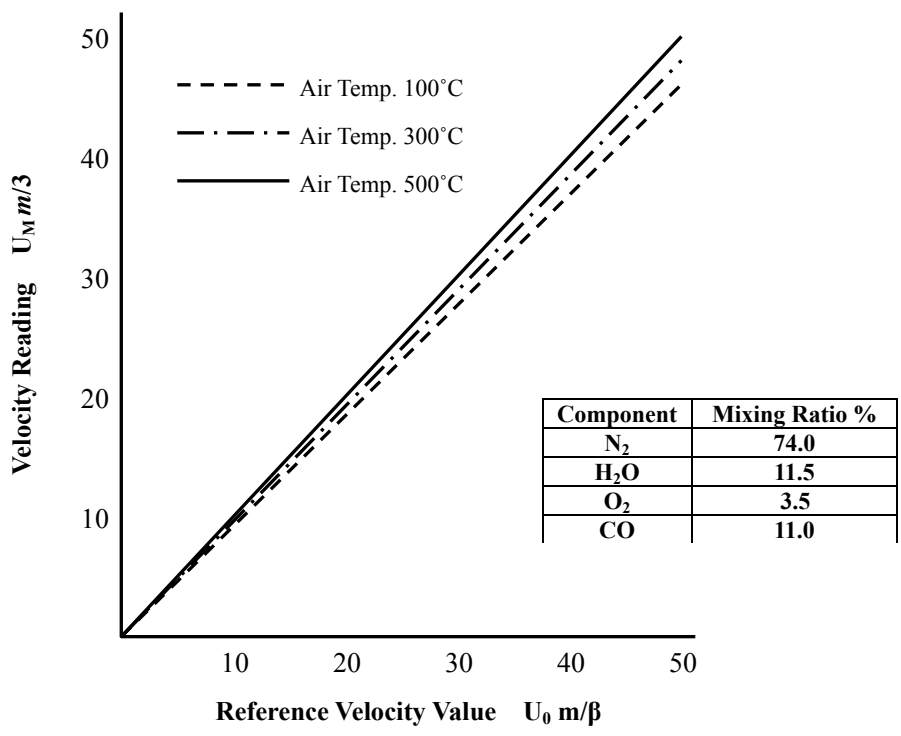

Figure 3 Example Graph for Air Velocity Compensation

## 8. Troubleshooting

\* Before you send the unit for repairs, please check the followings once again.

### 8.1 Checking Power Source

No.	Symptom	Possible Cause / Solution	Refer to
1.	Even when your turn the power switch ON, nothing is displayed.	- The batteries may be drained. ⇒ Need new batteries.	Page 5
2.	Although batteries are used, nothing is displayed on the screen.	- The brightness adjustment has not been done properly. ⇒ Adjust the brightness by the volume.	Page 2
3.	The dry cell dies faster than the specification.	- The polarity of the batteries are not correct. ⇒ Check the batteries.	Page 5
4.	The display screen blinks.	- It shows that the batteries are drained. ⇒ Need new batteries. Press BATT key and check the remaining level of the batteries.	Page 11

### 8.2 Checking the Initial Operation

No.	Symptom	Possible Cause / Solution	Refer to
1.	The display screen is dark or pale.	- The brightness adjustment has not been done properly. ⇒ Adjust the brightness by the volume. Ambient temperature affects the brightness.	Page 2
2.	The backlight is not ON.	- In a bright place it is sometimes difficult to check if the backlight is ON. ⇒ RIGHT Switch ON	Page 2
3.	When the instrument is turned ON, it goes to calculation mode automatically and “ready” is displayed.	- Calculation program is set. ⇒ <u>PROGRAM OFF</u>	Page 21
4.	Even if I select MEASUREMENT in the menu, the calculation mode selection screen does not display. In stead measurement condition setting screen displays.	- Calculation program is set. ⇒ <u>PROGRAM OFF</u>	Page 21
5.	“PROBE” keeps to be displayed on the screen.	- Probe is not connected. ⇒ Connect a probe.	Page 6



### 8.3 During a Measurement

No.	Symptom	Possible Cause / Solution	Refer to
1.	The displayed measurement value is abnormal. Ex) Air Velocity: **.* Air Temp: 0.0	- If a measurement is performed out of the spec range, "over" will be displayed on the screen. - Probe sensor may be damaged.	
2.	While measuring, the display screen starts blinking.	- The batteries are drained. ⇒ Need new batteries.	Page 11
3.	Data cannot be stored in the internal memory.	- Setting has not been configured properly. ⇒ <u>MEMORY YES</u>	Chapter 3
4.	The response of the reading is slow.	- Moving average deviations is selected. ⇒ <u>FAST/SLOW</u> key	Page 9

### 8.4 Analog Output

No.	Symptom	Possible Cause / Solution	Refer to
1.	No output.	- Output only on the initial screen or when measuring in the measurement mode? - The screen is on hold.	Page 30
2.	The output value is wrong.	- The output range is wrong.	

### 8.5 Digital Output

No.	Symptom	Possible Cause / Solution	Refer to
1.	DEVICE ERROR is displayed.	- The cable's wire connection is not correct.	Page 34
2.	Data cannot be collected.	- The host computer's setting is not properly configured. - Baud rate setting is not correct.	Page 32
3.	Data is wrong.	- Output format is not correct.	Page 33, 35

### 8.6 Printer

No.	Symptom	Possible Cause / Solution	Refer to
1.	The printer turns OFF while printing.	- The printer's NiCd battery is drained.	
2.	Cannot take a hardcopy of the screen.	- The screen may not be on hold. ⇒ Put the screen on hold. - You may be trying to take a hardcopy while measuring. ⇒ After the calculation, try again.	Page 13 Chapter 4
3.	There is not print output after calculation.	- Setting has not been configured properly. ⇒ <u>PRINT YES</u>	Chapter 4

## 9. Warranty and After-sales Service

### **KANOMAX Limited Warranty**

The limited warranty set below is given by KANOMAX with respect to the KANOMAX brand Anemomaster Model 6162, its attachment parts including Probe and other accessories (hereafter referred to as “PRODUCT”) that you have purchased. PRODUCT you have purchased shall be the only one that the limited warranty stated herein applies to.

Your PRODUCT, when delivered to you in new condition in its original container, is warranted against defects in materials or workmanship as follows: for a period of one (1) year from the date of original purchase, defective parts or a defective PRODUCT returned to your sales representative, as applicable, and proven to be defective upon inspection, will be exchanged for a new or comparable rebuilt parts, or a refurbished PRODUCT as determined by your sales representative. Warranty for such replacements shall not extend the original warranty period of the defective PRODUCT.

This limited warranty covers all defects encountered in normal use of the PRODUCT, and does not apply to the following cases:

- (1) Use of parts or supplies other than the PRODUCT sold by your sales representative, which cause damage to the PRODUCT or cause abnormally frequent service calls or service problems.
- (2) If any PRODUCT has its serial number or date altered or removed.
- (3) Loss of damage to the PRODUCT due to abuse, mishandling, improper packaging by the owner, alteration, accident, electrical current fluctuations, failure to follow operating, maintenance or environmental instructions prescribed in the PRODUCT's instruction manual provided by KANOMAX, or service performed by other than KANOMAX.

**NO IMPLIED WARRANTY, INCLUDING ANY IMPLIED WARRANTY OF MERCHANTABILITY OR FITNESS FOR A PARTICULAR PURPOSE, APPLIES TO THE PRODUCT AFTER THE APPLICABLE PERIOD OF THE EXPRESS LIMITED WARRANTY STATED ABOVE, AND NO OTHER EXPRESS WARRANTY OR GUARANTY, EXCEPT AS MENTIONED ABOVE, GIVEN BY ANY PERSON OR ENTITY WITH RESPECT TO THE PRODUCT SHALL BIND KANOMAX. KANOMAX SHALL NOT BE LIABLE FOR LOSS OF STORAGE CHARGES, LOSS OR CORRUPTION OF DATA, OR ANY OTHER SPECIAL, INCIDENTAL OR CONSEQUENTIAL DAMAGES CAUSED BY THE USE OR MISUSE OF, OR INABILITY TO USE, THE PRODUCT, REGARDLESS OF THE LEGAL THEORY ON WHICH THE CLAIM IS BASED, AND EVEN IF KANOMAX HAS BEEN ADVISED OF THE POSSIBILITY OF SUCH DAMAGES. IN NO EVENT SHALL RECOVERY OF ANY KIND AGAINST KANOMAX BE GREATER IN AMOUNT THAN THE PURCHASE PRICE OF THE PRODUCT SOLD BY KANOMAX AND CAUSING THE ALLEGED DAMAGE. WITHOUT LIMITING THE FOREGOING, THE OWNER ASSUMES ALL RISK AND LIABILITY FOR LOSS, DAMAGE OF, OR INJURY TO THE OWNER AND THE OWNER'S PROPERTY AND TO OTHERS AND THEIR PROPERTY ARISING OUT OF USE OR MISUSE OF, OR INABILITY TO USE, THE PRODUCT NOT CAUSED DIRECTLY BY THE NEGLIGENCE OF KANOMAX. THIS LIMITED WARRANTY SHALL NOT EXTEND TO ANYONE OTHER THAN THE ORIGINAL PURCHASER OF THE PRODUCT, OR THE PERSON FOR WHOM IT WAS PURCHASED AS A GIFT, AND STATES THE PURCHASER'S EXCLUSIVE REMEDY.**

## **After-sales Service**

---

If the PRODUCT is malfunctioning, please check with “Troubleshooting” to find possible cause first.

Repair parts are retained for a minimum period of five (5) years after production cessation of the PRODUCT. This storage period of repair parts is considered as the period during which KANOMAX can provide repair service.

For more information, please contact your sales representative. When you make a call, please have the following information of your PRODUCT at hand:

- (1) PRODUCT name;
- (2) Model number;
- (3) Serial number;
- (4) Probe number;
- (5) Description of Symptom, and;
- (6) Date of purchase

## 10. Contact Information



### JAPAN & ASIA

#### **KANOMAX JAPAN INC.**

2-1 Shimizu, Suita City, Osaka, 565-0805, Japan

**TEL:** 81-6-6877-0183 **FAX:** 81-6-6879-5570

**URL:** <http://www.kanomax.co.jp/>

**E-Mail:** [sales@kanomax.co.jp](mailto:sales@kanomax.co.jp)

### USA & EUROPE

#### **KANOMAX USA INC.**

PO Box 372, 219 Hwy. Route 206, Andover, NJ 07821, U.S.A.

**TEL:** (800)-247-8887 / (973)-786-6386 **FAX:** (973)-786-7586

**URL:** <http://www.kanomax-usa.com/>

**E-Mail:** [info@kanomax-usa.com](mailto:info@kanomax-usa.com)

### CHINA

#### **Shenyang Kano Scientific Instrument Co., Ltd**

No. 12, 4 Jia Wencui Road Heping District

Shenyang City, PRC

**TEL:** 86-24-23845309 **FAX:** 86-24-23898417

**URL:** <http://www.kanomax.com.cn/>

**E-mail:** [sales@kanomax.com.cn](mailto:sales@kanomax.com.cn)