

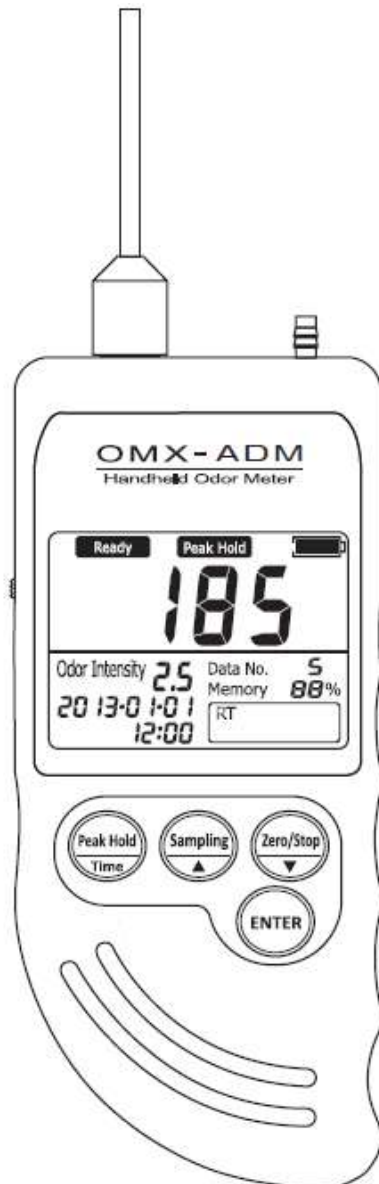

**KANOMAX**  
*The Ultimate Measurements*



# Handheld Odor Meter OMX-ADM

---

---

## Operation Manual

---

---

## Table of Contents

<b>1. Introduction.....</b>	<b>4</b>
1-1. Supplied Components List.....	4
1-2. Warning.....	5
1-3. Cautions .....	6
1-4. Unit Dimension .....	7
<b>2. General Description .....</b>	<b>8</b>
2-1. Features .....	9
2-1-1. LCD Display .....	9
2-1-2. Base Unit.....	10
2-2. Accessories .....	11
<b>3. Measurement .....</b>	<b>12</b>
3-1. Real-time Sampling Mode.....	12
3-1-1. Measurement Preparation .....	12
3-1-2. Measurement .....	13
3-2. Memory Sampling Mode .....	13
3-2-1. Measurement Preparation .....	13
3-2-2. Measurement .....	13
3-2-3. Memory Overflow.....	14
3-3. Peak-hold Function .....	15
3-4. Zero-point Function.....	15
<b>4. Data Filing Software.....</b>	<b>16</b>
4-1. How to Download Software.....	16
4-2. How to Install Software .....	16
How to Install USD Drivers Software .....	17
4-3. Preparation .....	18

4-4. Open Software .....	18
<b>5. Specification .....</b>	<b>19</b>
<b>6. Maintenance and Servicing .....</b>	<b>20</b>
6-1. Replacement of “AA” Alkaline Batteries .....	20
6-2. Replacement of Button Battery .....	20
6-3. Maintenance of Air Purifying Unit .....	21
6-4. Replacement of Filter for Suction Nozzle .....	21
6-5. Troubleshooting .....	22

## 1. Introduction

### 1-1. Supplied Components List

Thank you for purchasing of Shinyei Handheld Odor Meter.

Handheld Odor Meter is packaged carefully and includes all the components necessary for full operation.

Upon receipt, check the contents and find you received the items as below in good condition.

The instrument kit contains:

Name	Q'ty
OMX-ADM Base Unit	1
Suction Nozzle	1
AC Adaptor	1
'AA' Alkaline Battery	4
USB Connection Cable	1
Air Purifying Unit	1
Activated Carbon (50cc/bag)	1
Replacement Filter for Air Purifying Unit	4
Replacement Filter for Suction Nozzle	5
Operation Manual	1

## 1-2. Warning

Warning
<ul style="list-style-type: none"><li>● Do not use any adaptors except supplied original AC adaptor.</li><li>● Do not use in explosive atmosphere.</li><li>● Do not use the device where combustible and/or explosive gasses exist. The device is not designed for explosion proof.</li><li>● Do not dismantle the base unit.</li></ul>



### 1-3. Cautions

Cautions
<ul style="list-style-type: none"><li>● <b>Do not install, use, or store the unit at a place where:</b><ul style="list-style-type: none"><li>- Ambient temperature is not in the range of -10 to 40 degree in C. (14 to 104 degree in F)</li><li>- Ambient humidity exceeds 90%R.H.</li><li>- Condensation occurs due to rapid temperature change.</li><li>- Corrosive and/or explosive gases exist.</li><li>- Direct vibration and/or stream occur.</li><li>- Mush dust, salty materials, and/or iron powders exist.</li><li>- Static electrons, magnetic, and/or electronic noise occur.</li><li>- Cool or warm air from conditioners influences directly.</li><li>- The unit is exposed to direct sunlight.</li><li>- Heating occurs due to heat radiation.</li></ul></li><li>● <b>Do not use or store the unit at a place where the following gases exist:</b><ul style="list-style-type: none"><li>- Extremely concentrated odor.</li><li>- Cigarette smoke and/or oil mist.</li><li>- Silicon compound gas included in hair spray, adhesive, and silicon rubber etc.</li><li>- High concentrated chloride, acidic substances, corrosive gas, and chlorofluorocarbon etc.</li></ul></li><li>● <b>Exchange new batteries if battery status displays “Low.”</b></li><li>● <b>Do not use rechargeable batteries.</b></li><li>● <b>Do not use liquid such as benzene and/or thinner to clean the unit surface.</b></li><li>● <b>Do not block suction nozzle and/or exhaust nozzle.</b></li></ul>

**1-4. Unit Dimension**

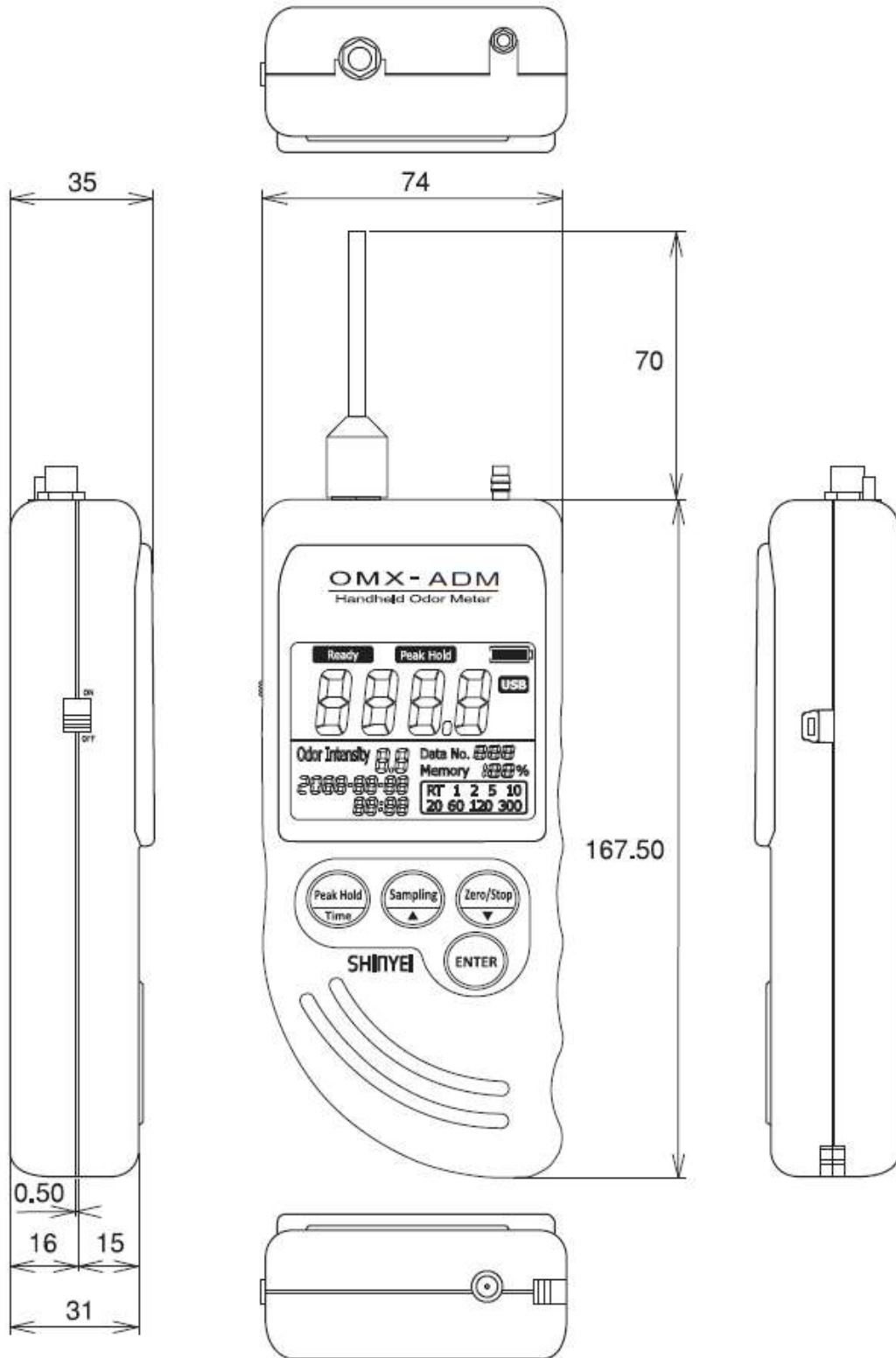

Unit: mm

## 2. General Description

Handheld Odor Meter is the most popular simplified tool for odor analysis which enables to show the relative odor strength numerically by comparing odor gases and purified air. The reading shown on the display is calculated based on our original principle.

With the installation of data filing software, measured data can be transferred to PC in easy steps.

### **Odor Strength**

Simply turn on the unit and start measurement.

Real-time relative odor strength can be measured continuously.

### **Odor Intensity**

Odor Strength is converted into ammonia odor intensity by the scale of 2.5 to 5.0 (in 0.1 unit) based on odor concentration of measurement environment.

**[NOTE]** Odor Intensity is determined based on Japanese Regulation that allows evaluating odor level by 6 scales.

### **Peak-hold**

Maximum odor strength level can be retained.

### **Memory Sampling Measurement Mode**

Up to 511 measuring data can be saved upon selecting sampling rate: 1, 2, 5, 10, 20, 60, 120 or 300 seconds.

### **Data Filing Software**

By using original data filing software, measuring data from the unit can be transferred to PC.

To download the latest data filing software, visit the link as below.

<http://www.kanomax-usa.com/product/handheld-odor-monitor-model-omx/#tab3>



## 2-1. Features



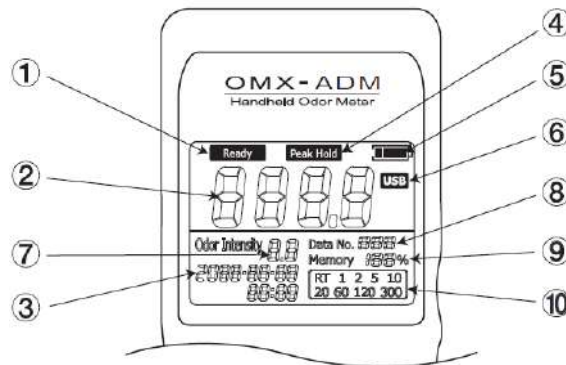

### 2-1-1. LCD Display



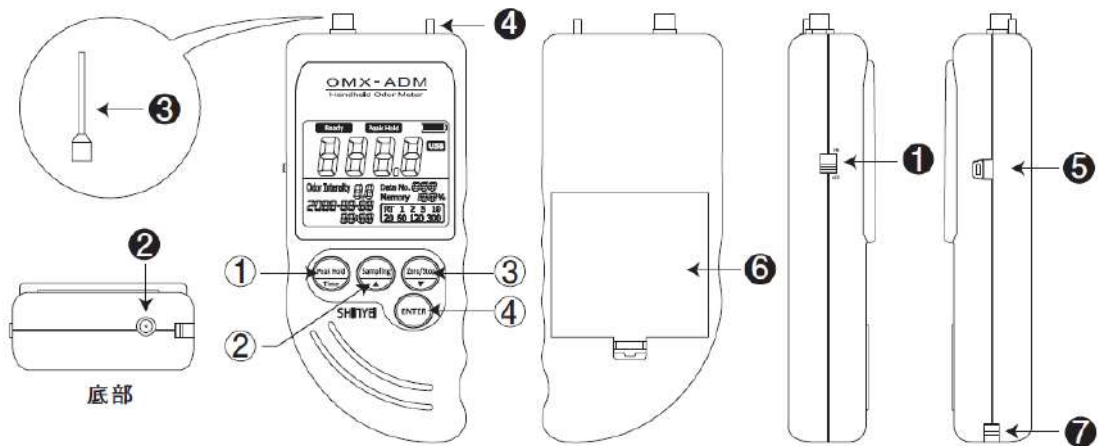

No.	Name	Function
①	Ready	Blinks for about 10min for initializing when the unit is turned on. Start measuring when it stops blinking.
②	Odor Strength	Displays odor strength in numeric value from 0 to 999. Start blinking when overflowed.
③	Calendar Function	Upper: Year-Month-Date Lower: Hour-Time
④	Peak Hold	Retains Maximum odor strength.
⑤	Battery Status	<ul style="list-style-type: none"> <li>■■■■ Full</li> <li>■■■□ Good – Measureable for 3 to 4 hours approx.</li> <li>■■□□ Moderate – Measureable for 1 to 2 hours approx.</li> <li>■□□□ Low – Change battery immediately.</li> <li>□□□□ No battery.</li> </ul>
⑥	USB	Shows USB Cable is connected.
⑦	Odor Intensity	Displays odor intensity of ammonia gas concentration based by the scale of 2.5 to 5.0 (in 0.1 unit). Hold ENTER for approx. 3 seconds to turn ON or OFF.
⑧	Data No.	Shows number of saved data.
⑨	Memory	Displays remaining memory capacity from 0 to 100%.
⑩	Sampling Rate	Select sampling rate. <b>NOTE</b> “RT” refers to Real-time Sampling that measures Odor Strength and Odor Intensity every 1 second continuously.

## 2-1-2. Base Unit



No.	Name	Function
①		<ul style="list-style-type: none"> <li>● Hold 3 seconds for “peak-hold function”. (See 3-3.)</li> <li>● Hold and turn on the device at the same time to set calendar.</li> </ul>
②		<ul style="list-style-type: none"> <li>● Select sampling rate. (See 3-2.)</li> <li>● Set calendar.</li> </ul>
③		<ul style="list-style-type: none"> <li>● Use for “zero-point function”. (See 3-4.)</li> <li>● Set calendar.</li> </ul>
④		Confirm sampling rate and/or “zero-point” function.
①	Power Switch	Turn on/off the unit.
②	AC Adaptor Port	Connect AC adaptor if necessary.
③	Suction Nozzle	Takes sampling air and/or object gases.
④	Exhaust Nozzle	Exhaust sampling air and/or object gases.
⑤	USB Port	Connect attached USB cable for PC connection.
⑥	Battery Box	Open/Close to replace batteries.
⑦	Hook Pin	Use for straps.

### Calendar Settings

1. Hold  and turn on the device at the same time to set calendar.
2. When “Year” is blinking, change to the arbitrary number.
3. Press  to confirm the settings.
4. Repeat 2. And 3. to set month, date, hour, and minute.

## 2-2. Accessories

Name	Function
AC Adaptor	Connect to the unit during the measurement if necessary.
Air Purifying Unit	Attach to the unit for “zero-point function”. (See 3-4.)
Activated Carbon	Exchange activated carbon when deodorization using air purifying unit is not effective.
Replacement Filter for Air Purifying Unit	Replace filter when deodorization using air purifying unit is not effective.
Replacement Filter for Suction Nozzle	Replace filter when gets dirt.
USB Connection Cable	Use to transfer measuring data from the unit to PC.

### 3. Measurement

#### 3-1. Real-time Sampling Mode

##### 3-1-1. Measurement Preparation

1. Place filter to suction nozzle.
2. Attach suction nozzle to the unit before measurement.

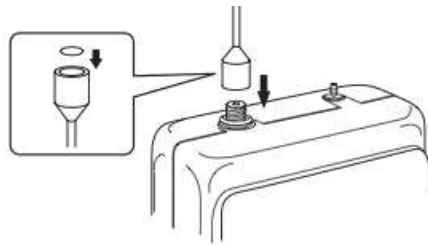

3. Use “AA” alkaline batteries or AC adaptor.

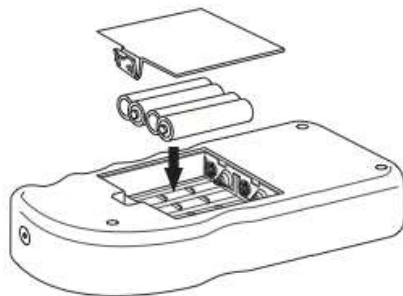

or



4. Turn on the unit at clean ambient.

It takes about 10 min for the unit initializing and start measuring.

**NOTE** The unit sets “zero” point when the initializing is done.

**NOTE** To get the zero point stable, initializing at clean environment is recommended.

**NOTE** To get “Zero” point forcibly, use air purifying unit. (See 3-4.)

### 3-1-2. Measurement

1. Turn on the unit and wait for about 10 minutes until “Ready” stop blinking and the initializing is done.
2. Start measuring.
3. Use data filing software if necessary.
4. Turn off the unit when odor strength shows close to “0”.

## 3-2. Memory Sampling Mode

### 3-2-1. Measurement Preparation

Refer to Page. 11.

### 3-2-2. Measurement



1. Turn on the unit and wait for about 10 minutes until “Ready” stop blinking and the initializing is done.

2. Press  until sampling rate on LCD display starts blinking.

3. Select sampling rate by pressing.

4. Press  to finish selecting sampling rate.



5. Press  (one time) and  (twice) to save data.

### 3-2-3. Memory Overflow

Memory overflow occurs when the internal memory is full.

If there is no space remained, calendar on LCD display starts blinking and data number becomes “0”.

To delete saved memory, press  and  at the same time while the unit is turned off.

Keep pressing  and  and turn on the device.



**NOTE** Saved memory in the unit will not be deleted automatically when it is transferred to PC.

### 3-3. Peak-hold Function

Press  for over 3 seconds during Real-time sampling.

By using this function, the highest value of odor strength keeps being displayed until the unit measures higher value.

**NOTE** Press  for over 3 seconds again to cancel the function.

**NOTE** The function is not displayed on the saved data.

### 3-4. Zero-point Function



By using this function, the unit sets the baseline accurately when it is turned on.

The unit sets the baseline at the place where the initialization is done.

After 10 minutes initializing, the unit will display Odor Strength “0” (baseline) automatically regardless of the measurement environment.

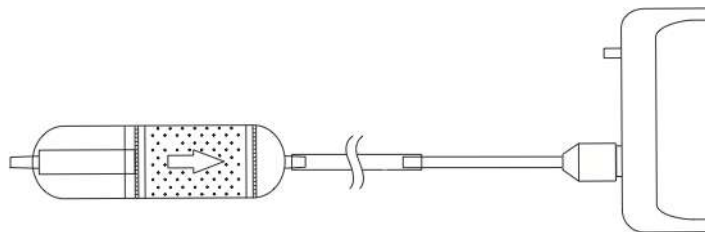
If you need to set the baseline accurately, connect Air Purifying Unit to purify the air forcibly.



1. Press  until calendar on LCD display “0” and starts blinking.
2. Press  to proceed, or press  to cancel.

**NOTE** If you set zero-point forcibly under dirty environment, odor strength may keep displaying “0”. In this case, please set zero-point again under clean environment.

**NOTE** Zero-point function cannot be performed in memory sampling mode.

## 4. Data Filing Software

Data filing software is used to transfer data from the unit to PC by using USB connection cable.

### 4-1. How to Download Software

Download the latest software from the link as below.

<http://www.kanomax-usa.com/product/handheld-odor-monitor-model-omx/#tab3>

**NOTE** Register personal information in order to download the file.

### 4-2. How to Install Software

Open “SetupADM\_en.msi” and follow the instruction on the window.

**NOTE** Install software under Windows administrative privileges.

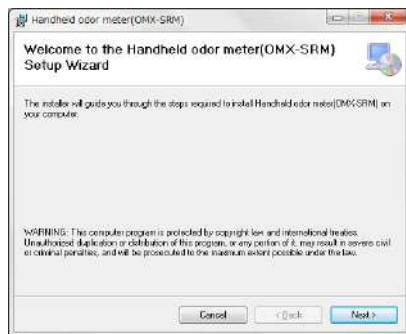



## How to Install USB Drivers Software

Install USB Drivers software before connecting USB cable to PC.

1. Download the latest software from the link as below.

<https://www.silabs.com/products/mcu/Pages/USBtoUARTBridgeVCPDrivers.aspx>

2. Install the software.

**NOTE** If PC CPU is 32bit, select  
“CP210xVCPInstaler\_x86.exe”.

If CPU is 64bit, select  
“CP210xVCPInstaler\_x64.exe”.

**NOTE** Warning message appears if  
incorrect file is selected.



3. Confirm Device Manager displays “Silicon Labs CP210x USB to UART Bridge (COM)” after the installation.
4. Confirm assigned COM number.

### 4-3. Preparation

Connect the unit to PC by USB connection cable.

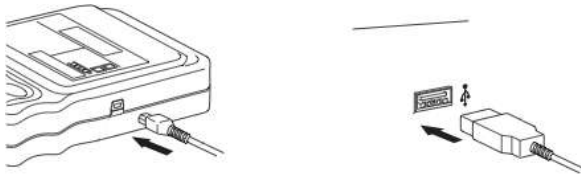

### 4-4. Open Software

1. Double-click shortcut icon on desktop, or open the file from program files.
2. Confirm main screen appears.



3. Read "Handheld Odor Meter Data Filing Software Manual" for details.

## 5. Specification

Detection Method	Semiconductor gas sensors
Object Gas	Hydrogen sulfide, methyl mercaptan, ammonia, etc.
Sampling Method	Continuous sampling by built-in pump
Detection Range	0 ppm to 25 ppm approx. (ammonia concentration)
Display	Digital LCD display
	Odor Strength (0 to 999)
	Odor Intensity (2.5 to 5.0)
Response Time	Ammonia (2ppm): Reaches 90% responsiveness within 20 seconds
	Ammonia (10ppm): Reaches 90% responsiveness within 20 seconds
Power Source	4 “AA” alkaline batteries or AC adaptor
Consumed Power	1,100mW approx. with “AA” alkaline batteries
Storage Temp. Range	0 to 40 degree in C (No dew condensation)
Dimensions	74(W) x 167.50(L) x 35(D)
Memory	32,732 data or 511 files

## 6. Maintenance and Servicing

### 6-1. Replacement of “AA” Alkaline Batteries

Replace “AA” alkaline batteries when battery status on LCD display becomes “Low”.

### 6-2. Replacement of Button Battery

The unit uses a button battery (model: CR2032) for memory back up.

When to replace:

- Past 5 years approx. after purchasing.
- Confirms when calendar or time on LCD display is incorrect.

1. Turn off the unit and remove “AA” alkaline batteries.

**NOTE** Do not connect AC adaptor.

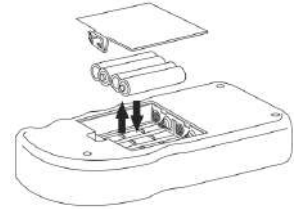

2. Push the round part of button battery firmly until the left part of button battery moves up.

3. Take out the battery.

**NOTE** Do not use metal tools or easily broken tools like screwdrivers or pencils.

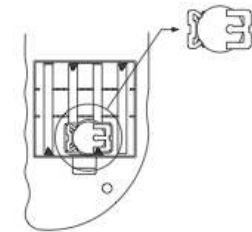

4. Insert the new battery.

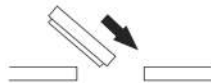

### 6-3. Maintenance of Air Purifying Unit

Replace activated carbon and filters in Air Purifying Unit to prevent gases absorbed in the unit.

1. Twist the Air Purifying Unit to open.

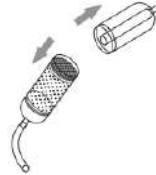

2. Take out top wire gauze, top filter, activated carbon, and bottom filter.

**NOTE** Do not take out bottom wire gauze.

3. Replace bottom filter and fill in activated carbon up to the line.

**NOTE** Do not exceed the line when replace activated carbon.

4. Replace top filter and top wire gauze.

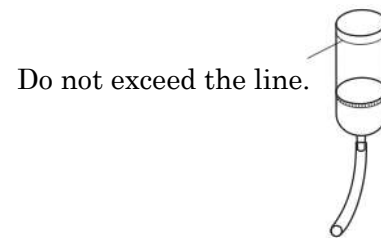
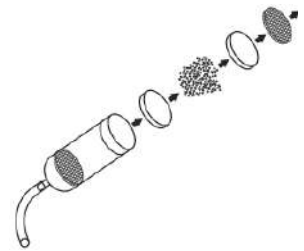
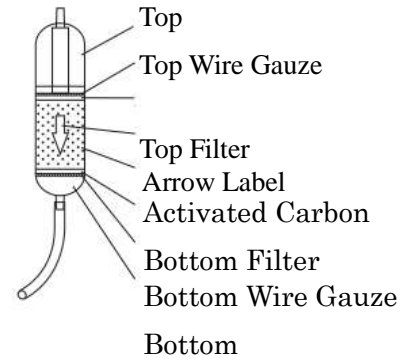

### 6-4. Replacement of Filter for Suction Nozzle

Twist Suction Nozzle and replace filter if necessary.

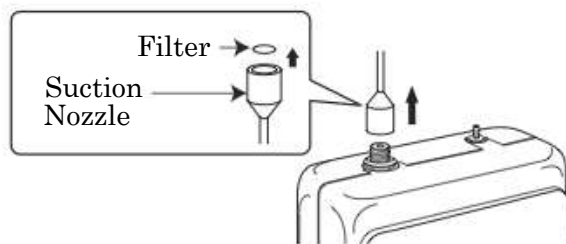



### 6-5. Troubleshooting

	<b>If you find:</b>	<b>Check:</b>
①	The unit does not operate.	Check battery status or connect AC adaptor.
		Check battery polarity.
②	Odor Strength does not change.	Get the unit closer to object.
		Connect Air Purifying Unit to clean the absorbed gas in the unit.
		Clean nozzle with alcohol and make sure to dry it up.
③	Odor Strength on LCD display keeps blinking.	Odor concentration is too high and overflowed. Try to lower the gas concentration.
④	Time on LCD display keeps blinking.	Memory is overflowed. Delete data.
⑤	Sampling rate cannot be selected.	Memory is overflowed. Delete data.
⑥	Data # becomes "0".	Memory is overflowed. Delete data.
⑦	"SErr" is shown on LCD display.	Sensor malfunction. Contact us if the message keeps being displayed.
⑧	"PErr" is shown on LCD display.	Built-in pump malfunction. Contact us if the message keeps being displayed.

KANOMAX USA Inc.

219 US HWY 206

ANDOVER, NJ 07821

[www.kanomax-usa.com](http://www.kanomax-usa.com)

973-786-6386