

Sound level meter  
MODEL 4431

Instruction manual

KANOMAX JAPAN INC.

## Components of this Instruction manual

This instruction manual refers to the functions of, and operating instructions for, Sound Level Meter MODEL 4431 (abbreviated to “this equipment” in what follows)

This instruction manual consists of following chapters.

### **Outline**

The components, characteristics, block diagram of this equipment are described

### **Locations and their functions**

The names and functions of keys and terminals are briefly described.

### **Liquid crystal screen**

The symbols displayed on the screen are described.

### **Preparation**

The power supply, check before use, installation of this equipment, connection of cables and various key setting are described.

### **Measurement**

Basic idea of measurement method is described.

### **Recording**

How to save or recall data is described.

### **Printing/Collecting**

How to print or collect the measurement data is described.

### **Output terminal**

Output terminal of this equipment is described.

### **Specification**

The specification of this equipment is described.

## Safety precautions

To prevent bodily injury or damage to property, the following safety precautions must be observed.

This manual contains important safety and operating instructions for this equipment.

Read all instructions, before using the instrument.

After reading all instructions, keep this manual for quick reference

### 1. Expressions of safety instructions

 <b>WARNING</b>
--

<i>Calls attention to a procedure, practice, or condition that could possibly cause death or bodily injury.</i>
---

 <b>CAUTION</b>
--

<i>Calls attention to a procedure, practice, or condition that could possibly cause bodily injury or damage to instrument.</i>
--

<b>NOTE</b>
-------------

<i>It is an advisory explanation to use this equipment correctly. (It is not a safety instruction )</i>
---

## 2. Important safety instructions

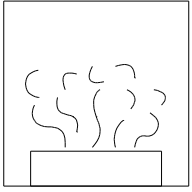
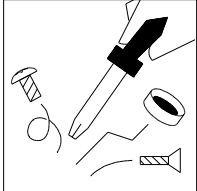
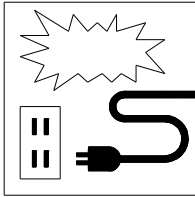
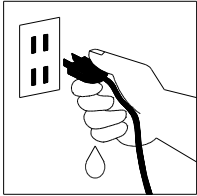
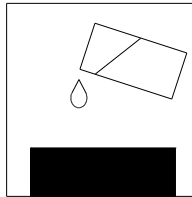
 <b>WARNING</b>	
<p>Stop using the instrument, when producing smoke, bad smell or noise. It causes fire or shock hazard. Turn off the POWER switch and unplug the AC adaptor (optional) from outlet as soon as possible. To reduce risk of injury, take it to a qualified serviceman when service or repair is required. Please contact us or the dealer when service or repair is required.</p>	
<p>Do not substitute parts or modify instrument. It causes bodily injury, fire or shock hazard.</p>	
<p>Do not use the AC power adaptor except the optional AC-1026. Other type of adaptor may cause damage to the instrument.</p>	
<p>Do not touch the plug of AC adaptor with wet hands. It causes shock hazard.</p>	
<p>Stop using the instrument, when an object or liquid falls/spills into the instrument. It causes fire or shock hazard. Turn off the POWER switch and unplug AC adaptor (optional) from outlet as soon as possible. To reduce risk of injury, take it to a qualified serviceman when service or repair is required. Please contact us or the dealer when service or repair is required.</p>	

### 3. Cautions for usage

This equipment is assembled with precision parts.

To prevent bodily injury or damage to the instrument, the following cautions must be observed.

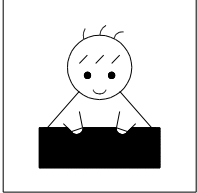
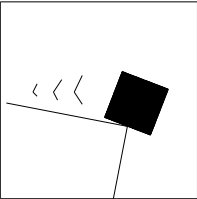
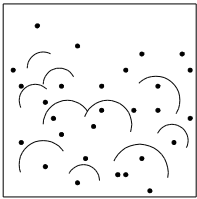
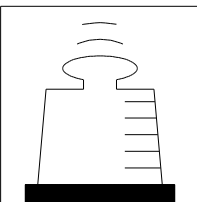
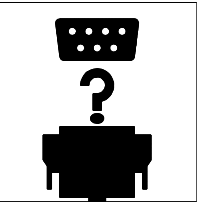
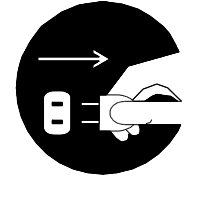
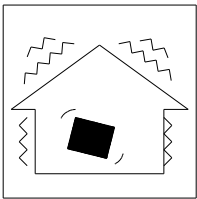
 <b>CAUTION</b>	
Keep the instrument away from the children. If the instrument falls down, it is very dangerous.	
Do not place it on an unstable place (shaky table or sloping place). If the instrument falls down, it is very dangerous.	
Do not expose the instrument to moisture or dust. It causes fire or shock hazard.	
Do not put heavy objects on the instrument. It causes damage to the instrument.	
Connect cable properly, it is instructed in this manual. Wrong connection causes fire hazard.	
Before you move the instrument to other place, turn off the POWER switch and remove all wiring.	
Do not put the instrument on the vibrating place. If the instrument falls down, it is very dangerous.	
For avoiding liquid spill, remove alkaline dry batteries when you don't use for long period of time. It is recommended to remove alkaline dry batteries after each use.	

## Disclaimer in usage of the software product

When this software is used, it is assumed that the customer has accepted all the following items.

- 1) The customer is permitted to use this software product based on the agreement of use conditions, not to transfer or sell to the third party.  
In case the customer cannot accept the following items, the product cannot be cleared to use, either.
- 2) The software product, together with attached documents such as instruction manuals, belongs to KANOMAX and is protected by the Copyright Law., etc.  
The customer is not permitted either to copy, modify, alter this software product, or remove the product label.  
The customer is not permitted to create any similar products, or have the third party do these actions.
- 3) Please do try hard to keep every user or users scheduled about the items above before the use of this product.  
As would be realized, the customer may be considered to have acted against the agreement when the user of this product acted against it.

## Disclaimer in usage of the SD card

- (1) The folder / file in the Memory card (SD card) please do not perform a change (addition and deletion) or a format from PC.  
When I changed it, normalcy does not work.
- (2) When I delete a data file in the memory card (SD card), please carry out deletion by using the main body of MODEL 4431.

<Contents of the Memory card (SD card)>

STD.....The folder of the data file of the normal measurement

001.csv	}	The data file (File name: 001.csv~999.csv)
.		
.		
nnn.csv		

TM5.....Power average value of the maximum sound pressure level in a given interval

001.csv	}	The data file (File name: 001.csv~999.csv)
.		
.		
nnn.csv		

## The Quantifier form of International standard and JIS (Japanese Industrial Standards).

The Quantifier is excerpted from ISO 1996, 3891, IEC 60804, JIS Z 8202, 8731.

Notation of MODEL4431		Name	Frequency weighting characteristics	ISO	IEC	JIS	
L <sub>A</sub>		A-weighted sound pressure level	A-weighted	L <sub>pA</sub>	—	L <sub>pA</sub>	
L <sub>C</sub>		C-weighted sound pressure level	C-weighted	—	—	—	
L <sub>P</sub>		Sound pressure level	Z-weighted	L <sub>P</sub>	—	L <sub>P</sub>	
L <sub>Aeq</sub>		Equivalent continuous A-weighted sound pressure level	A-weighted	L <sub>Aeq,T</sub>	L <sub>Aeq,T</sub>	L <sub>Aeq,T</sub>	
L <sub>Ceq</sub>		Equivalent continuous sound pressure level	C-weighted	—	L <sub>Ceq,T</sub>	—	
L <sub>eq</sub>		Equivalent continuous sound pressure level	Flat	—	—	—	
L <sub>AE</sub>		Sound exposure level	A-weighted	L <sub>AE</sub>	L <sub>AE</sub>	L <sub>AE</sub>	
L <sub>CE</sub>			C-weighted	—	—	—	
L <sub>E</sub>			Flat	—	—	—	
L <sub>AN</sub>	L <sub>A05</sub>	5% of the percentile sound pressure level	A-weighted	L <sub>AN,T</sub>	L <sub>A5,T</sub>	—	L <sub>A5,T</sub>
	L <sub>A10</sub>	10% of the percentile sound pressure level			L <sub>A10,T</sub>	—	L <sub>A10,T</sub>
	L <sub>A50</sub>	50% of the percentile sound pressure level			L <sub>A50,T</sub>	—	L <sub>A50,T</sub>
	L <sub>A90</sub>	90% of the percentile sound pressure level			L <sub>A90,T</sub>	—	L <sub>A90,T</sub>
	L <sub>A95</sub>	95% of the percentile sound pressure level			L <sub>A95,T</sub>	—	L <sub>A95,T</sub>
L <sub>Amax</sub>		Maximum sound pressure level	A-weighted	—	—	—	
L <sub>Amin</sub>		Minimum sound pressure level	A-weighted	—	—	—	
L <sub>Cpeak</sub>		Peak sound pressure level	C-weighted	—	L <sub>Cpeak</sub>	—	

# Contents

Overview .....	8
Locations and their functions .....	9
Front / Back / Side view of the main body.....	9
Operating Portion .....	10
Side view of the main body.....	11
System components.....	12
AC adaptor AC-1026.....	13
Mounting on the tripod.....	13
Memory Card(SD card)and program card(Option).....	13
Extension Cable(BC-0046).....	13
Connection with printer(BS2-80TS).....	13
Level recorder (TYPE 5008A).....	13
Connection with personal computer.....	14
Display (Explanation of measurement screen )	
Measurement screen.....	15~16
Preparation	
Battery installation.....	17
LCD back-light.....	18
LCD adjustment.....	19
Calendar adjustment.....	20
Calibration.....	21~22
Menu screen.....	23~27
Measuring Procedure	
Sound pressure level(Lp)measurement : Frequency weighting key Z.....	28
Temporal level display of Sound pressure level(Lp)measurement.....	29
A-weighted sound pressure level(L <sub>A</sub> /L <sub>C</sub> ):Frequency weighting key A,C.....	30
Time level display of A-weighted sound pressure level(L <sub>A</sub> /L <sub>C</sub> ).....	31
Equivalent continuous A-weighted sound pressure level(L <sub>Aeq</sub> )measurement.....	32
Single event sound exposure level(L <sub>AE</sub> )measurement.....	33
Maximum A-weighted sound pressure level(L <sub>Amax</sub> ), Minimum A-weighted sound pressure level(L <sub>Amin</sub> )measurement.....	34
Percentile level(L <sub>AN</sub> )measurement.....	35
Preak sound pressure level(L <sub>peak</sub> )measurement.....	36
C-weighted preak sound pressure level (L <sub>cpeak</sub> )measurement.....	37
C-weighted equivalent continuous sound pressure level (L <sub>Ceq</sub> )measurement.....	38
Power average value of the maximum sound pressure level in a given interval(L <sub>Atm5</sub> ) measurement.....	39
Impulse sound pressure level(L <sub>AI</sub> )measurement.....	40
Impulse equivalent continuous A-weighted sound pressure level (L <sub>AIeq</sub> ) measurement.....	41
Memory function	
Record of memory 【Nomal】mode, 【Auto】mode.....	42~45
Data recall from the memory .....	46
How to use the Memory card (SD Card ·Standard·).....	47~48
Example of file creation.....	49
Print/Data management	
Print .....	50
Saveing Data to PC.....	51
Out put terminal.....	52
Specifications .....	53~55
Pin Connections and How to Connect the Extension cable.....	57~58
Communication Command.....	59~64



## Overview

This specification refers to the Sound Level Meter MODEL4431. It covers most measurands corresponding to JIS and –ISO. The 4431, provided with many functions usually mounted in equivalent products, has been realized at an extremely low price.

Measurement of most measurands, such as Equivalent continuous A-weighted sound pressure level ( $L_{Aeq}$ ), Sound exposure level ( $L_{AE}$ ), A-weighted sound pressure level ( $L_A$ ), etc., is possible. The 4431 was developed to keep comfortable sound environment as well as safe and healthy life of people, both to be realized by the evaluation of environmental noise such as traffic noise or industrial equipment noise, or by better understanding of the labor health environment at offices, factories, etc.

The impressive design of 4431 symbolizes satisfactory operations and many performances related to JIS and/or IEC. It sure is a highly efficient and highly reliable precision sound level meter, to be supported by the next generation.

### Features

- Excellent cost/performance ; covers most measurands in current criteria
- The “0-dB” function 【 world first 】 (option) ; measurement of the noise of ultra-low sound pressure level is possible. The function displays the greatest force in the evaluation of “quietness” or sound quality of silent model of recent IT/OA equipments, as well as in those of air-conditioning noise level or sound isolation capability of newly built concert halls where the room ambient noise is below "NC-20 .
- Percentile sound pressure level ( $L_N$ ) ; any 5 selectable values is available
- Measurement of Equivalent continuous A-weighted sound pressure level ( $L_{Aeq}$ ) ; Measurement of environmental noise required to secure occupational heal
- Wide linearity range of 100dB ; Covers wide range of 20~130dB
- Equipped with an USB Ver1.1 function ; allows data processing for PC
- Equipped with a memory function ; realized by in built-in memory or memory card.
- Backlight LCD screen for high ; visibility and easy-on-the eye display
- Timer function ; measurement can be paused or restarted at any point of time by installing the function.
- Abundant program cards(Option) ; 1/1and 1/3-octave Real-time analysis card, FTT analysis Card, RSR card (Real sound recording Card), etc.

### Configuration

1) Sound Level Meter	MODEL4431	1
2) Memory Card ( SD Card )		1
3) Windscreen( $\phi$ 50)		1
4) Batteries	LR6	4
5) Screwdriver		1
6) Hand strap		1
7) Instruction manual		1
8) Carrying case		1
9) Option		
• 1/1 and 1/3-octave Real-time Analysis Card		NA-0038
• FFT Analysis Card		NA-0038F
• RSR Card ( Real Sound Recording Card )		NA-0038R
• Data management software		NA-0038M
• 0-dB function (0~80dB(A))		4431(0dB)
• AC adapter		AC-1026
• Output cable(BNC pin cord)		BC-0071
• USB interface cable		BC-0038PC
• Extension cable(2m~30m)		BC-0046-2~30
• Tripod exclusively for sound level meter		NA-0333
• Sound calibrator		TYPE2127

## Locations and their functions

### Front/Back/Side view of the main body:

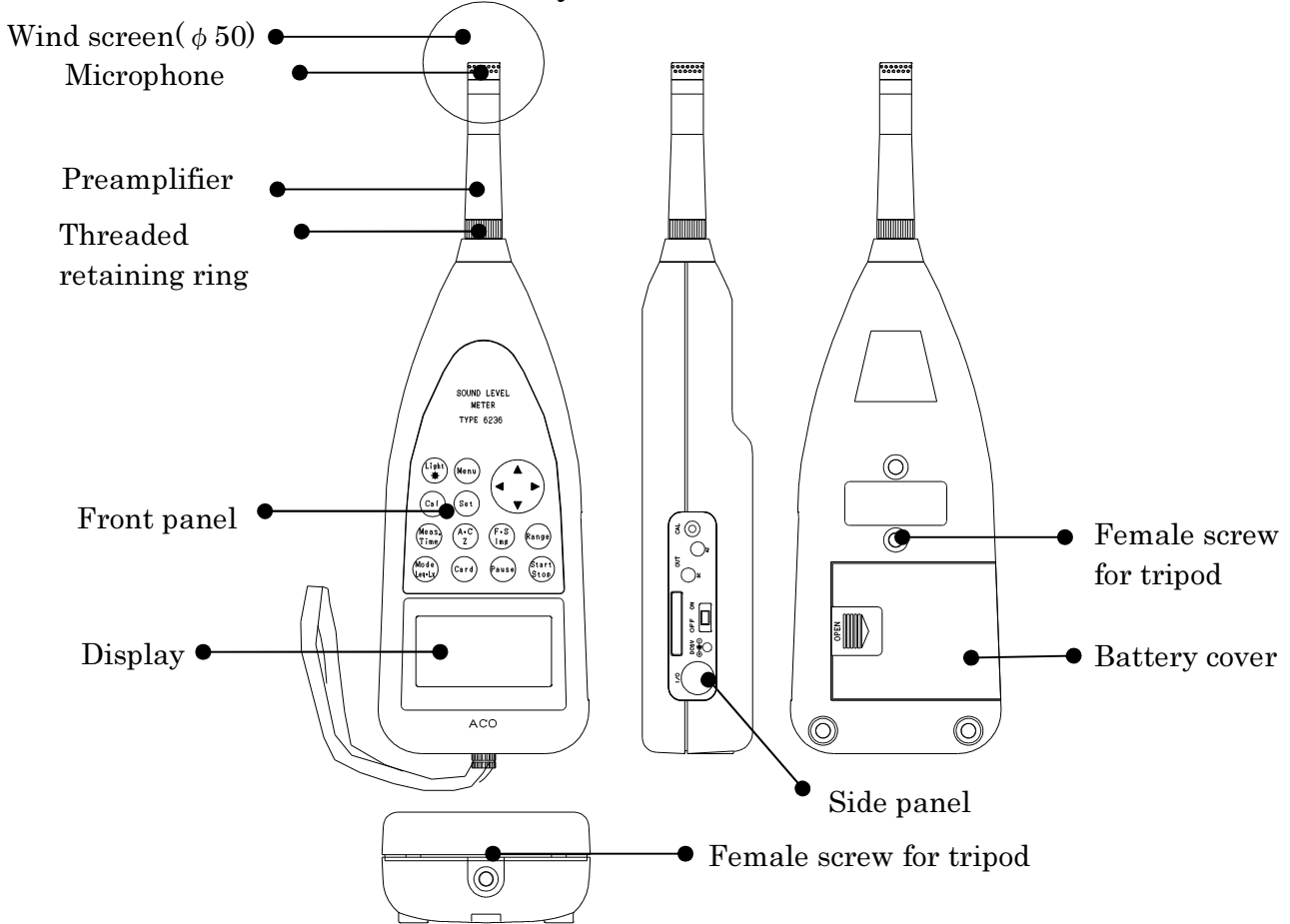

### Front

#### Microphone Preamplifier

The microphone and the preamplifier are comprised as one body.

They can be placed apart from the main body and connected to it with the optional extension cable

#### Display

It is a liquid crystal display with backlight. The sound level is displayed here with numerical value or bar graph. The operation condition of the sound level meter, setting condition of the measurement mode, various alerts, etc. are also displayed.

#### Windscreen(φ 50)

The measurement error may be caused in the windy outdoor site or noise measurement of ventilator, since the wind drives against the microphone generating the wind noise.

Under such conditions, it is possible to reduce the wind noise by attaching the φ 50 windscreen to the microphone

#### Strap

Used to prevent unexpected drop of the main body. Please put it through your wrist when you measure with the body in hand.

### Back

#### Female screw for tripod

It is possible to mount the main body to this tripod for the camera with screw.

#### Batteries case

Put four LR6 type Alkali dry batteries.

## Operating Portion

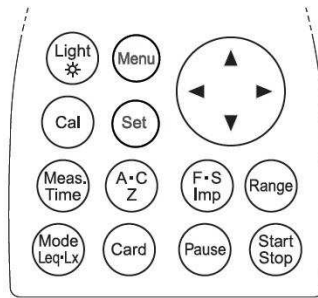

### Light key

The backlight illuminates the display in darkness, which goes out automatically 30 seconds later or by pushing the key again.

### Menu key

It is pushed to set up the measurement condition, when the display is adjusted to 1/3 page of the menu panel.

The item is selected with cursor key ▲▼, and input starts with ►, as well as the alteration with ▲▼. To go back to the measurement setting screen, push [SET] key again.

### Cal key

When the calibration or level setting with the equipment connected, this key is used.

### Set key

The key to be used to fix the input.

### Meas. Time key

The key to set the measurement period (interval time terminated with a pair of Star/Stop).

It changes on pushing the key as: key is pushed again.

1s, 3s, 5s, 10s, 1m, 5m, 10m, 15m, 30m, and 1h, 8h, 12h, 24h, and \*\*\* (Forever: Until Stop).

### A·C, Z key

The key to select frequency weighting A, C, and Z (FLAT)

### F·S, Imp key

The key to select time-weighting Fast, Slow, and Imp

### Range key

Range setting key which enables the following 6 ranges:

20~80, 20~90, 20~100, 20~110, 30~120, 40~130

### Mode Leq·Lx key

The key to display the calculation results. Each push gives various calculation results selected on the Menu screen.

### Card key

The key to use various option cards

### Pause key

By pushing the key, the measurement is paused to eliminate any unexpected noise or anomaly during the measurement. It is resumed by pushing the key again. By using the data elimination function, it is possible to exclude the data 3 or 5 seconds before the key is pushed.

### Start/Stop key

The key to start the measurement of various mode or to terminate it.

## Side view of the main body

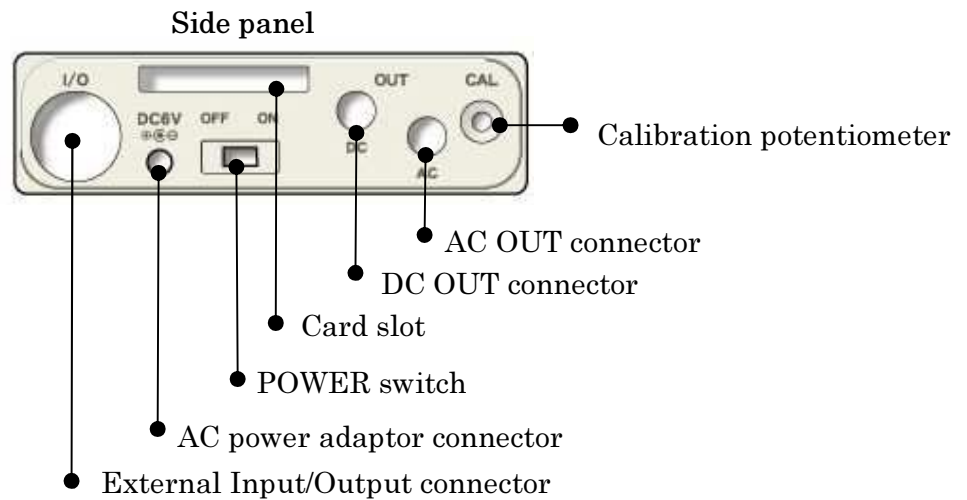

### AC power adaptor connector

By using the optional AC adaptor, AC100V is available for the measurement.

Please do not use any other power supplies than specified AC adaptor. It may cause breakdown or malfunction.

### AC/DC out connector

AC: outputs frequency-weighted AC signal.

DC: outputs DC level signal .

### External Input/Output connector

Input or output terminal for control signal or measurement data, which can be connected to a printer, level recorder, or personal computer.

### Card slot

The slot for memory card or optional program card.

NOTE
• Please watch out for the card slot portion when you have it in hand. The card may jump out.

### Inserting and detaching the card

1. Insert the card into the card slot on the side panel.  
Press softly the card into the slot until it comes to the end, watching for the direction of the card.



2. Press the card again for detaching it. The card comes off by itself.

## System configuration

### Example of system configuration

※The function can be extended by the connecting various option measuring instruments.

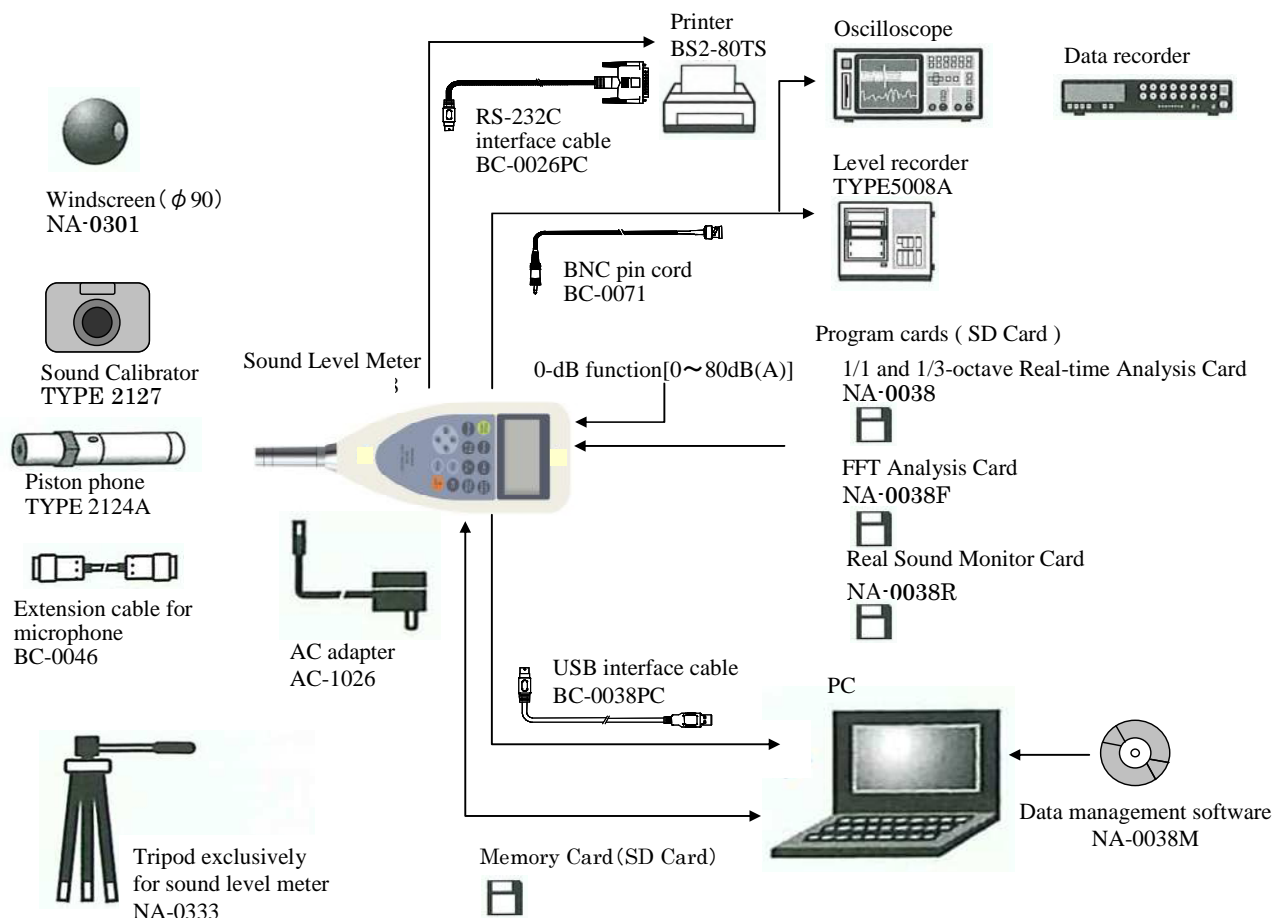

### AC adaptor (option)

- 1) Turn off the power switch.
- 2) Connect the option AC adaptor to the AC adaptor terminal.
- 3) Insert the AC plug of the AC adaptor to the AC100V outlet.

#### NOTE

Please do not use any other power supplies than specified AC adaptor. It may cause breakdown or malfunction.

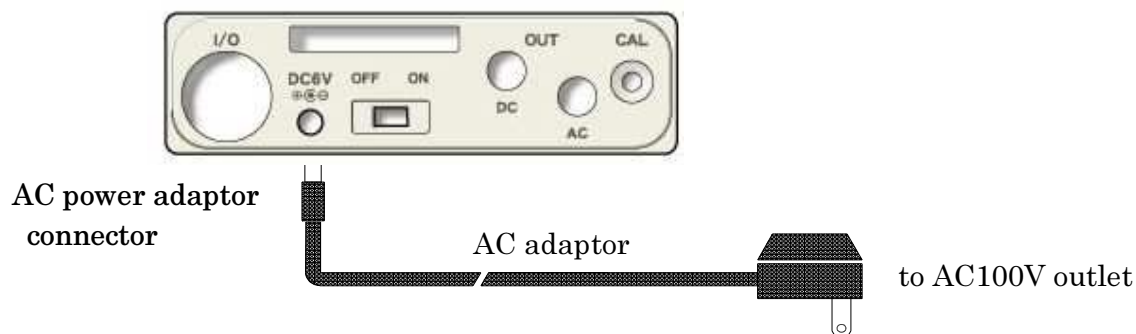

### Mounting on the tripod

It is possible to mount this equipment on the camera tripod in lengthy measurement.  
Please be careful enough not to drop the equipment or fell the tripod

### Memory card (SD card) and program card (Option)

The measurement results can be stored in Memory card (SD card) to reedit it on personal computer

Moreover, option program cards enable to set up the conditions of 1/1 or 1/3 octave filter card, FFT analysis card, and RSR card (Real sound recording card)

### Extension cable (BC-0046)

Please make sure to switch off the power when connecting or disconnecting the microphone extension cable.

To avoid the influence of diffraction effect of the sound level meter body, or of the existence of the measuring person, microphone can be placed away from the main body.

Please refer to “Pin Connections and How to Connect Extension cable” in P51 for further information.

NOTE
Never separate the microphone from the preamplifier, which may cause breakdown or malfunction

### Connection with printer (BS2-80TS)

Connect the serial input terminal of printer (BS2-80TS) to I/O terminal on the side panel with RS-232C interface cable (BC-0026PC). (both available as option).

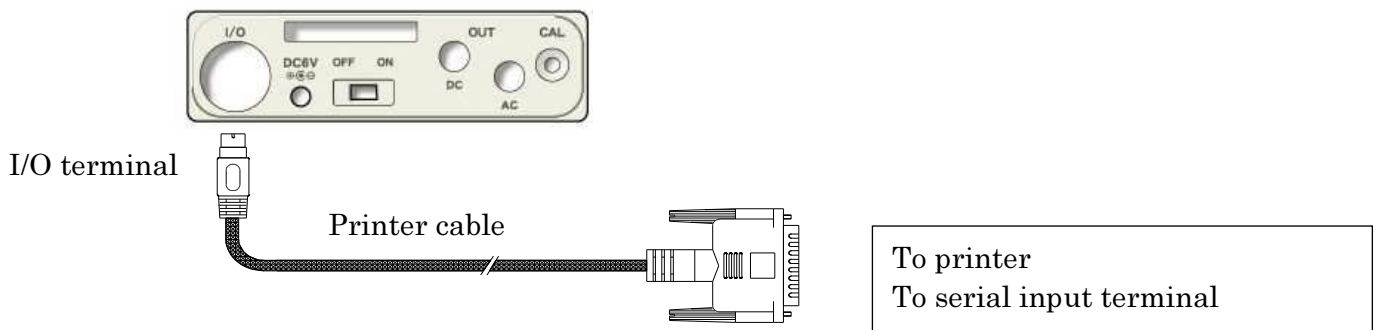

### Level recorder (TYPE 5008A)

How to record the sound pressure level

Connect AC output connector on the side panel to level recorder with output cable (BC-0071 : Option) as shown in the following figure.

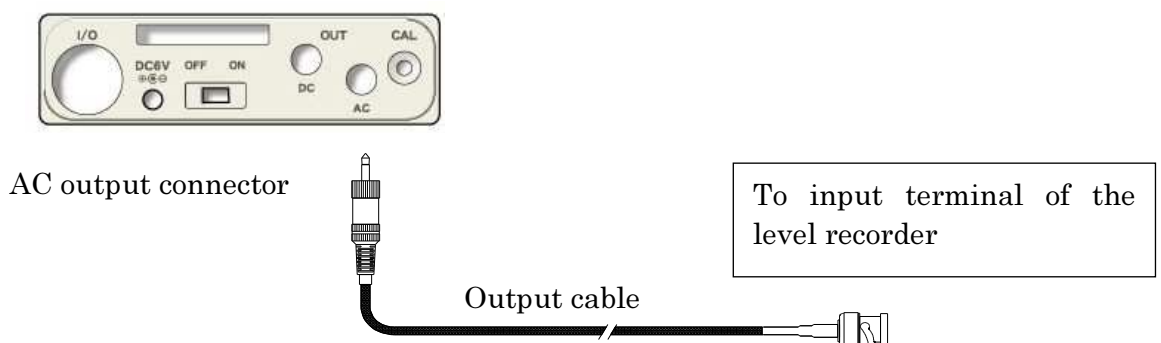

### Connection with personal computer

External connect I/O on the side panel to USB terminal of personal computer with the option interface cable.

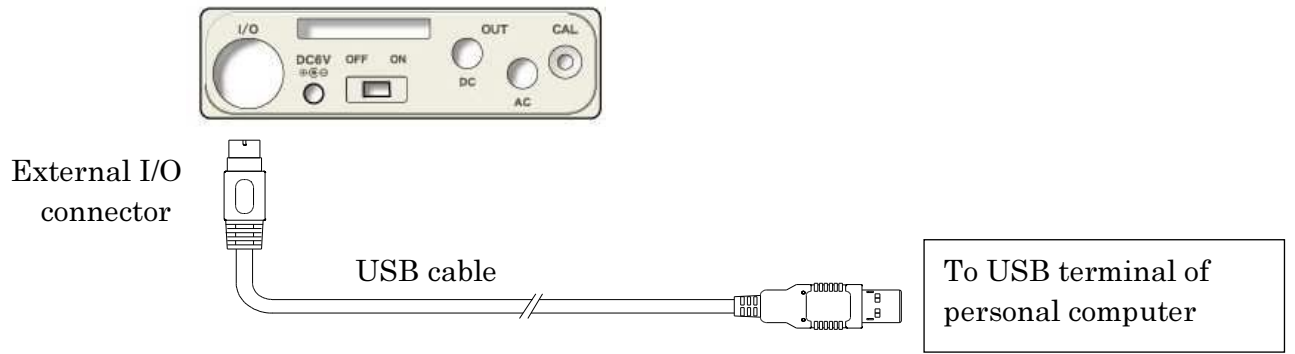

## Display (Explanation of measurement screen)

### Measurement screen

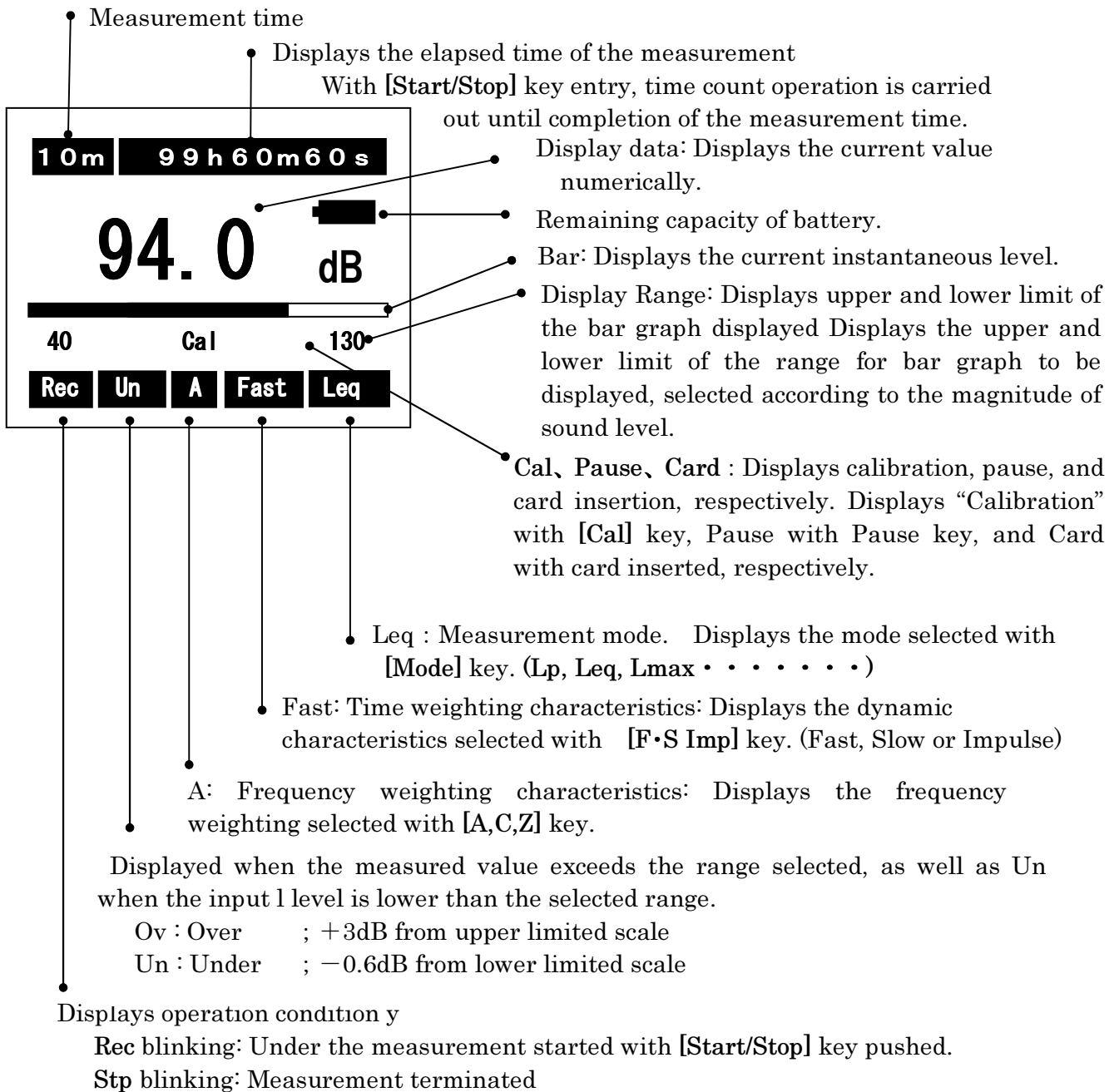

### Measurement time

The measurement time is displayed, which is one of the following :

1s, 3s, 5s, 10s, 1m, 5m, 10m, 15m, 30m, 1h, 8h, 12h, 24h, \* \* \* (Forever: Until [Start/Stop] key entry)

### Pause (Temporary interruption mark)

Blinks when the calculation or data saving to memory is canceled, where displayed level is not updated



## Frequency characteristic and Calculation function

Style		A	C	Z
Sound pressure level		$L_A$	$L_C$	$L_p$
Equivalent continuous sound pressure level		$L_{Aeq}$	$L_{Ceq}$	$L_{eq}$
Sound exposure level		$L_{AE}$	$L_{CE}$	$L_E$
Maximum sound pressure level		$L_{Amax}$	—	—
Minimum sound pressure level		$L_{Amin}$	—	—
Percentile sound pressure level ( $L_{AN}$ )	Percentile (5%) sound pressure level	$L_{A05}$	—	—
	Percentile (10%) sound pressure level	$L_{A10}$	—	—
	Percentile (50%) sound pressure level	$L_{A50}$	—	—
	Percentile (90%) sound pressure level	$L_{A90}$	—	—
	Percentile (95%) sound pressure level	$L_{A95}$	—	—
Peak sound pressure level		—	$L_{Cpeak}$	$L_{peak}$
Power average of maximum sound pressure level in a given interval		$L_{Atm5}$	—	—
Impulse sound pressure level		$L_{AI}$	—	—
Impulse equivalent continuous sound pressure level		$L_{Aeq}$	—	—

Display example

<Measurement screen>

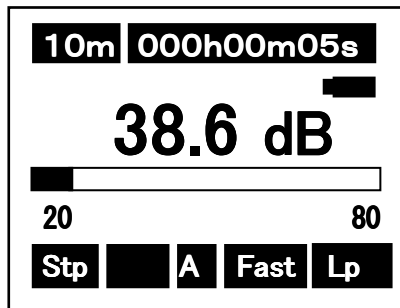

<Menu screen>

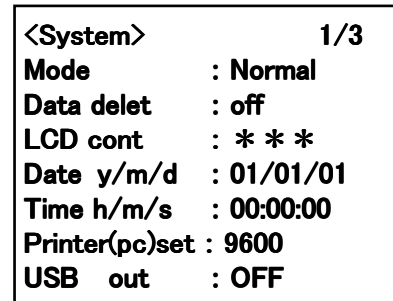

<Example of T·L (time level) display>

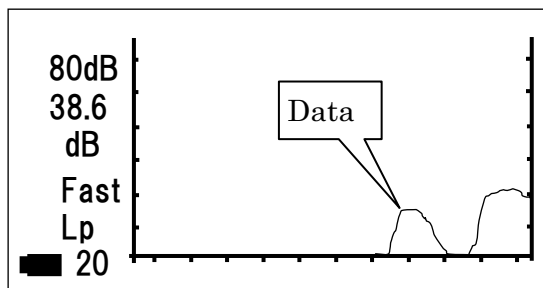

## Preparation

### Battery installation

When LCD display tells low battery, install new batteries.

For long-term measurement, install new batteries in advance.

The following displays tell you the condition of the batteries.

The battery residual quantity display are the 5 stages like the following.



It will blink,  
if "EMPTY" is displayed,  
and a power supply is  
shut off.

### To install new batteries:

- 1) Turn off the POWER switch.
- 2) The slide is done while pushing the battery lid by the thumb. (Refer to the figure below).
- 3) Put the new batteries in the case, then shut the cover. The inside of the case shows you the direction of the batteries.

#### NOTE

Do not put the batteries in the wrong direction. These four batteries should be replaced at the same time.

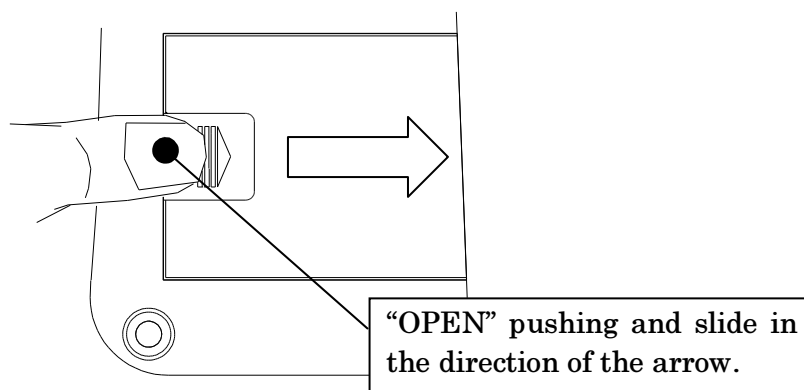

- Battery life is approximately:
  - 9 hours (Alkaline batteries, continuous operation)
- Use of LCD back-light shortens the life of the batteries (approximately 1/3).
- Please prepare the AC adaptor AC-1026(option) in advance when it is used for a long period of time.

## LCD back-light

You can use LCD back-light, when your measurement is carried out in the dark situations.

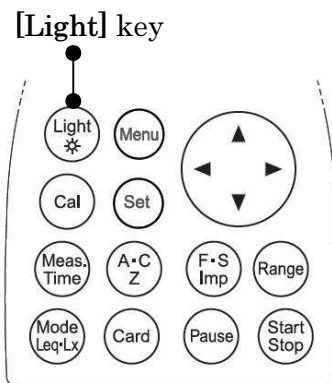

- 1) Press **[Light]** key, LCD back-light goes on.
- 2) If you press **[Light]** key again, LCD back-light goes out.  
The light automatically goes out in about 30 seconds after the light goes on.
- 3) When the batteries is low, LCD back-light dims.

NOTE
Use of LCD back-light shortens the life of the batteries.

## LCD adjustment

You can adjust LCD contrast, when the batteries were low, or when the new batteries were installed.

The procedure is as follows.

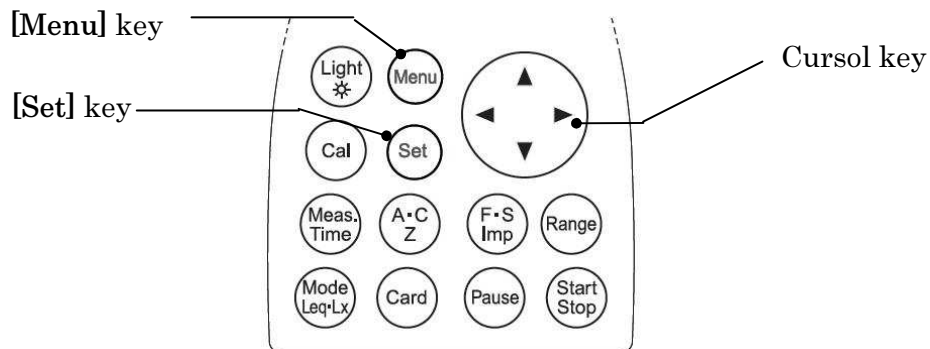

- 1) When you press the [Menu] key, the following screen appears.

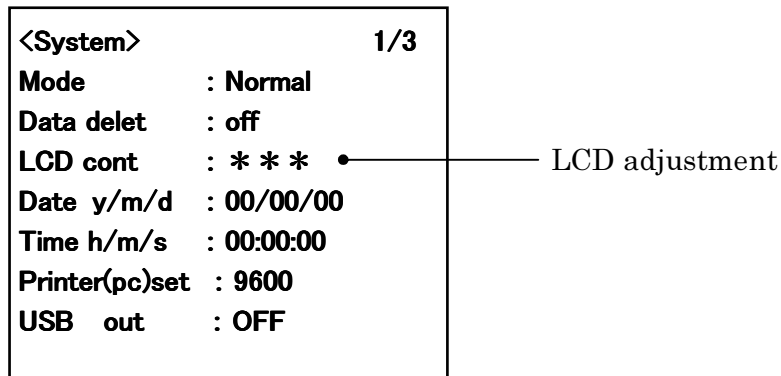

- 2) Select LCD cont with Cursor key ▼, then move the cursor rightward with ► key.
- 3) Adjust the LCD contrast with ▲▼ key, then press [Set] key to save the setting. After pressing [Set] key, the cursor moves to leftward.
- 4) If you want to go back to measurement mode, press [Set] key.

## Calendar adjustment

To adjust the calendar (time), operate as follows.

You can adjust calendar in the Menu mode in the same way as LCD adjustment.

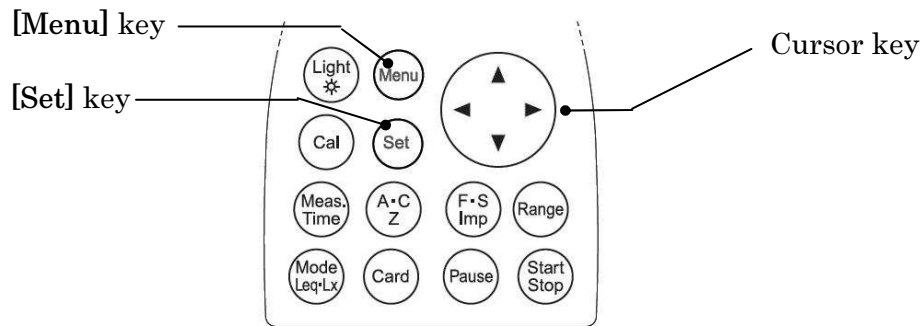

When you press the [Menu] key, the following screen appears

<b>&lt;System&gt;</b>	<b>1/3</b>		
<b>Mode</b>	<b>: Normal</b>		
<b>Data delet</b>	<b>: off</b>		
<b>LCD cont</b>	<b>: * * *</b>		
<b>Date y/m/d</b>	<b>: 00/00/00</b>	●	● Date adjustment
<b>Time h/m/s</b>	<b>: 00:00:00</b>	●	● Time adjustment
<b>Printer(pc)set</b>	<b>: 9600</b>		
<b>USB out</b>	<b>: OFF</b>		

### 【Calendar adjustment】

- 1) Select date y/m/d with Cursor key ▼, then move the cursor rightward with ► key.
- 2) Set the year/month/day with ▲▼ key, then press [Set] key to save the setting.  
After pressing [Set] key, the cursor moves to leftward.
  1. If you want to go back to the measurement mode, press [Set]key.

### 【Time adjustment】

- 1) Select time with Cursor key ▼, then move the cursor rightward with ►key.
- 2) Set the hour:minute:second with ▲▼ key, then press [Set] key to save the setting.  
After pressing [Set] key, the cursor moves leftward.
- 3) If you want to go back to the measurement mode, press [Set] key.

NOTE	
Be sure to enter the date (date y/m/d) in the order of “year → month → day.”	
Input any figure of: y(year): 00 – 99, m(month):01 – 12, and d(day): 01 – 31.	
Ex.) For November 30, 2003	
Correct)	03/11/30
Incorrect)	11/30/03 30 has been entered for m(month). Input any figure of 01 through 12.
Be sure to enter the time in the order of “hour → minute → second.”	
Input any figure of: h(hour): 00 – 24, m(minute): 00 – 59, s (second) 00 – 59.	
Ex.) For 23:58:32	
Correct)	23/58/32
Incorrect)	32/58/23 32 has been entered for h(hour). Input any figure of 00 through 24.

NOTE	
You are recommended to set the built-in IC timer right before measurement, since it could show the wrong time.	

## Calibration

You need to calibrate the instrument regularly before you start taking measurements. There are two types of calibration. One is the way using the internal generator, the other is the way using the pistonphone. Note that calibration is disabled when “Peak measurement” is selected

### Calibration using internal generator

You can calibrate the instrument using the internal generator (1kHz, sine wave)

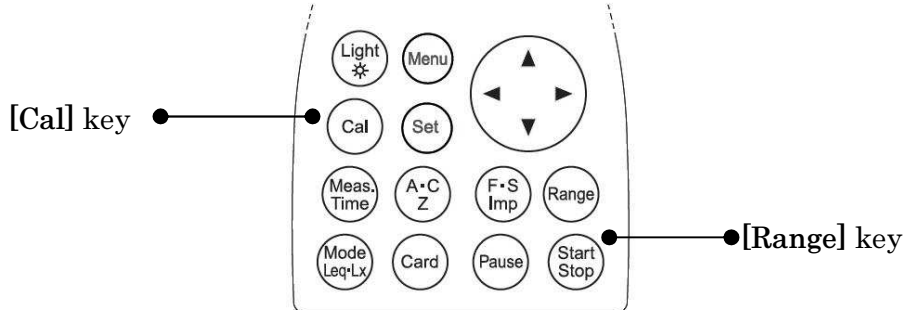

- 1) Turn on the POWER.
- 2) Press [Cal] key.
- 3) Press [Range] key, and choose '100dB' by cursor keys ▲▼, and press [Range] key again to register.
- 4) Adjust the calibration potentiometer on the side panel until the display shows 94dB.
- 5) If [Cal] key is pressed once again, the calibration is completed.

### < Calibration display >

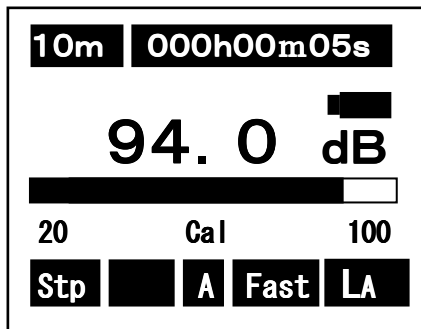

← Cal flashes on and off

### < Side panel >



• Calibration potentiometer

### < Reference > Full scale range and Cal(the display shows)

Full scale range (dB)	CAL (dB)	OUTPUT(V)	
		AC OUT	DC OUT
80	74.0	0.500	2,350
90	84.0	0.500	2,350
100	94.0	0.500	2,350
110	104.0	0.500	2,350
120	114.0	0.500	2,350
130	124.0	0.500	2,350

Pistonphone ( MODEL 2124 A) or Calibration using Sound Calibrator ( MODEL 2127 )

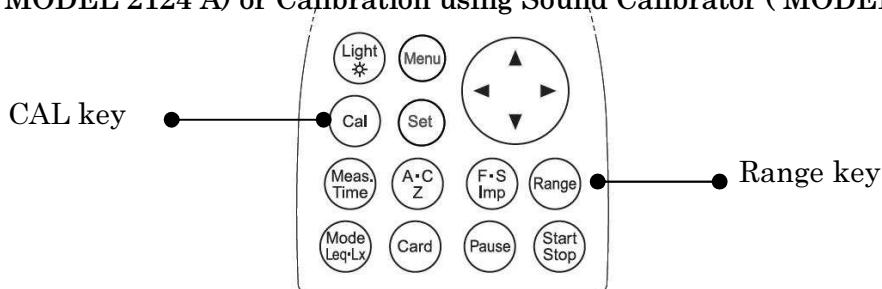

- 1) Turn off the POWER of Pistonphone (MODEL 2124A) or Sound Calibrator (MODEL 2127).
- 2) Turn on the POWER of this equipment
- 3) For the Pistonphone, Set the frequency weighting to Z with Frequency weighting key, set the time weighting to Fast with Time weighting key and set the range to 40~130dB with [Range] key.  
For the Sound Calibrator, Set the frequency weighting to Z with Frequency weighting key, set the time weighting to Fast with Time weighting key and set the range to 20~100dB with [Range] key.
- 4) Insert microphone of this equipment to Pistonphone ( MODEL 2124A ) or Sound Calibrator ( MODEL 2127 ).
- 5) Switch on the Pistonphone ( MODEL 2124A ) or Sound Calibrator ( MODEL 2127 ).
- 6) Adjust the calibration potentiometer on the side panel until the display shows a output level of the pistonphone (standard value is 124dB) and a output level of the sound Calibration (standard value is 94dB).

<Pistonphone in use>

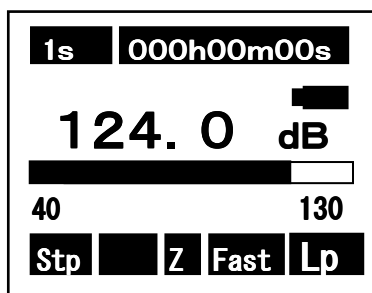

< Sound Calibrator in use >

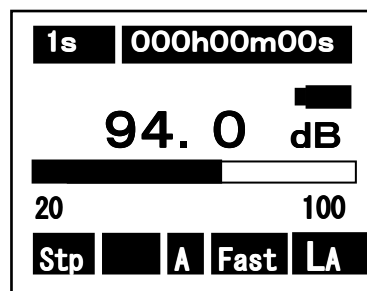

NOTE

Insertion and extraction of the microphone to/from the sound calibrator should be made slowly and softly. Rapid insertion and extraction may cause strong force to the diaphragm of the microphone due the air pressure change, which may then give a severe damage to the microphone.

## Menu screen

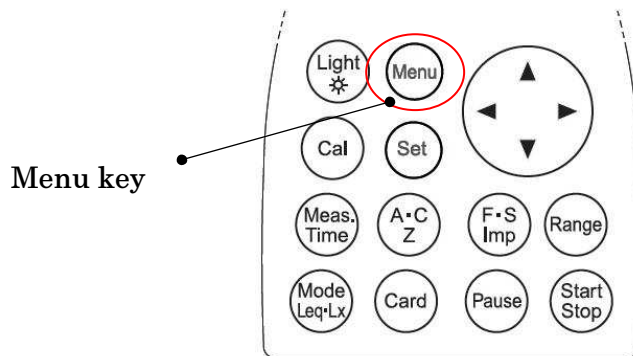

With [Menu] key pressed, the following Menu screen appears. (Under the situation with [Start/Stop] key not pressed).

<System> 1/3 → <Memory> 2/3 → <View Mode> 3/3 → <System> 1/3 → <Memory> 2/3 . . .

Each [Menu] key pressed, you can select one of three screens as above, and return to the measurement setting screen. .

Select an item with cursor keys ▲ ▼, start the input with ►, and fix the change with [Set] key. Move to the item to change and return to the measurement setting screen with [Set] key again.

In the use of option card (filter card), additional setting screen appears.

Please refer to the manual of each option card for the details .

<b>&lt;System&gt;</b>		<b>1/3</b>
<b>Mode</b>	:	Normal
<b>Data delet</b>	:	off
<b>LCD cont</b>	:	* * *
<b>Date y/m/d</b>	:	01/01/01
<b>Time h/m/s</b>	:	00:00:00
<b>Printer(pc)set</b>	:	9600
<b>USB out</b>	:	OFF

<b>&lt;Memory&gt;</b>		<b>2/3</b>
<b>Mode</b>	:	Normal
<b>Interval</b>	:	Single

<b>&lt;View Mode&gt;</b>		<b>3/3</b>
<b>Lp</b>	:	INST
<b>(A)View</b>	LA05	: OFF
<b>LAeq</b>	: ON	LA10 : OFF
<b>LAE</b>	: OFF	LA50 : OFF
<b>L Amin</b>	: ON	LA90 : OFF
<b>L Amax</b>	: ON	LA95 : OFF

Each change made with various key operations are registered and reproduced on next Power ON operation.



<System> (1/3)

<System>	1/3
Mode	: Normal
Data delet	: off
LCD cont	: * * *
Date y/m/d	: 01/01/01
Time h/m/s	: 00:00:00
Printer(pc)set	: 9600
USB out	: OFF

Item	Default	Contents
● Meas Mode	: Normal	: Normal : Normal measurement Print : Print PC out : Data management Memory Call : Display recorded data L <sub>Atm5</sub> : Tact-max sound pressure level (STD card) Remote U : Communicate mode(USB) Remote R : Communicate mode(RS-232C)
● Data delet	: Off	: Data deletion mode setting Off : Date deletion is disabled Fixed to OFF in Peak mode 3sec : Data in past 3 sec is deleted when [Pause] key is pressed during the measurement. 5sec : Data in past 5 sec is deleted when [Pause] key is pressed during the measurement . ※The function is disabled for Meas Time 1, 3 or 5 sec,.
● LCD cont	: *****	: Adjustment of LCD contrast See “LCD adjustment” section for the details.
● Date y/m/d	: 00/01/01	: Calendar setting (date: 2000/01/01) See “Calendar adjustment” for the details.
● Time h/m/s	: 00:00:00	: Time setting See the “Calendar adjustment” for the details.
● Printer(PC) set: 9600		: Baud rate setting USB Communicate: 9600、 19200 RS-232C Communicate(remote communication) : 9600、 19200、 38400 RS-232C Communicate (When automatic power supply ON measurement starts) : 4800、 9600、 38400
● USB out		: Digital data output setting OFF → L <sub>p</sub> → L <sub>pB</sub> → Wave (Outputs data from USB out in parallel with the measurement.) OFF ; USB output is disabled. L <sub>p</sub> ; Outputs instantaneous value in each second L <sub>pB</sub> ; Outputs level data in each band when the octave filter is used. The 1/1, 1/3 Oct real-time analysis card(NA-0038) is necessary. Wave ; Outputs level data in each band at sampling rate 48kHz when the octave filter is used.

<Memory>(2/3)

<b>&lt;Memory&gt;</b>		<b>2/3</b>
<b>Mode</b>	:	<b>Normal</b>
<b>Interval</b>	:	<b>Single</b>

Select to  
Mode:Auto



<b>&lt;Memory&gt;</b>		<b>2/3</b>
<b>Mode</b>	:	<b>Auto</b>
<b>Interval</b>	:	<b>Single</b>
<b>I/O</b>	:	<b>OFF</b>
<b>Level</b>	:	<b>65dB</b>
<b>Samp Time</b>	:	<b>Meas Time</b>
<b>Sta</b>	:	<b>08/10/10 18:16:00</b>
<b>Stp</b>	:	<b>08/10/12 20:16:00</b>



Select to  
Mode:Start

<b>&lt;Memory&gt;</b>		<b>2/3</b>
<b>Mode</b>	:	<b>Start</b>
<b>Interval</b>	:	<b>Repeat</b>
<b>I/O out</b>	:	<b>232C</b>

<u>Items</u>	<u>Default</u>	<u>Explanation</u>
• Mode	: Normal	: Normal : Basic setting Auto : Automatic measurement, where the following items are available. Start : Start of power supply ON automatic measuring system. (It records on the memory card simultaneously)
• Interval	: Single	: Measuring interval setting Single : The measurement starts with [Start/Stop] key and is terminated at Meas Time selected . Repeat : The measurement starts with [Start/Stop] key and is repeated in every Meas Time selected until [Start/Stop] key is pressed.

【When Mode:Auto is selected, the following items can be specified】

• I/O	: OFF	: External output setting OFF : Default (Data output is disabled). ON : Outputs data for one second when the data memory mode is active.
• Level	: 65dB	: 65dB : Threshold level is registered (when the level exceeds it, recording starts), within the range 20-130dB at resolution 1dB
• Samp Time	: Meas Time	: Meas Time : sampled at interval equal to Meas time. 100ms : sampled at interval 100ms (0.1s). 200ms : sampled at interval 200ms (0.2s). 1s : sampled at interval 1s

\*\* Meas Time is time set with [Meas Time] key (1s~····).

**Fixed to Mease Time, when when RSR card is installed.**

\* Select 10s or more in L<sub>Atm5</sub> measurement.

• Sta	:	Registers the starting time for recording (YY/MM/DD HH/MM/SS) (Year/Month/Date, date time/minute/second).
• Stp	:	Registers the stop time for recording (YY/MM/DD HH/MM/SS) (Year/Month/Date, date time/minute/second).

**NOTE**

Measurement starts when the selected level is exceeded after the time specified with **Sta Time**, In the following example :

: When the level exceeds 65dB after 18:16 October 10,  
Recording starts and the measurement is made once during  
the time specified with **Meas Time**.  
Recording is continued, in Interval Repeat mode, until the  
level falls or until 20:16 October 12,.  
Data is shown according to System Mode.

**【When Mode:Start is selected, the following items can be specified】**

- I/O : 232C : Selection of interface.  
232C : RS-232C  
USB : USB

※The following items become fixation (It is not possible to change).

<p><b>&lt;System&gt; 1/3</b></p> <p><b>Mode</b> : Normal ← Fixation</p> <p><b>Data delete</b> : off ← Fixation</p> <p><b>LCD cont</b> : * * * * *</p> <p><b>Date y/m/d</b> : 01/01/01</p> <p><b>Time h/m/s</b> : 00:00:00</p> <p><b>Printer(pc)set</b> : 4800</p> <p><b>USB out</b> : OFF ← Fixation</p>	<p><b>&lt;Memory&gt; 2/3</b></p> <p><b>Mode</b> : Start ← Fixation</p> <p><b>Interval</b> : Repeat ← Fixation</p> <p><b>I/O out</b> : 232C</p>
<p><b>&lt;View Mode&gt; 3/3</b></p> <p><b>Lp</b> : INST</p> <p><b>(A)View</b> LA05 : OFF</p> <p>LAeq : ON LA10 : OFF</p> <p>LAE : OFF LA50 : OFF</p> <p>L Amin : ON LA90 : OFF</p> <p>L Amax : ON LA95 : OFF</p>	<p style="text-align: right;">} Fixation</p>

- Level Range : 20~100dB (Fixation)
- Time weighting : Fast (Fixation)
- Frequency weighting : A (Fixation)

**NOTE**

- When Start is selected, it becomes a measurement beginning in **[Start/Stop]** key input or power supply ON of this equipment.
- When Start is selected, the operation result is recorded on the memory card every set time of "Meas.Time".
- When Start is selected, cards other than the memory card cannot be used. Please change to modes other than Start when you use other cards.  
When optional card is inserted after this power supply ON of this equipment : **[Card]** key invalid operation  
At this equipment power supply ON after inserting an optional card : **[Card]** key invalid operation or "Card ERR" is displayed.
- The RS-232C/USB output is continuously output though the card record stops at that time when the record of the memory card becomes FULL while measuring it. In this case, please copy data in the memory card to the personal computer etc. once, and execute the deletion of the data file of the memory card from this equipment.

<View Mode> 3/3

Select the category of displayed data.

The data registered here is displayed in the standard screen, one by one with [Mode] key pressed on the main body.

<b>&lt;View Mode&gt;</b>		<b>3/3</b>
<b>Lp</b>	<b>: INST</b>	
<b>(A)View</b>	<b>LA05</b>	<b>: OFF</b>
<b>LAeq</b>	<b>: ON</b>	<b>LA10 : OFF</b>
<b>LAE</b>	<b>: OFF</b>	<b>LA50 : OFF</b>
<b>L Amin</b>	<b>: ON</b>	<b>LA90 : OFF</b>
<b>L Amax</b>	<b>: ON</b>	<b>LA95 : OFF</b>

<u>Items</u>	<u>Default</u>	<u>Explanation</u>
• L	:INST	:INST :Data is displayed in each second TACT :The maximum level is displayed in one second. (TACT MAX)

- Lp : Instantaneous value
- Leq : Equivalent continuous A-weighted sound pressure level
- LE : Single event sound exposure level
- Lmin : Minimum A-weighted sound pressure level
- Lmax : Maximum A-weighted sound pressure level
- Lpeak : Peak sound pressure level

In each [Mode] key pushed in the measurement screen, display changes as follows :

- LA→Leq→LE→Lmin→Lmax→L05→L10→L50→L90→L95
- When TACT is selected for Lp, [LaT] is displayed in display mode.

<Display> When Lp is TACT

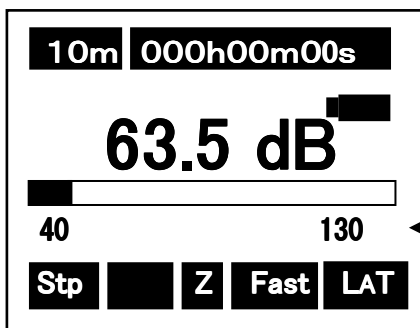

Display mode  
In the case of Lp : TACT  
Z : LpT  
A : LAT  
C : LcT

## Measurement Procedure

### Sound pressure level ( $L_p$ ) measurement : Frequency weighting key Z

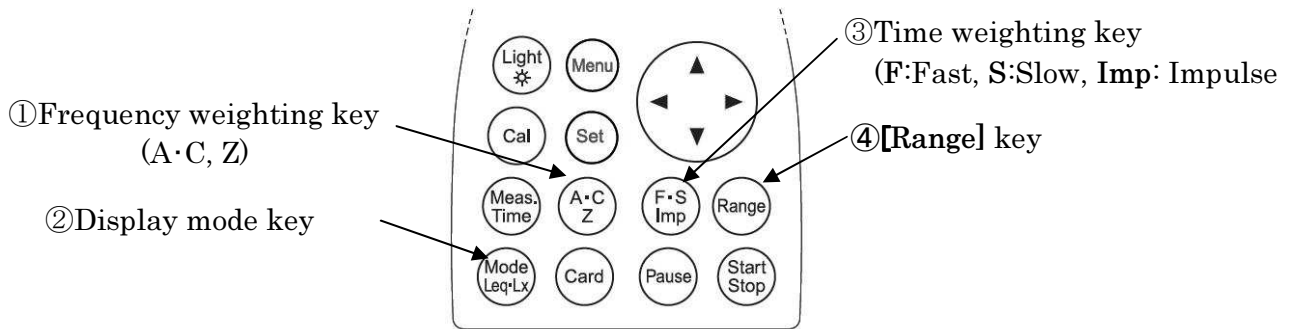

#### < Parameter setting >

Measurement is made according to the following procedure.

- ① Frequency weighting key : Z
- ② Display mode key :  $L_p$
- ③ Time weighting key : F, S or Imp
- ④ Range key : Select a range where the bar graph indicates approximately 2/3 of the full scale.

#### 【Method of selecting RangeKey】

Press [Range] key, and choose by cursor keys  $\blacktriangle$   $\blacktriangledown$ , and press [Range] key again to register.

#### < Display >

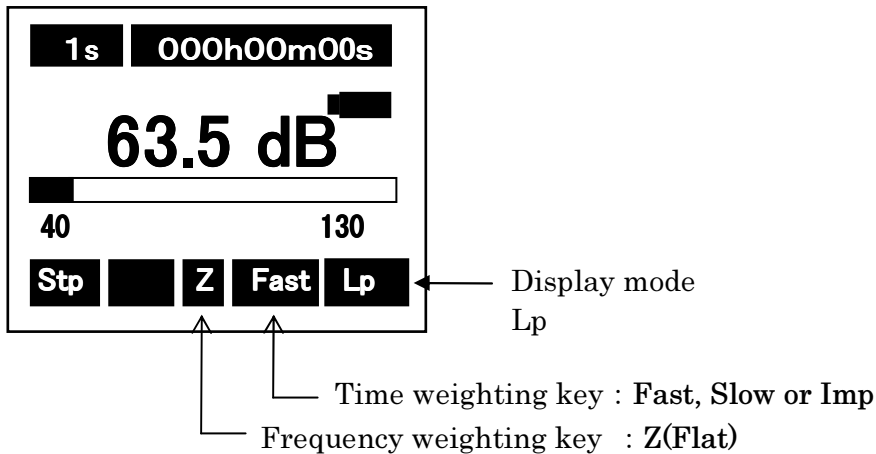

## Temporal level display of Sound pressure level (Lp)

### < Parameter setting > :

The temporal level is displayed at each contiguous push (1.5s) of [Mode] key as follows, returning to the standard display screen when the key is pushed again.

The key operation is similar to the measurement of sound pressure level (Lp).

### < Display >

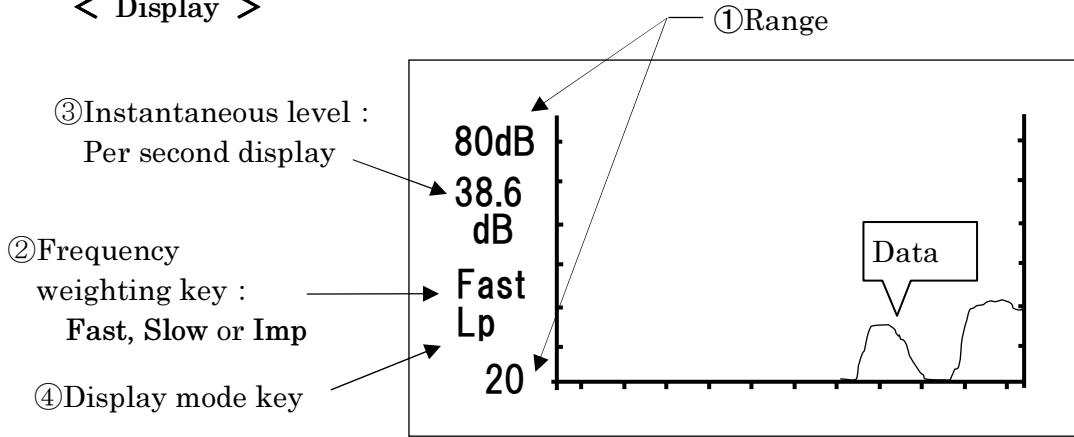

The instantaneous level is displayed at each about 300ms from right to left.

## Data hold

By pushing the [Pause] key, the blinking letter "Pause" is displayed at the center of the bar graph, displaying the present instantaneous level. Note that the bar graph itself doesn't pause.

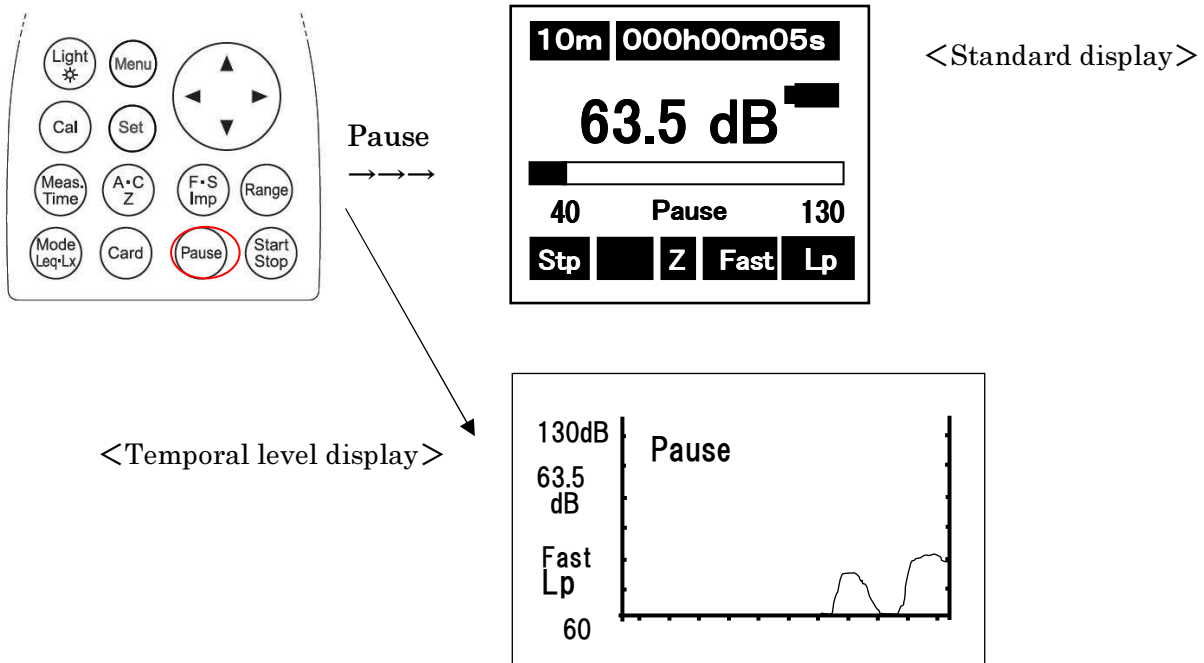

· By pushing the [Pause] key is pushed again, it is released.

# A-weighted sound pressure level (LA/LC) measurement : Frequency weighting key A, C

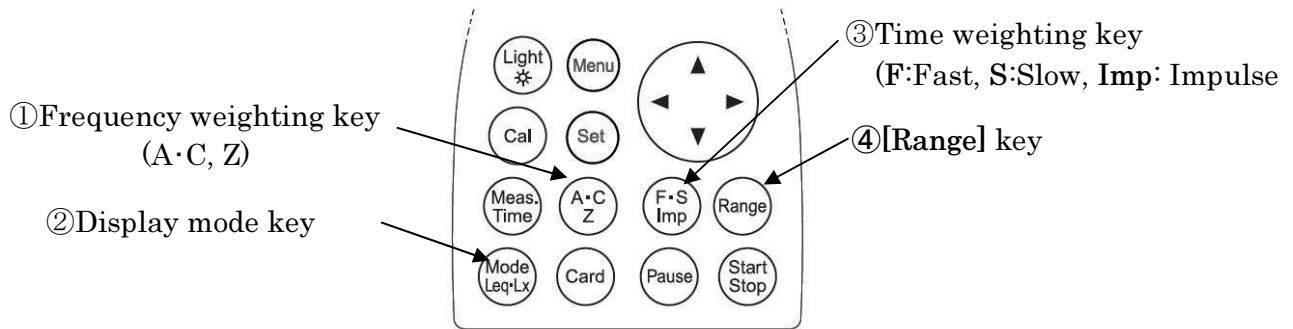

## < Parameter setting >

Measurement is made according to the following procedure

- ① Frequency weighting key : A or C
- ② Display mode key : LA , LC
- ③ Time weighting key : F, S or Imp
- ④ Range key : Select a range where the bar graph indicates approximately 2/3 of the full scale.

### 【Method of selecting [Range] key】

Press [Range] key, and choose by cursor keys▲▼, and press [Range] key again to register.

## < Display >

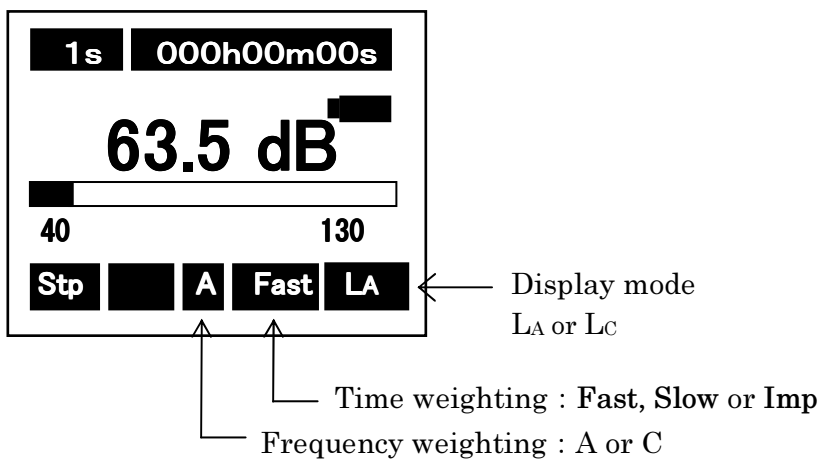

## Time level display of A-weighted sound pressure level (LA/LC)

### < Parameter setting >

The key operation is similar to the measurement of A-weighted sound pressure level (LA/LC).

### < Display >

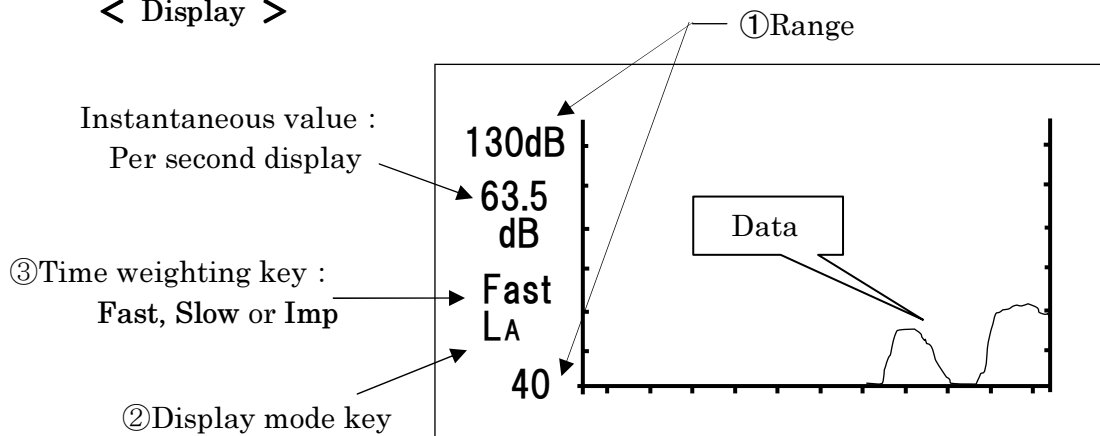

The instantaneous level is displayed at each about 300ms from right to left.

### Data hold

By pushing the [Pause] key, the blinking letter “Pause“ is displayed at the center of the bar graph, displaying the present instantaneous level. Note that the bar graph itself doesn't pause.

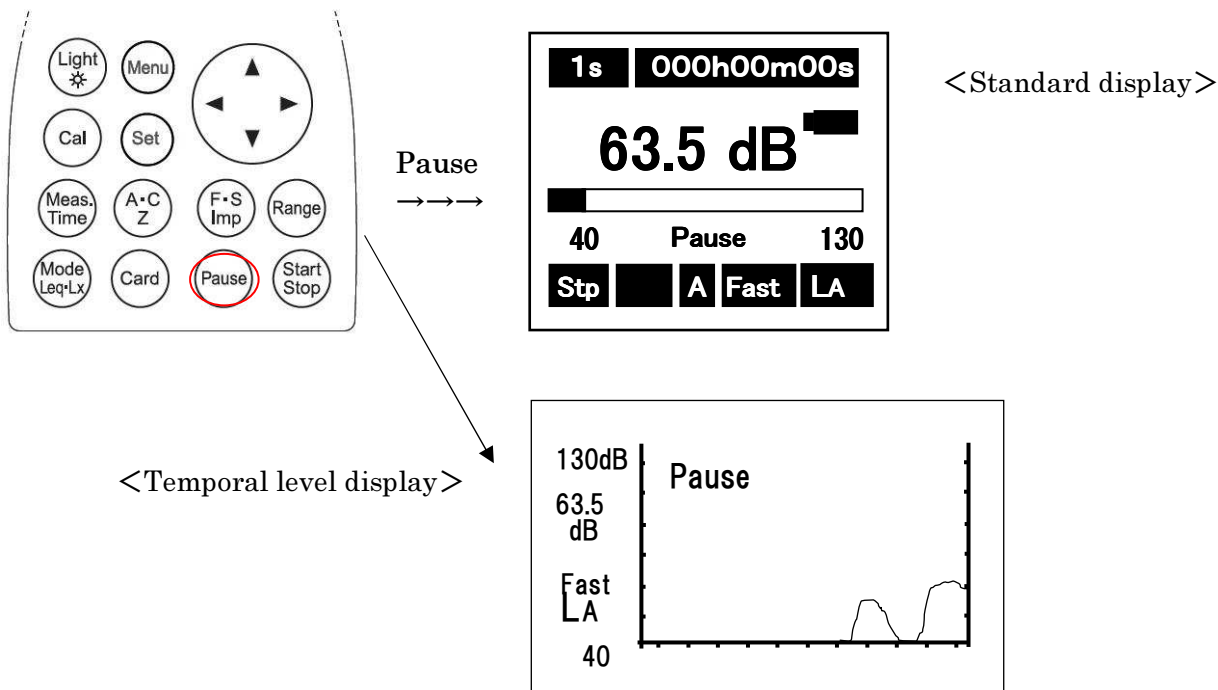

• By pushing the [Pause] key again, it is released.



# Equivalent continuous A-weighted sound pressure level (LAeq) measurement

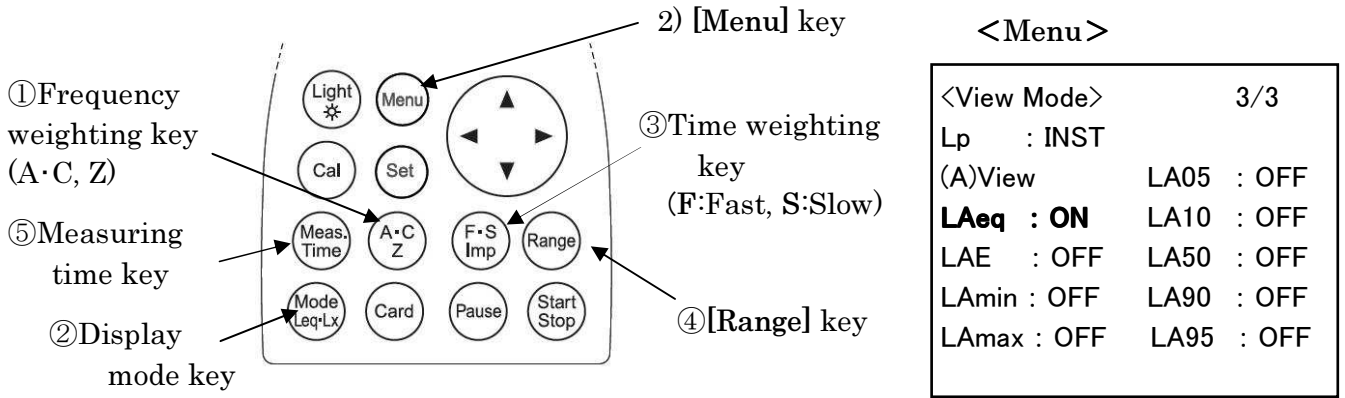

## < Parameter setting >

- 1) The key operation is similar to the measurement of A-weighted sound pressure level (LA) except that it needs [Start/Stop] key input for starting the measurement (automatic calculation).
- 2) To display the value Leq, keep the "LAeq" key ON in advance in the <View Mode> 3/3 screen.
  - ① Frequency weighting key : A
  - ② Display mode key : Leq
  - ③ Time weighting key : F or S
  - ④ Range key : Select a range where the bar graph indicates approximately 2/3 of the full scale.

### 【Method of selecting [Range] Key】

Press [Range] key, and choose by cursor keys▲▼, and press [Range] key again to register.

- ⑤ Measurement time key : 1s, 3s, 5s, 10s, 1m, 5m, 10m, 15m, 30m, 1h, 8h, 24h and \* \* \* (until the [Start/Stop] key pushed again)

## < Display > Measurement

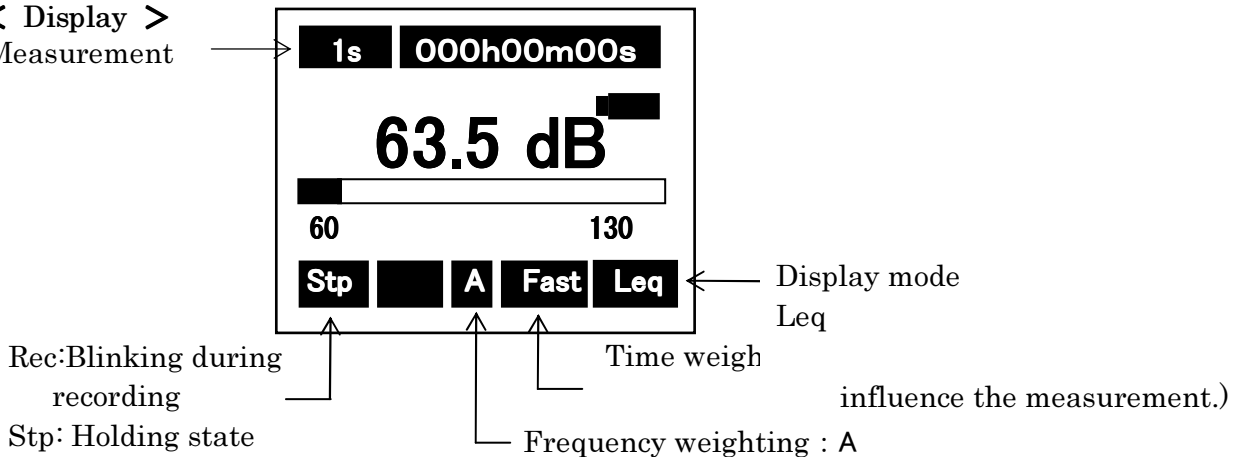

- Measurement starts with [Start/Stop] key pushed, and ends up automatically at the measurement time. Digital display indicates the halfway result at the current point of time. (Display "Rec" blinks while the measurement.)
- When Interval is set to Repeat in <Memory> 2/3 screen, the measurement is repeated in every measurement time. (This is used when continuous measurement is needed.)
- By pushing [Start/Stop] key in course of the measurement, calculation is done using the data so far.
- By pushing [Pause] key in course of the measurement, the calculation can be done without using the data in the latest 3 or 5 seconds.
- To set this function, see the description of data delete in "Section 4 Menu 2.Menu(1/2)". This function can be set in the Data delete in the <System> 1/3 screen.
- When \*\*\* is selected, the final data is calculated and displayed only when [Start/Stop] key is pushed or 199 hours have gone through.
- All the keys do not respond during the measurement : [Start/Stop], [Mode], [Light]

# Single event sound exposure level ( $L_{AE}$ ) measurement

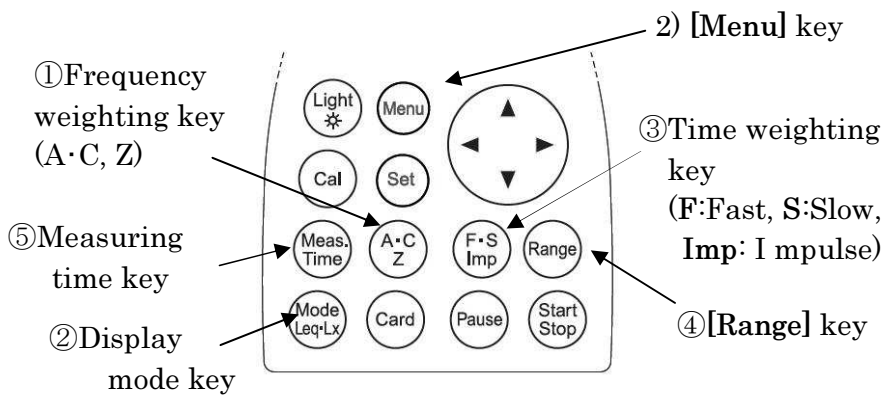

<Menu>

<View Mode>	3/3
Lp	: INST
(A)View	LA05 : OFF
LAeq	: OFF LA10 : OFF
<b>LAE</b>	: <b>ON</b> LA50 : OFF
L Amin	: OFF LA90 : OFF
L Amax	: OFF LA95 : OFF

## < Parameter setting >

- 1) The key operation is similar to the measurement of A-weighted sound pressure level ( $L_A$ ) except that it needs [Start/Stop] key input for starting the measurement (automatic calculation).
- 2) To display measurements of  $L_{AE}$ , input ON to "LAE" beforehand by the Menu item.
  - ①Frequency weighting key : A
  - ②Display mode key :  $L_E$
  - ③Time weighting key : Any of F, S or Imp (doesn't influence the measurement.)
  - ④[Range] key : Select a range where the bar graph indicates approximately 2/3 of the full scale.

### [Method of selecting [Range] key]

Press [Range] key, and choose by cursor keys  $\blacktriangle$  $\blacktriangledown$ , and press [Range] key again to register.

- ⑤Measurement time key : 1s, 3s, 5s, 10s, 1m, 5m, 10m, 15m, 30m, 1h, 8h, 24h and \* \* \* (to the [Start/Stop] key)

## < Display >

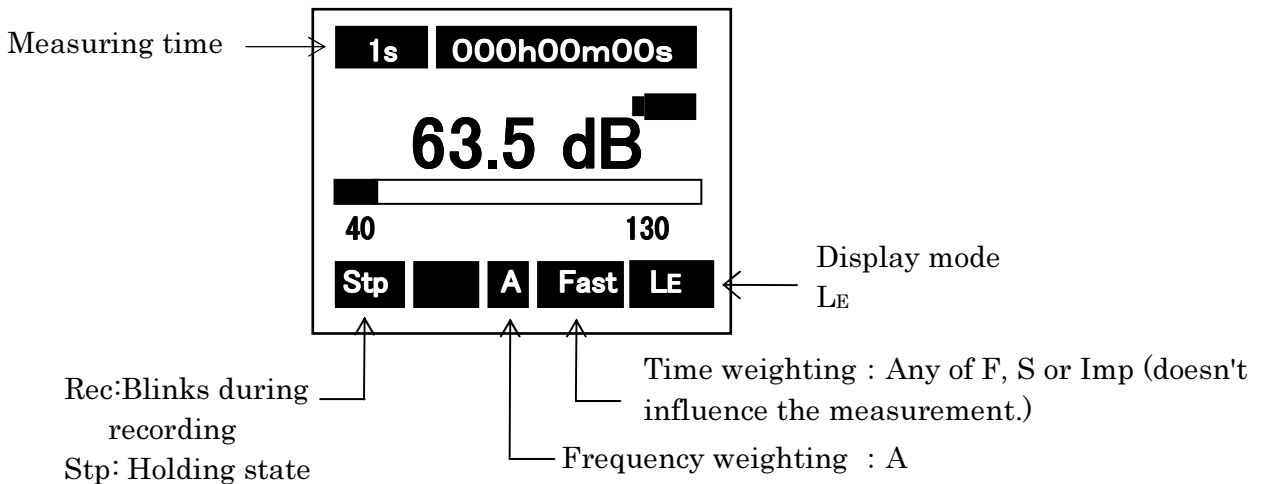

- The measurement is similar to the equivalent continuous A-weighted sound pressure level ( $L_{Aeq}$ ).

# Maximum A-weighted Sound pressure Level ( $L_{Amax}/L_{Amin}$ ) Measurement

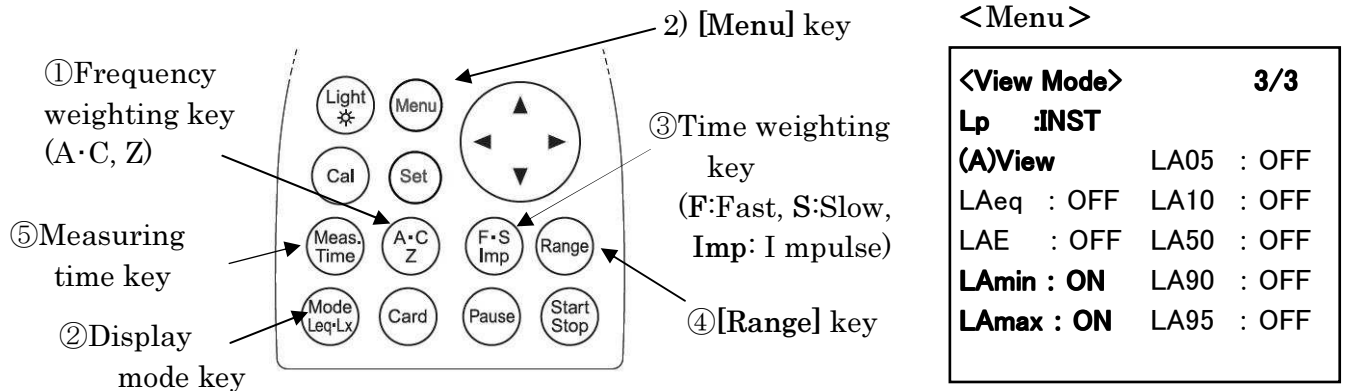

## < Parameter setting >

1) The key operation is similar to the measurement of A-weighted sound pressure level ( $L_{Aeq}$ )

To display measurements of  $L_{max}$ , input ON to "LAmax" beforehand by the <View Mode> 3/3 screen item.

(similar in  $L_{min}$  measurement.)

- ① Frequency weighting key : A
- ② Display mode key :  $L_{max}$  or  $L_{min}$
- ③ Time weighting key : Fast or Slow
- ④ Range key : Select a range where the bar graph indicates approximately 2/3 of the full scale.

### [Method of selecting [Range] key]

Press [Range] key, and choose by cursor keys  $\blacktriangle$   $\blacktriangledown$ , and press [Range] key again to register.

- ⑤ Measurement time key : 1s, 3s, 5s, 10s, 1m, 5m, 10m, 15m, 30m, 1h, 8h, 24h and \* \* \* (to the [Start/Stop] key)

## < Display >

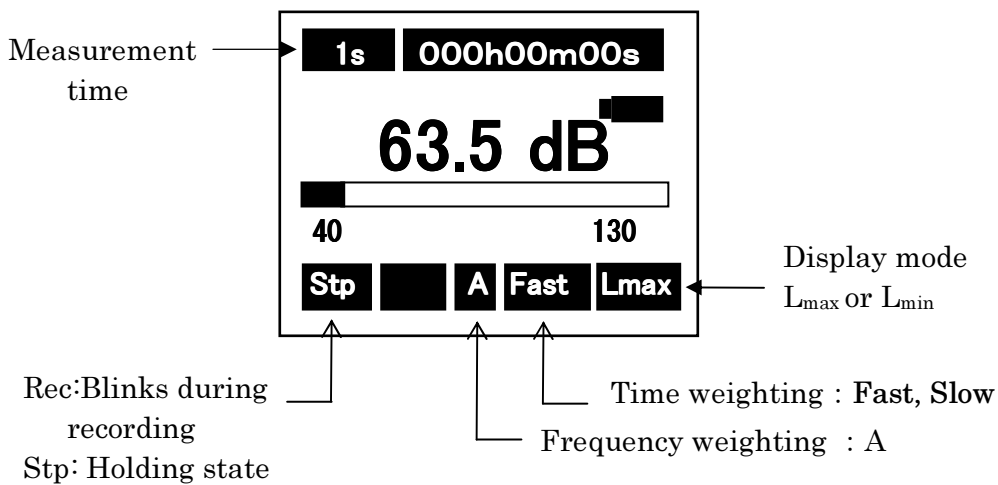

## Percentile level (L<sub>AN</sub>) measurement

① Frequency weighting key (A·C, Z)

② [Menu] key

③ Time weighting key (F:Fast, S:Slow, Imp: I mpulse)

④ [Range] key

⑤ Measuring time key

② Display mode key

<Menu>

<View Mode> 3/3

Lp :INST

(A)View LA05 : ON

LAeq : OFF LA10 : ON

LAE : OFF LA50 : ON

LAmin : OFF LA90 : ON

LAmax : OFF LA95 : ON

### < Parameter setting >

- 1) The key operation is similar to the measurement of A-weighted sound pressure level (LAeq)
- 2) To display the value L<sub>max</sub>, keep the "LA05 ,LA10 ,LA50 ,LA90 ,LA95" key ON in advance in the <View Mode> 3/3 screen.

- ① Frequency weighting key : A
- ② Display mode key : L<sub>N</sub> (To display the Percentile level (L<sub>N</sub>) Measurement.)
- ③ Time weighting key : Fast or Slow
- ④ Range key : Select a range where the bar graph indicates approximately 2/3 of the full scale.

#### [Method of selecting [Range] Key]

Press [Range] key, and choose by cursor keys ▲▼, and press [Range] key again to register.

- ⑤ Measurement time key : 1s, 3s, 5s, 10s, 1m, 5m, 10m, 15m, 30m, 1h, 8h, 24h and \* \* \* (input to the [Start/Stop] key)

### < Display >

Measuring time

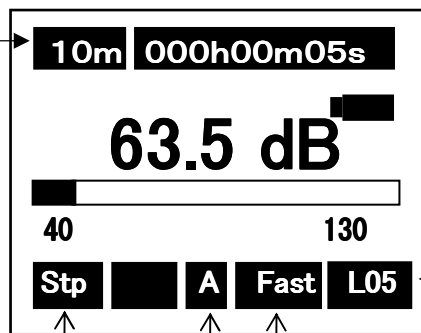

NOTE

The L<sub>N</sub> computation is made at sampling rate 100msec, which tends to influence the accuracy in the condition of measuring time less than 10sec.

Display mode  
L05 ,L10 ,L50 ,L90 ,L95

Rec: Blinks during recording  
Stp: Halting state

Time weighting : Fast, Slow  
Frequency weighting : A

## Peak sound pressure level ( $L_{peak}$ ) measurement

The peak sound pressure level is peak sound pressure level of the sound wave before smoothed with the time weighting characteristics.

$L_{peak}$  is peak sound level for Z characteristics.

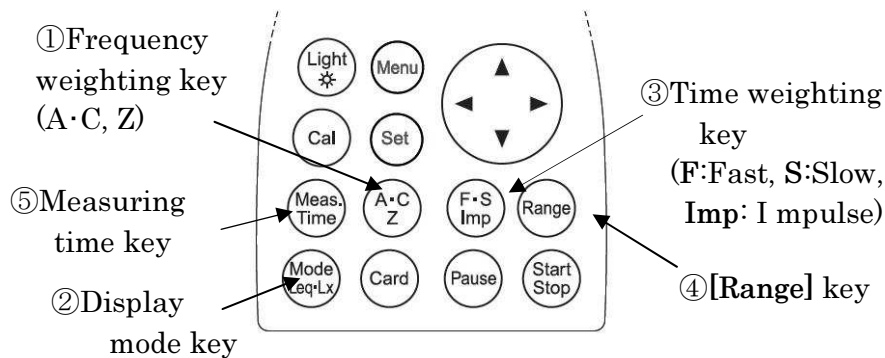

### < Parameter setting >

Measurement is made according to the following procedure

- ① Frequency weighting key : Z
- ② Display mode key : Peak
- ③ Time weighting key : F, S or Imp
- ④ Range key : Select a range where the bar graph indicates approximately 2/3 of the full scale.

#### [Method of selecting [Range] key]

Press [Range] key, and choose by cursor keys▲▼, and press [Range] key again to register.

- ⑤ Measurement time key : 1s, 3s, 5s, 10s, 1m, 5m, 10m, 15m, 30m, 1h, 8h, 24 h
- ⑥ and \* \* \* (input to the [Start/Stop] key)

### < Display >

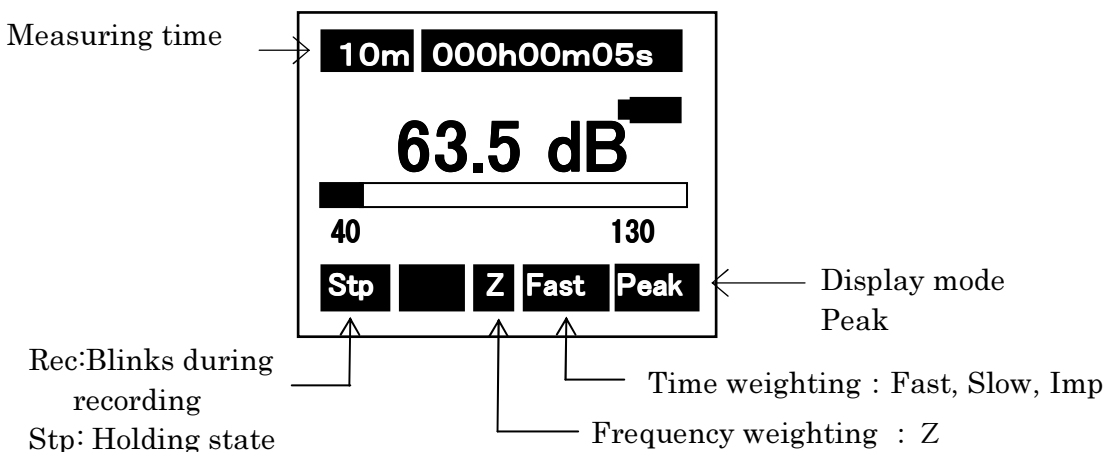

## C-weighted peak sound pressure level ( $L_{Cpeak}$ ) measurement

The peak sound level is peak sound pressure level before smoothed with the time weighting characteristics.

$L_{Cpeak}$  is wavy peak level of C characteristic.

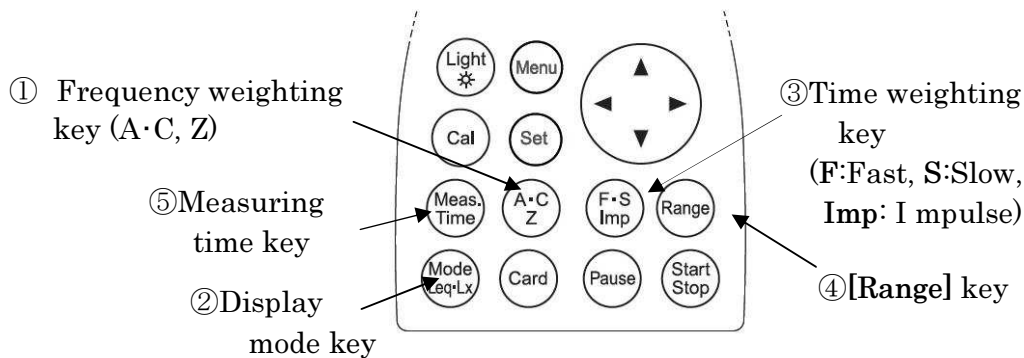

### < Parameter setting >

Measurement is made according to the following procedure

- ① Frequency weighting key : C
- ② Display mode key : Fixed to Peak
- ③ Time weighting key : Any of F, S or Imp  
(doesn't influence the measurement.)
- ④ Range key : Select a range where the bar graph indicates approximately 2/3 of the full scale.

#### [Method of selecting [Range] key]

Press [Range] key, and choose by cursor keys  $\blacktriangle$   $\blacktriangledown$ , and press [Range] key again to register.

- ⑤ Measurement time key : 1s, 3s, 5s, 10s, 1m, 5m, 10m, 15m, 30m, 1h, 8h, 24h and \* \* \* (input to the [Start/Stop] key)

The measurement starts with [Start/Stop] key.

### < Display >

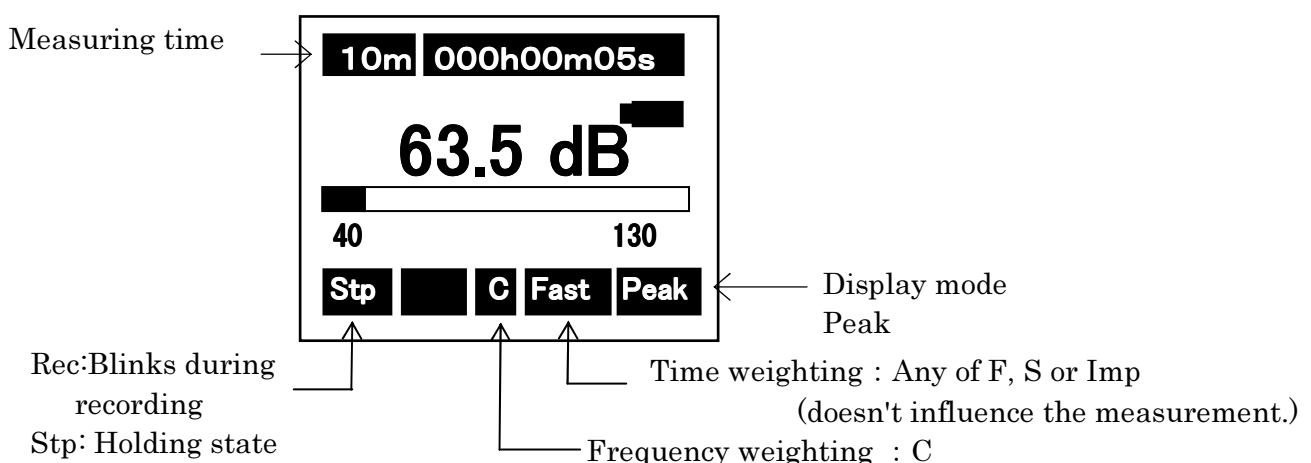

- Measurement starts with [Start/Stop] key pushed, and ends up automatically at the measurement time. Digital display indicates the halfway result at the current point of time. (Display "Rec" blinks while the measurement.)
- By pushing [Start/Stop] key in course of the measurement, calculation is done using the data so far.
- When \*\*\* is selected, the final data is calculated and displayed only when [Start/Stop] is pushed or 199 hours have gone through.

# C-weighted equivalent continuous sound pressure level ( $L_{Ceq}$ ) measurement

$L_{Ceq}$  is C-weighted equivalent continuous sound pressure level.

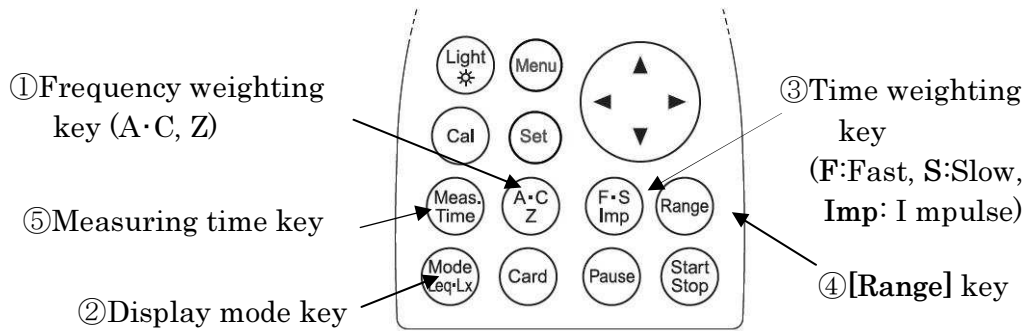

## < Parameter setting >

Measurement is made according to the following procedure

- ① Frequency weighting key : C
- ② Display mode key : Leq
- ③ Time weighting key : F or S
- ④ Range key : Select a range where the bar graph indicates approximately 2/3 of the full scale.

### 【Method of selecting [Range] key】

Press [Range] key, and choose by cursor keys▲▼, and press [Range] key again to register.

- ⑤ Measurement time key : 1s, 3s, 5s, 10s, 1m, 5m, 10m, 15m, 30m, 1h, 8h, 24h and \* \* \* (input to the [Start/Stop] key)

The measurement starts with [Start/Stop] key.

## < Display >

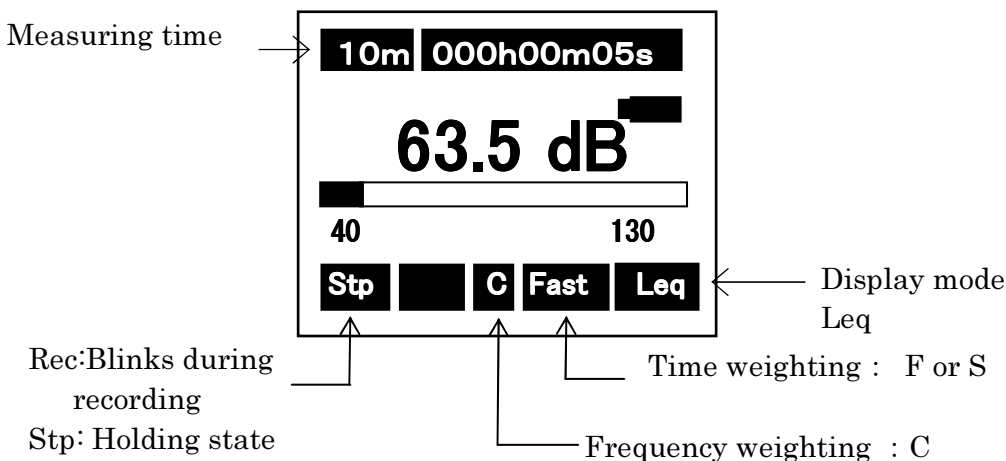

# Power average value of the maximum sound pressure level in a given interval ( $L_{Atm5}$ ) measurement

Power average value of the maximum sound pressure level in a given interval ( $L_{Atm5}$ ) is power average of the maximum value of A-weighted sound pressure level in successive 5-sec intervals. It can be measured only when A characteristics is selected in the standard screen.

1) [Menu] key

① Frequency Weighting key

② Display mode

③ Time weighting key (F:Fast, S:Slow, Imp: I mpulse)

④ [Range] key

<Menu>

<System>	1/3
Mode	LAtm5
Data delet	: off
LCD cont	: * * *
Date y/m/d	: 01/01/01
Time h/m/s	: 00:00:00
Printer(pc)set	: 9600
USB out	: OFF

## < Parameter setting >

Mode: Normal in < System>1/3 screen is changed to Mode: $L_{Atm5}$  with the  $\blacktriangle\blacktriangledown$  key in Menu screen. The screen for power average of the maximum value appears when the change is fixed and resisted with [Set] key.

### 【Method of selecting [Range] key】

Press [Range] key, and choose by cursor keys  $\blacktriangle\blacktriangledown$ , and press [Range] key again to register.

Measurement is made according to the following procedure

- ① Frequency weighting key : A
- ② Display mode key :  $L_A$  or  $tm5$
- ③ Time weighting key : F or S
- ④ Range key : Select a range where the bar graph indicates approximately 2/3 of the full scale.
- ⑤ Measurement time key : 1s, 3s, 5s, 10s, 1m, 5m, 10m, 15m, 30m, 1h, 8h, 24h and \* \* \* (input to the [Start/Stop] key)

The measurement starts with [Start] key.

< Display >

Measurement time 10s (second) display

```

00h00m00s
00h00m01s
00h00m02s
.
00h00m09s ← End in ten seconds
00h00m00s ← The following measurement
    
```

\* When <Memory>2/3 screen Intr:Single is measured, it becomes Repeat continuous work as the measurement time display.

Bar: Displays the current instantaneous level.

$L_A$  or  $tm5$

Press [Start/Stop Set] key

← Count-up timer for the measurement

← Starts with display  $\text{---.---}$  when the measurement mode is  $tm5$ . Measurement value is displayed every five second.

← The bar displays the instantaneous level in every 0.1 second.

←  $L_A$  and  $tm5$  can be changed.

Current level is displayed with  $L_A$  selected value.

The Rec blinks with [Start/Stop] key input



## Impulse sound pressure level( $L_{AI}$ ) measurement

Impulse sound pressure level ( $L_{AI}$ ) is A-weighted sound pressure level with time weighting characteristics, 'Impulse'.

It can be used only when A characteristics is selected in the default screen.

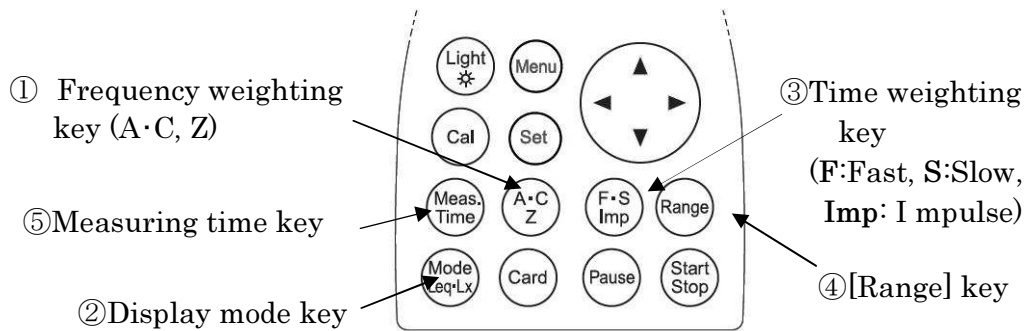

### < Parameter setting >

Measurement is made according to the following procedure

- ① Frequency weighting key : A
- ② Display mode key :  $L_A$
- ③ Time weighting key : Imp
- ④ Range key : Select a range where the bar graph indicates approximately 2/3 of the full scale.

#### 【Method of selecting [Range] key】

Press [Range] key, and choose by cursor keys  $\blacktriangle$   $\blacktriangledown$ , and press [Range] key again to register.

### < Display >

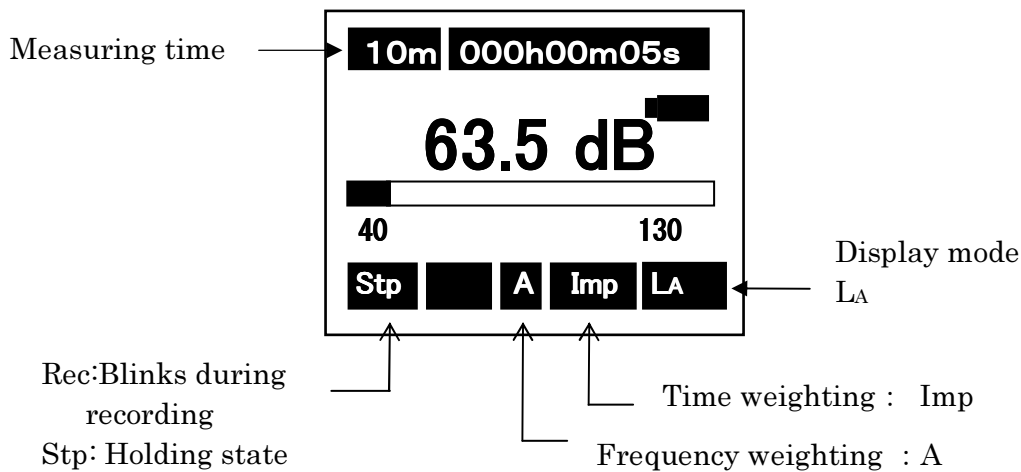

## Impulse equivalent continuous A-weighted sound pressure level ( $L_{A_{Leq}}$ ) measurement

Impulse equivalent continuous A-weighted sound pressure level ( $L_{A_{Leq}}$ ) is equivalent continuous sound pressure level with time weighting characteristics, 'Impulse'.

It can be used only when A characteristics is selected in the default screen.

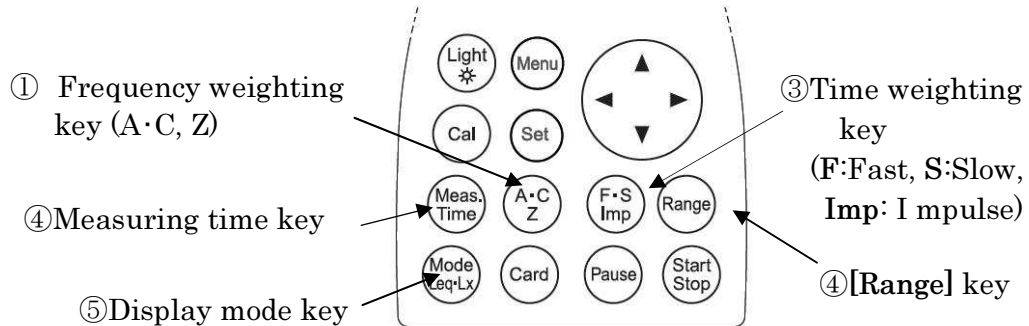

### < Parameter setting >

Measurement is made according to the following procedure

- ① Frequency weighting key : A
- ② Display mode key : Leq
- ③ Time weighting key : Imp
- ④ Range key : Select a range where the bar graph indicates approximately 2/3 of the full scale.

#### 【Method of selecting [Range] key】

Press [Range] key, and choose by cursor keys▲▼, and press [Range] key again to register.

### < Display >

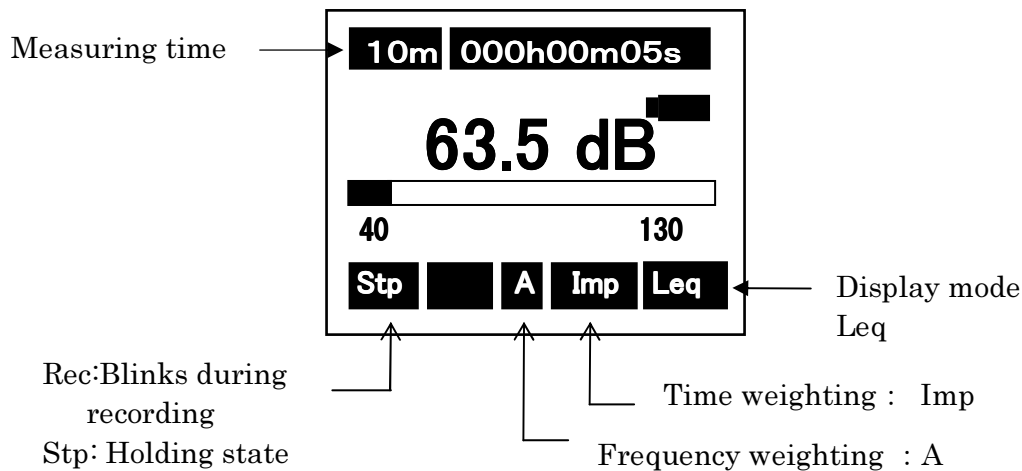

## Memory function

### Record of memory

**【Normal】** mode

<b>&lt;Memory&gt;</b>	<b>2/3</b>
<b>Mode</b>	<b>: Normal</b>
<b>Interval</b>	<b>: Single</b>

Mode : Normal  
● Interval : Single

: Normal : Normal measurement

: Measuring interval setting

Single : The measurement starts with **[Start/Stop]** key and is terminated at Meas Time selected .

Repeat : The measurement starts with **[Start/Stop]** key and is repeated in every Meas Time selected until **[Start/Stop]** key is pressed.

**【Auto】 mode**

< Operation >

By changing Mode: Normal in < Memory>2/3 of [Menu] screen to Mode: Auto with the ▲▼key , and fixing it with [Set] key, the following screen appears:

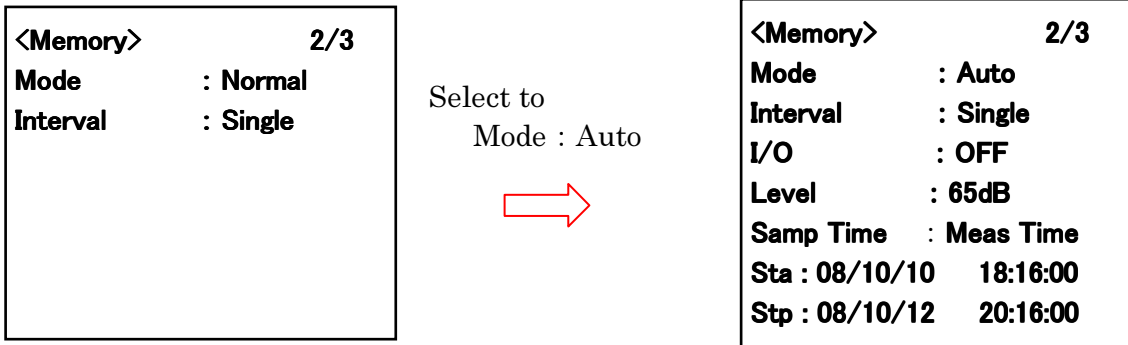

- Mode : Auto : Automatic measurement, where the following items are available.
  - Interval : Single : Measuring interval setting
    - Single : The measurement starts with [Start/Stop] key and is terminated at Meas Time selected .
    - Repeat : The measurement starts with [Start/Stop] key and is repeated in every Meas Time selected until [Start/Stop] key is pressed.
  - I/O : OFF : External output setting
    - OFF : Default (Data output is disabled).
    - ON : Outputs data for one second when the data memory mode is active.
  - Level : Threshold level is registered (when the level exceeds it, recording starts)
  - Samp Time : Meas Time : Meas Time : sampled at interval equal to Meas time.
    - 100ms : sampled at interval 100ms (0.1s).
    - 200ms : sampled at interval 200ms (0.2s).
    - 1s : sampled at interval 1s
- \*\* Meas Time is time set with [Meas Time] key (1s~····).

Fixed to Mease Time, when when RSR card is installed,

\* Select 10s or more in L<sub>Atm5</sub> measurement.

- Sta : Registers the starting time for recording (YY/MM/DD HH/MM/SS)  
(Year/Month/Date, date time/minute/second).
- Stp : Registers the stop time for recording (YY/MM/DD HH/MM/SS)  
(Year/Month/Date, date time/minute/second)

<The internal SRAM and Memory Card(SD Card) The contents of the record>

Set value of Samp Time	Style	A	C	Z	
100ms 200ms 1s	Sound pressure level	L <sub>A</sub>	L <sub>C</sub>	L <sub>p</sub>	
Meas Time	Equivalent continuous sound pressure level	L <sub>Aeq</sub>	L <sub>Ceq</sub>	—	
	Sound exposure level	L <sub>AE</sub>	—	—	
	Maximum sound pressure level	L <sub>Amax</sub>	—	—	
	Minimum sound pressure level	L <sub>Amin</sub>	—	—	
	Percentile sound pressure level (L <sub>AN</sub> )	Percentile (5%) sound pressure level	L <sub>A05</sub>	—	—
		Percentile (10%) sound pressure level	L <sub>A10</sub>	—	—
		Percentile (50%) sound pressure level	L <sub>A50</sub>	—	—
Percentile (90%) sound pressure level		L <sub>A90</sub>	—	—	
Peak sound pressure level		—	L <sub>Cpeak</sub>	L <sub>peak</sub>	

«Interval : Single At time of setting»

- Samp Time : Meas.Time at time of setting

If instantaneous value is beyond a set point, I record for once of “Meas.Time”.

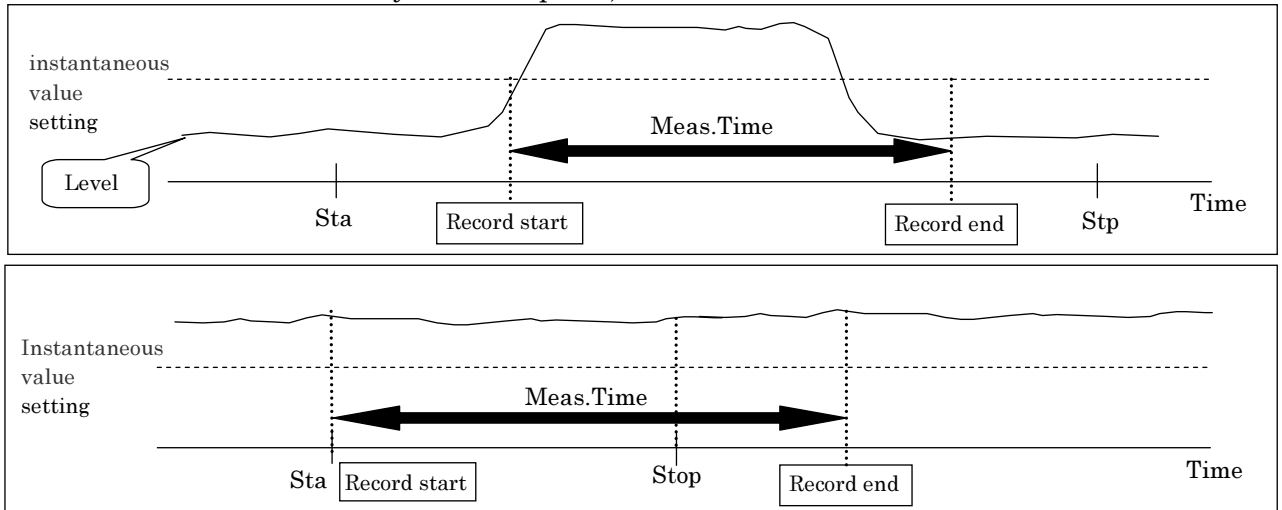

- Samp Time :( 100ms / 200ms / 1s ) at time of setting

If instantaneous value is beyond a setting level, record it during one second by setting time of Samp Time ( 100ms / 200ms / 1s ).

When there is no memory card (SD card): 1S and the record are one data at the measurement time for the sampling duration of the setting.

When there is a memory card (SD card): 1S and the record are the numbers at the measurement time for a set sampling duration of one second.

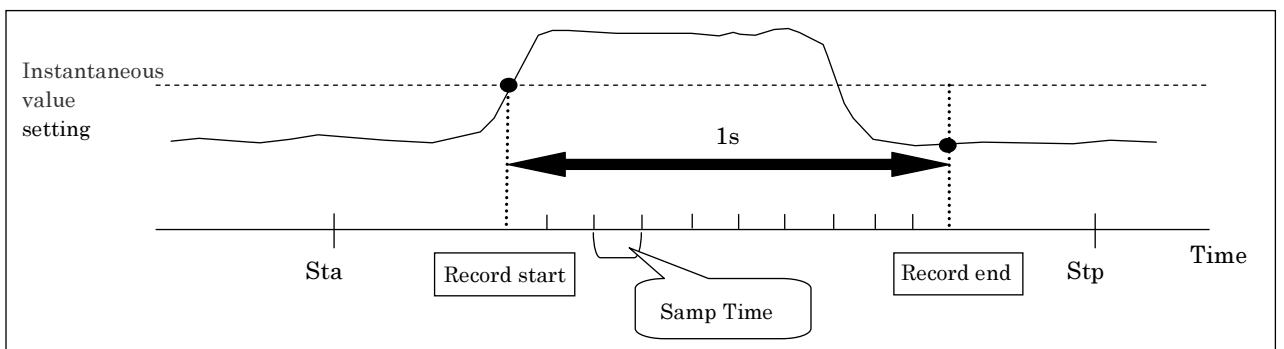

«Interval : Repeat At time of setting»

Level of instantaneous value is less than a setting level or records it until record stop time.

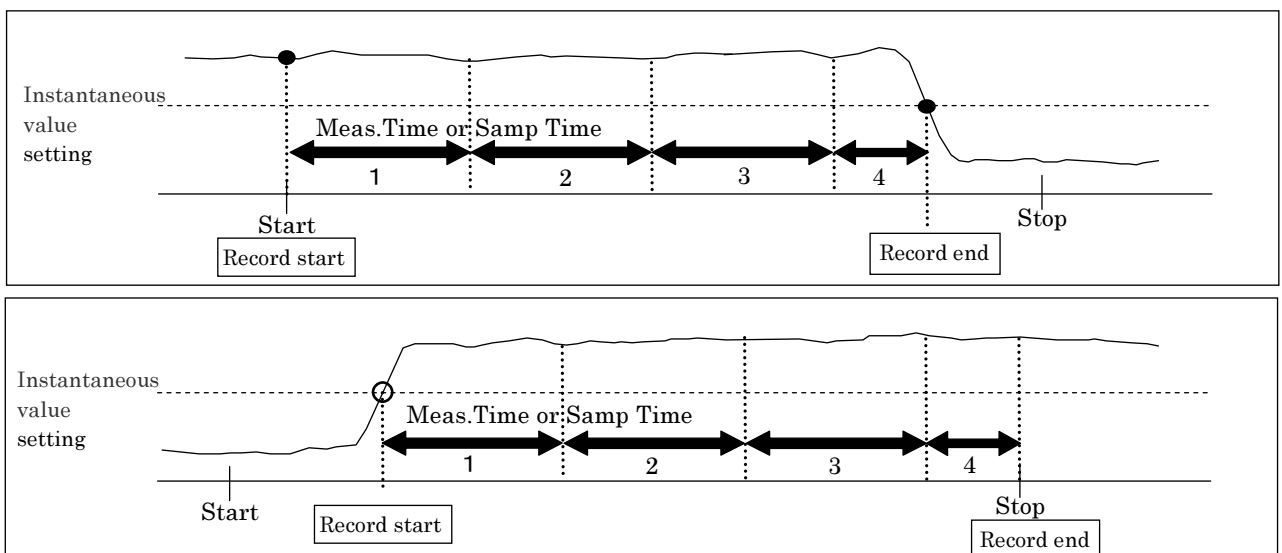

< Standby screen >

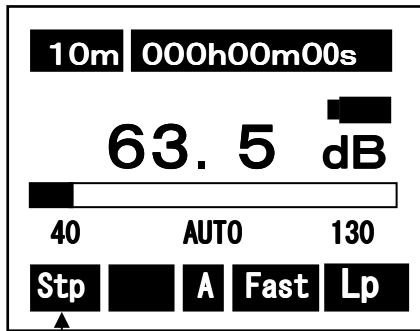

< During a measurement >

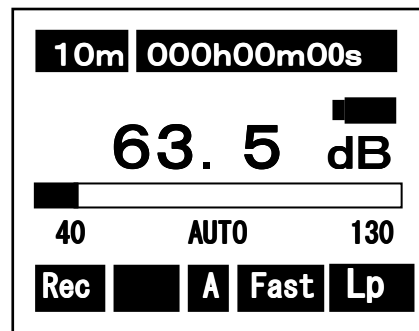

↑  
Default screen

The Stp blinks when [Start Stop] Key is pressed to confirm the stand-by state.

# Data recall from the memory

<Operation>

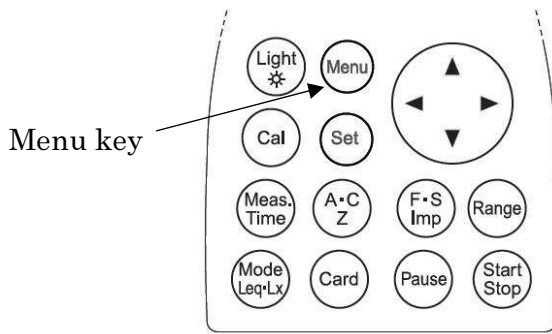

<System>	1/3
Mode	Mem call
Data delet	: off
LCD cont	: * * *
Date y/m/d	: 01/01/01
Time	: 00:00:00
Printer(pc)set	: 9600
USB out	: OFF

The Mode: Normal in <System>1/3 screen is changed to Mode: Mem call with ▲▼key, which then leads to the memory display screen by pressing [Set] key. .

【external Memory Card (SD card)】 【internal SRAM】

<p>001/014 10m 08/10/10 FAST * 2:18:20 LAeq : 45.3 LA05 : 66.2 LAE : 48.6 LA10 : 66.2 LA50 : 66.2 Lmin : 42.2 LA90 : 66.2 Lmax : 77.5 LA95 : 66.2 Memory Call Ex</p>	<p>001/014 10m 08/10/10 FAST 12:18:20 LAeq : 45.3 LA05 : 66.2 LAE : 48.6 LA10 : 66.2 LA50 : 66.2 Lmin : 42.2 LA90 : 66.2 Lmax : 77.5 LA95 : 66.2 Memory Call IN</p>	<p>Memory number, Sampling time</p> <p>Date/time of the Measurement</p> <p>Time constant</p> <p>Symbol *** refers to the item which is set OFF in Menu screen.</p> <p>Display blinks</p>
--	---	--

\*\*\* is displayed in Repeat of the external Memory Card (SD Card)

The first data of Repeat data are displayed.

Each data is displayed with ◀▶ key at Repeat.

Select the data with ▲▼ key, accelerating by keeping on pushing the cursor

On pressing Card key in the state of Memory Call, it changes to Memory Call Ex and the data in the Card is displayed

Memory Call IN : Data stored in the internal SRAM.

Memory Call Ex : Date stored in the external Memory Card (SD Card)

[Start/Stop] key pressed starts data communication displayed data.

※To return to the default screen, change Mode: Memory call in < System>1/3 screen to Mode :Normal with ▲▼ key.

NOTE
Whenever measuring it, the measurement data preserved in an internal memory is overwritten.

## How to use the Memory Card ( SD Card –Standard– )

The measured data can be stored on the memory card (SD card) to be processed by personal computer. When the memory card (SD card) is inserted after the POWER of this equipment supply is turned on, display【STD】blinks. The memory card (SD card) is recognized automatically, blinks STD is a standby display on starting the measurement if the power switch is turned on with the memory card (SD card) inserted.

### Card Installation



① Insert the a card.

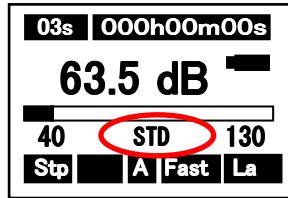
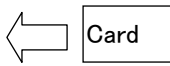

②STD lighted.

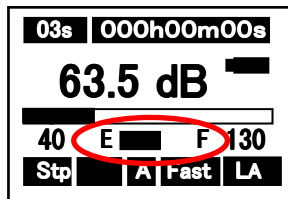

④The remaining card capacity displayed.

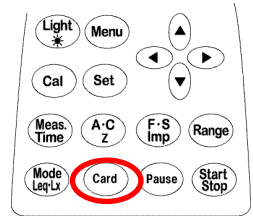

③Press [Card] key.

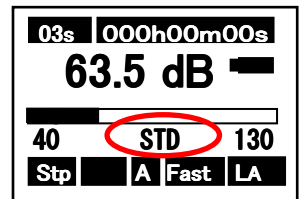

After 3s

⑤Blinks STD is a standby display on starting the measurement.

### Measurement

<E.g. Acquired data to be stored in CSV format.>

Single :

Press  
[Start/Stop] key

Ref. Measurement  
Procedure

Measur day	time	weight	Range	Time set	LAeq	LAE	Lmin	
2009/04/13	18:17:10	F	80dB	000h00m03s	49.8	54.6	40	...

Repeat :

easur day	time	weight	Range	Time set	LAeq	LAE	Lmin	
2009/04/13	18:17:10	F	80dB	000h00m03s	49.8	54.6	40	...
2009/04/13	18:17:13	F	80dB	000h00m03s	56.6	61.3	47.4	...
2009/04/13	18:17:16	F	80dB	000h00m03s	66	70.7	51.9	...
.	.	.	.	.	.	.	.	.
.	.	.	.	.	.	.	.	.
.	.	.	.	.	.	.	.	.



## Eject the card

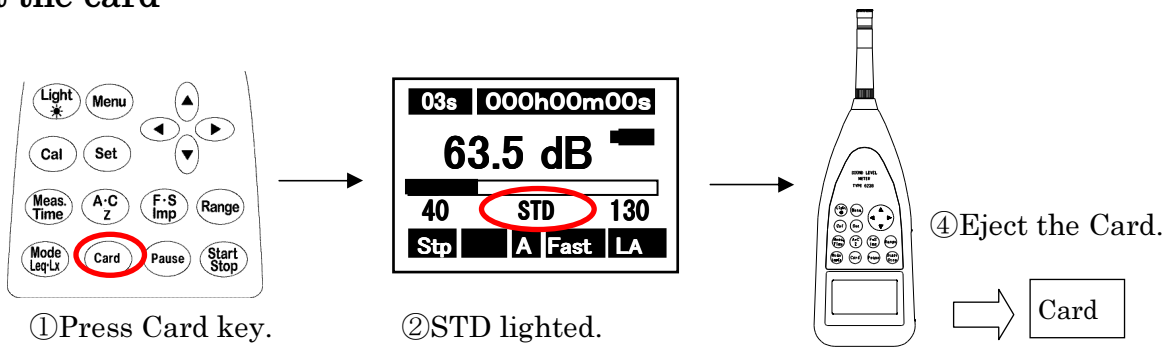

**⚠ CAUTION**

After "STD" lighting, please take out a card in a few minutes.  
There is the case that "Card ERR" is displayed. In the case, the file might be damaged.

## Delete the card data

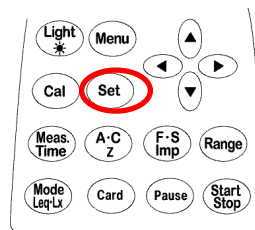
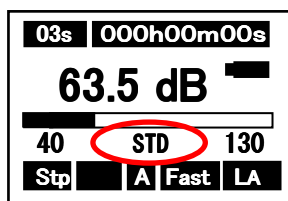

① Confirm STD blinking.

② Keep [Set] key pushed for a few seconds in the situation with the card installed.

**Data all Clear**  
Yes = Start  
No = Set



**Sure ?**  
Yes = Start  
No = Set

③ Delete all the data along the displayed flow of operation, then to return to the former window.

## Example of file creation

The file is created as follows. :

When A characteristics (Time constant F and S) is selected:

• Single

001.csv ← : Whenever [Start/Stop] key is pushed, this single data line is made. (a single data since the mode is Single. )

002.csv ↓

Meas...day/Meas...time/Time weight/Level Range/Time sett/LAeq/Lmin...../LA95
2009/03/2 9:54:52 F 80dB 000h...10s 48.9 42.3 43.9

• Repeat

001.csv ← : Whenever [Start/Stop] key is pushed, this data line is made. (two or more data/file)

002.csv ↓

Meas...day /Meas...time/Time weight/Level Range/Time sett/LAeq/Lmin...../LA95
2009/03/2 9:54:52 F 80dB 000h...10s 48.9 42.3 43.9
2009/03/2 9:54:52 F 80dB 000h...10s 48.9 42.3 43.9
2009/03/2 9:54:52 F 80dB 000h...10s 48.9 42.3 43.9
•
• < as many data lines as indicated by Repaet >
2009/03/2 9:54:52 F 80dB 000h...10s 48.9 42.3 43.9

Eventually, in the card, Single and Repeat data files are created at random.

< Example >

001.csv ← : File made in single mode (1 data/ 1file)

002.csv ← : File made in single mode (1 data/ 1file)

003.csv ← : File made in repeat mode (two or more data/file)

004.csv ← : File made in single mode (1 data/ 1file)

005.csv ← : File made in repeat mode (two or more data/file)

•

•

↑ At most 999 CSV files can be made, where [Start/Stop] key is pressed 999 times..

Only LA<sub>1eq</sub> is made.

Meas...day /Meas...time/Time weight/Level Range/Time sett/LA <sub>1eq</sub>
2009/03/2 9:54:52 I 80dB 000h...10s 52.3
2009/03/2 9:54:52 I 80dB 000h...10s 52.3
2009/03/2 9:54:52 I 80dB 000h...10s 52.3
•
• < as many data lines as indicated by Repaet >
2009/03/2 9:54:52 I 80dB 000h...10s 52.3

## Print/Data management

### Print

This equipment is provided with a function of printing the measured data with a specified serial printer.

```

<System> 1/3
Mode      Print
Data delet : off
LCD cont  : * * *
Date y/m/d : 01/01/01
Time h/m/s : 00:00:00
Printer(pc)set : 9600
USB out   : OFF
    
```

← Set to  
Mode: Print

#### <Parameter setting>

- 1) Turn off POWER switch and connect the printer before turning on POWER switch again.
- 2) Select Print in [Menu] key, < System > 1/3 screen and press [Set] key.
- 3) Then, the following screen appears.

#### <Display>

Number of data of memory numbers

A-weighting	C-weighting	Z-weighting
<div style="display: flex; justify-content: space-between;"> <span>001/014</span> <span>10m</span> <span>08/10/10</span> </div> <p>FAST 12:18:20</p> <p>LAeq : 45.3 LA05 : ***.*</p> <p>LAE : 48.6 LA10 : 66.2</p> <p style="padding-left: 100px;">LA50 : ***.*</p> <p>Lmin : 42.2 LA90 : ***.*</p> <p>Lmax : 70.5 LA95 : ***.*</p> <p>■ Print IN</p>	<div style="display: flex; justify-content: space-between;"> <span>001/014</span> <span>10m</span> <span>08/10/10</span> </div> <p>FAST 12:18:20</p> <p>Lceq : 63.3</p> <p>Lcpeak : 71.3</p> <p>■ Print IN</p>	<div style="display: flex; justify-content: space-between;"> <span>001/014</span> <span>10m</span> <span>08/10/10</span> </div> <p>FAST 12:18:20</p> <p>Lpeak : 72.9</p> <p>■ Print IN</p>

Display blinks

#### <Manner of operation of data>

elect the data with ▲▼key, accelerating by keeping on pushing the cursor.

On pressing [Card] key in the state of Print, it changes to Print Ex and the data in the Card is displayed

Memory Call IN : Data stored in the internal SRAM.

Memory Call Ex : Date stored in the external Memory card (SD Card)

Print (date communication) starts with the top of the data by pushing the [Start/Stop] key.

Printing can be paused with [Pause] key and restarted by pressing it again from the current data line. .

The printing is canceled by pressing [Start/Stop] key and stands by at the top data display screen.

## Saving Data to PC

This equipment is provided with data saving function using the specified data management software.

Data management with USB port

```

<System> 1/3
Mode : PC out
Data delet : off
LCD cont : * * *
Date y/m/d : 01/01/01
Time h/m/s : 00:00:00
Printer(pc)set : 9600
USB out : OFF
    
```

← Set Mode to PC out display

<Operation>

Select PC out in [Menu] key, < System > 1/3 screen and press [Set] key.

<Display>

Number of data of memory numbers

A-weighting	C-weighting	Z-weighting
001/014 10m 08/10/10 FAST 12:18:20 LAeq : 45.3 LA05 : ***.* LAE : 48.6 LA10 : 66.2 LA50 : ***.* Lmin : 42.2 LA90 : ***.* Lmax : 70.5 LA95 : ***.* Print IN	001/014 10m 08/10/10 FAST 12:18:20 Lceq : 63.3 Lcpeak : 71.3 Print IN	001/014 10m 08/10/10 FAST 12:18:20 Lpeak : 72.9 Print IN

Display blinks

<Manner of operation of data>

Select the data with ▲▼key, accelerating by keeping on pushing the cursor

On pressing [Card] key in the state of Print, it changes to Print Ex and the data in the Card is displayed

Memory Call IN : Data stored in the internal SRAM.

Memory Call Ex : Date stored in the external Memory Card (SD\_Card)

Date communication starts with the top of the data by pushing [Start/Stop] key.

Printing can be paused with [Pause] key and restarted by pressing it again from the current data line. .

The printing is canceled by pressing [Start/Stop] key and stands by at the top data display screen.

## Output terminal

### AC、DC Output

#### AC Output

The AC Output is the frequency-weighted signal.

Output: 1Vrms (FS), Output impedance: 600Ω, Load impedance > 10kΩ

#### DC Output

The DC Output is the frequency-weighted, root-mean-square-detected, and then logarithmic converted signal.

Output: 2.5V (FS), 0.25V/10dB, Output impedance: 50Ω, Load impedance > 10kΩ

Relation between the display value of each range, and output voltage

DISPLAY VALUE (dB)						OUTPUT VOLTAGE (V)	
RANGE						AC OUT	DC OUT
40~130	30~120	20~110	20~100	20~90	20~80		
130	120	110	100	90	80	1.00000	2.50000
120	110	100	90	80	70	0.31623	2.25000
110	100	90	80	70	60	0.10000	2.00000
100	90	80	70	60	50	0.03162	1.75000
90	80	70	60	50	40	0.01000	1.50000
80	70	60	50	40	30	0.00316	1.25000
70	60	50	40	30	20	0.00100	1.00000
60	50	40	30	20	—	0.00032	0.75000
50	40	30	20	—	—	0.00010	0.50000
40	30	20	—	—	—	0.00003	0.25000



- 18) Calibration signal : Electric calibration with internal oscillator  
(1kHz sine wave)
- 19) Outputs      AC output      :  $\phi$  2.5 Jack  
                  Output            : 1Vrms (FS)  
                  Output impedance : 600  $\Omega$   
                  Load impedance  : more than 10k  $\Omega$   
                  DC output        :  $\phi$  2.5 Jack  
                  Output            : 2.5V (FS), 0.25V/10dB,  
                  Output impedance : 50  $\Omega$   
                  Load impedance  : more than 10k  $\Omega$
- 20) RMS detection circuit : True RMS detection circuit (computing type)
- 21) Processing            : Digital
- 22) Pause                 : Normal pause function, as well as the function of canceling the data before pausing the measurement, are available.
- 23) Data Storage Functions : Sound pressure level or Processed values stored in built-in Memory or Memory card
- Manual Storage : Sound level, Calculation value, Memory time, Store the Sampling Time to Built-in memory or on Memory card
- Auto Storage    : Sampling interval 100ms, 200ms, sound level , Leq etc.
- Processing Card : Storage of calculation results
- 24) I/O                    : Direct output to printer, control and output data to computer  
                                  Digital output of real-time noise waveform with USB interface
- 25) Comparator Output    : Comparator Function with threshold level
- 26) Battery Type            : Four 1.5V Alkaline cells IEC type LR6,  
                                  Optional AC adapter
- Battery life        : Alkaline dry cell ; Approx.9 hours when Switch on a back light ;  
                                  Approx.1/3
- Consumption current : Approx.150mA (When input 6V) at Calculation OFF.  
                                  When AC adaptor is used ; Approx.2.6VA
- 27) Operating temperature : -10~50°C 30%~90%RH (no condensation)
- 28) Size                    : 86(W)  $\times$  285(H)  $\times$  46(D)
- 29) Weight                 : Less than Approx.450g (Including batteries)
- 30) Option
- 1/1 and 1/3-octave Real-time Analysis Card
- Applicable standards : JIS C 1514 (IEC61260) : Class1
- Measurement mode    : Sound pressure level (Lp), Equivalent continuous Sound pressure level (Leq), Sound exposure level(L<sub>E</sub>), Maximum sound pressure level (L<sub>max</sub>)  
(One of the measurement modes selected as above is displayed.)

Frequency analysis band : 1/1- octave filter ; 16Hz, 31.5 Hz, 63 Hz, 125 Hz, 250 Hz,  
500Hz, 1kHz, 2kHz,4kHz, 8kHz, AP  
1/3- octave filter ; 12.5Hz, 16Hz, 20 Hz,25 Hz,31.5Hz,40Hz,  
50Hz, 63Hz, 80Hz, 100Hz, 125Hz, 160Hz,  
200Hz, 250Hz, 315Hz, 400Hz, 500Hz,  
630Hz, 800Hz, 1kHz, 1.25kHz, 1.6kHz,  
2kHz, 2.5kHz, 3.15kHz, 4kHz, 5kHz,  
6.3kHz,8kHz,10kHz ,12.5kHz, 16kHz, AP

- FFT Analysis Card

Frequency span : 2kHz、 5kHz、 10kHz、 20kHz  
Time window : Rectangular、 Hanning  
Analysis line : 400  
Zoom : ×1, ×2, ×4  
Processing : Sound pressure level, Linear average value, Max,

- RSR card (Real sound recording card)

This card enables automatic recording with specified level and time, namely adding the function of recording real wave data.

The data is recorded in WAVE file format (48kHz 16bit Mono), easily corresponding to most common application software of acoustic analysis, as well as displaying its greatest force in all kinds of acoustic analysis.

Time for continuous record : Approx.6 hours



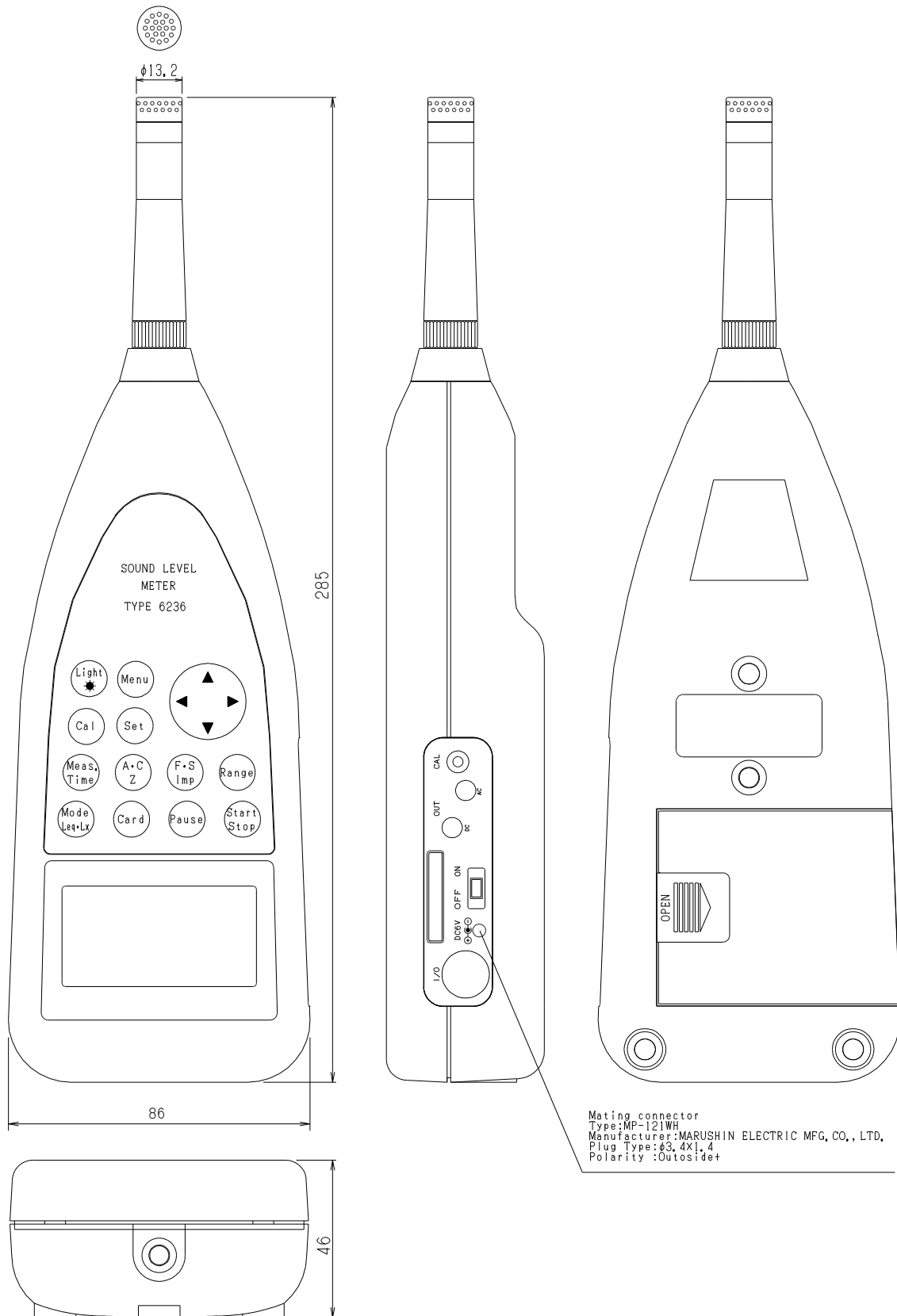

Appearance diagram of Sound Level Meter MODEL 4431

## Pin Connections and How to Connect the Extension cable

1) Detach microphone from the body of the meter.

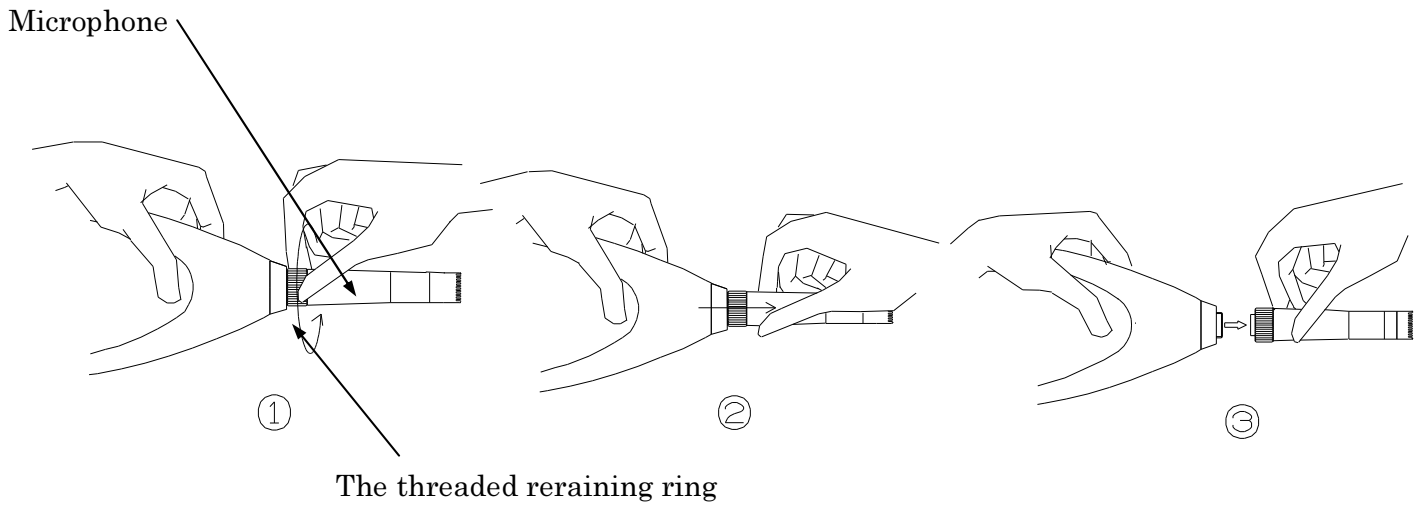

- ① Turn the threaded retaining ring a little to the left.
- ② Pull out microphone as shown.
- ③ Repeat ① turn a left and ② pull out a little 5-8 times and you can separate.

2) Then plug the male connector of extension cable into the connector of the body.

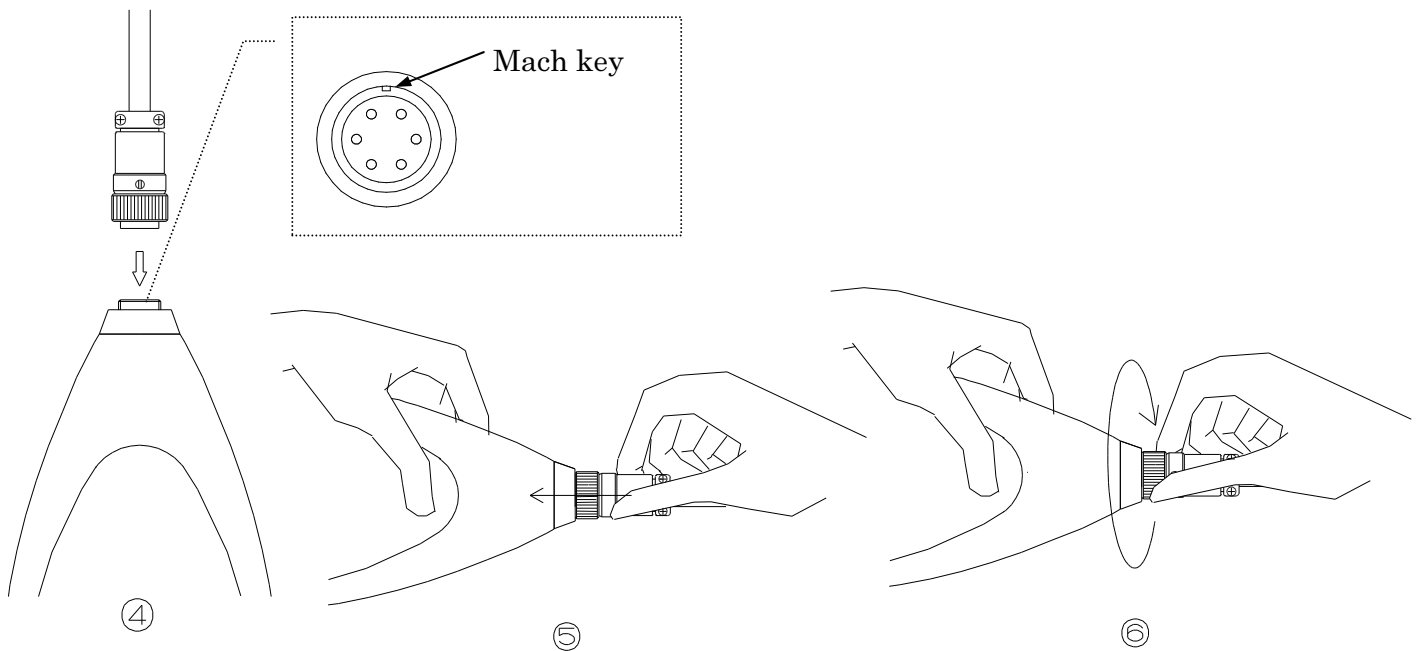

- ④ Mach key groove of body's connector with the connector of extension cable and insert.
- ⑤ Push the connector of extension cable.
- ⑥ Turn the threaded retaining ring a little as shown repeat ⑤ and ⑥ 5-8 times and you can connect.

3) Attach microphone to the female connector of extension cable.

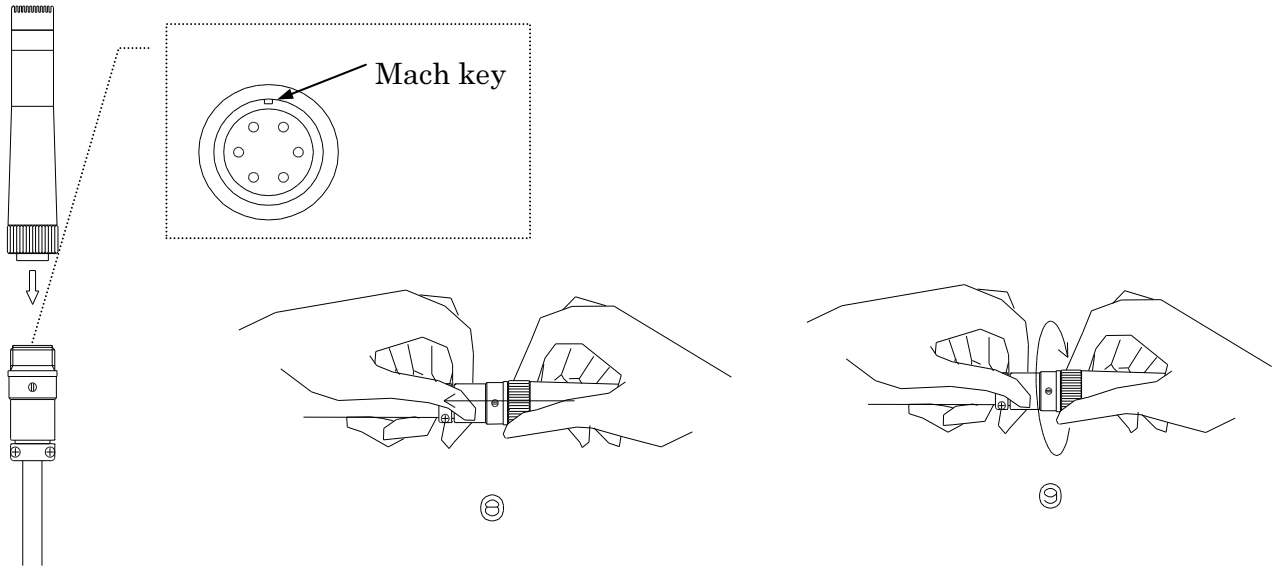

- ⑦ Mach key groove of body's connector with the connector of extension cable and insert.
- ⑧ Push the connector of extension cable.
- ⑨ Turn the threaded retaining ring a little as shown repeat ⑧ and ⑨ 5-8 times and you can connect.

※ Note; Do not turn only the threaded retaining ring connecting.  
It causes damage to the connector.

【Wiring diagram of Main body side connector】

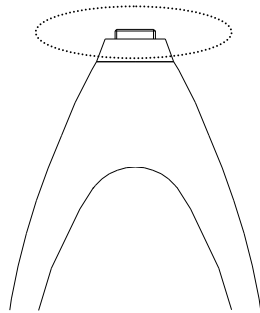

Connector (Soket;Type R03-R6F)

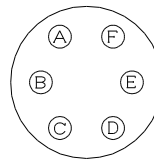

A ; +6.5V      E ; NC  
B ; NC          F ; SIG  
C ; -6.5V  
D ; GND

【Wiring diagram of Extension cable】

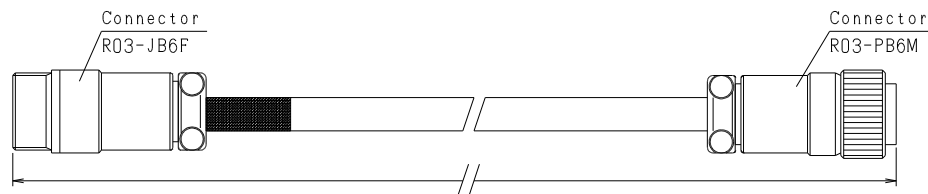

Extension cable(2m~30m)

Connector (Pin;R03-JB6F)

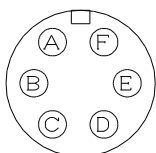

A ; +V      D ; COM  
B ; NC      E ; NC  
C ; -V      F ; SIG

Connector (Soket;R03-PB6M)

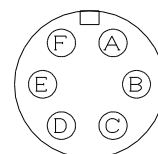

A ; +V      E ; NC  
B ; NC      F ; SIG  
C ; -V  
D ; COM, Shield

## Communication Command Interface

USB : LSI FT245

Transfer Speed : 9600~921600bps  
Data size : 8bit  
Stop bit : 1bit  
Parity check : non

RS-232C :

Transfer Speed : 9600,19200,38400bps  
Data size : 8bit  
Stop bit : 1bit  
Parity check : non

## Format

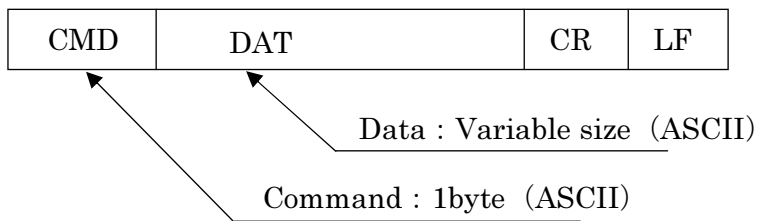

## Command table (CMD)

Capital letters pertain to PC command    Small letters pertain to 4431 command

### Normal Command : Normal Sound Level Meter MODE

No.	Function Item	4431 ↑ PC	PC ↑ 4431	Function Outline
1	Time and date setting request	T		Calendar registration
	Time and date setting completed		t	
2	Configuration file transfer	F		Measurement condition setting
	Configuration file completed		f	
3	Set confirmation	I		Set reading
	Set forwarding		DATA	Set content collection
4	Start measurement	S		Measurement beginning command
	Start measurement		s	
5	Stop measurement	E		Measurement stop command
	Stop measurement		e	
6	Data acquisition completed		r	Data has been secured
7	Data request	D		Data request command
	Data transfer		DATA	Acquisition data collection
8	Calibration	C		Calibration mode command
			c	Only the display
9	Back light	L		LED lighting command
			l	
10	Independent range setting	R		The return is not only in specification.
			r	
11	Filter setting	A		The return is not only in specification.
			a	
12	Lp-value acquisition	P		Data transfer
13	Latm5 Start command	M		Beginning of power value at the maximum noise level in section
			m	
14	LAeq Start command	Q		Beginning of impulse equivalent noise level
			q	
15	Wave data exhaust command	W		Wave data exhaust beginning (USB Only)
			DATA	
16	Version acquisition	V		
			DATA	

### 【Option】

**Filter command:** When Filter card is installed, An additional receipt is done by a usual sound level meter command.

No.	Function Item	4431 ↑ PC	PC ↑ 4431	Function Outline
1	Filter mode	O		Filter mode setting
			o	
2	LB Exhausting special command	B		Filter ber data exhaust beginning (USB Only)
	LB exhaust		DATA	

**【Option】**

FFT Command: When FFT card is installed, An additional receipt is done by a usual sound level meter command.

No.	Function Item	4431 ↑ PC	PC ↑ 4431	Function Outline
1	Frequency span	G		Frequency span setting
			g	
2	Maes Time	H		Measurement time
			h	
3	Window function	J		Window function setting
			j	
4	Mode	K		Addition average or MAX
			k	
5	Filter Lp-value acquisition	N		(USB Only)
			DATA	

## Detail of Command

### Normal Command : Nomal Sound Level Meter MODE

CMD	Function Item	Data Item	Function Outline
T	Time and data setting request	ASCII(13)	YYMMDDHHMMSS
t	Time and data setting completed		Data division note
F	Transfer configuration file	ASCII(5)	<u>A B C D E</u> A :Meas Time select(1) 0 ; * * *   1 ;1s       2 ;3s 3 ;5s       4 ;10s      5 ;1m 6 ;5m       7 ;10m     8 ;15m 9 ;30m      A ;1h       B ;8h C ;12h      D ;24h B :Range setting(1) 0 ;130dB   1 ;120dB 2 ;110dB   3 ;100dB 4 ; 90dB   5 ;80dB C :Filter setting(1) 0 ;A        1 ;C        2 ;F D :Time constant(1) 0 ;FAST    1 ;Slow    2 ;Imp E :Interval(1) 0 ;single  1 ;repeat
f			Data division note
I	Set confirmation command		Data division note
	Set forwarding	ASCII(5)	Conforming of configuration file
S	Start measurement		Data division note
s	Start measurement		
E	Stop measurement		Data division note
e			
r	Data acquisition		Data division note
D	Data request		Data division note
	Data transfer	ASCII(*)	
C	CAL		Data division note
	Operation		CAL ( It stop again by C or E )
L	Data request		Data division note
	Operation		It turns it off by E
R	Range single specification	ASCII(1)	0:130 1:120.....5:80
	Operation		Data division note
A	Filter specification	ASCII(1)	0:A 1:C 2:F
			Data division note
P	Lp-value acquisition		Data division note
	Data transfer	ASCII(5)	
M	Latm5 start		Data division note
m			Data acquisition after "r" command is received
Q	LAleq start		Data division note
q	Measurement start		Data acquisition after "r" command is received

V	Version request		Data division note
	Data transfer		
W	Wave out request		Data division note
	Data transfer		

**【Option】**

**Filter command:** At Filter Card setting, it is usually added to a Sound level meter command

CMD	Function Item	Data Item	Function Lutline
O	Filter setting	ASCII(1)	0: 1/1 1: 1/3
o			Data division note
B	LB exhaust command		Data division note It stops again by E
	Data transfer	ASCII(*)	

**【Option】**

**FFT command:** At Filter Card setting, it is usually added to a Sound level meter command

CMD	Function Item	Data Item	Function Lutline
G	Frequency span	ASCII(1)	0: 20kHz 1: 10kHz 2: 5kHz 3: 2kHz
g			Data division note
H	Mease Time	ASCII(3)	001~999
h			Data division note
J	Window function	ASCII(1)	0: Mann 1: Rect
j			Data division note
K	FFT Mode	ASCII(1)	0: LIN 1: MAX
k			Data division note
N	FFT Lp-value		Data division note
n		ASCII(*)	



## Preparation (To Remote Mode)

1. Main body side setting and screen  
Select Remote Mode manually.

<USB Communicate>		<RS-232C Communicate>	
<System> 1/3		<System> 1/3	
<b>Mode</b>	<b>: Remote U</b>	<b>Mode</b>	<b>: Remote R</b>
Data delet	: off	Data delet	: off
LCD cont	: * * *	LCD cont	: * * *
Date y/m/d	: 01/01/01	Date y/m/d	: 01/01/01
Time h/m/s	: 00:00:00	Time h/m/s	: 00:00:00
Printer(PC)set	: 9600	Remote(PC)set	: 9600
USB out	: OFF	USB out	: OFF

【Normal Screen】

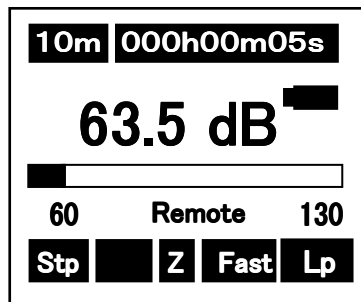

※Display changes int [Remote]  
Inhibiting any other key access than Memu.

Nest time you power on, it starts with [Remote].  
To cancel it, select [Menu] in Menu.

2. Communication timing

