



KANOMAX
The Ultimate Measurements

Remote Particle Sensor

User's Manual

Component List

◆ Standard

| ITEM | MODEL | QTY |
|-------------------------|----------------------|-----|
| Main Unit (3716A/3717A) | 3716A-00 3717A-00 | 1 |
| AC Adapter | — | 1 |
| Filter | 3910-04 | 1 |
| Joint | — | 1 |
| Tygon Tube | — | 1 |
| User's Manual | — | 1 |
| Settings Software (DVD) | 3716A-40 | 1 |

◆ Optional Extras

| ITEM | MODEL | QTY |
|---|----------|-----|
| USB-RS485 Converter (with 3716A-21) | 3716A-20 | 1 |
| Converter Connecting Cable | 3716A-21 | 1 |
| RS232c-RS485 Converter (with 3716A-21) | 3716A-22 | 1 |
| Isokinetic Suction Probe | 3905-07 | 1 |

◆ Consumables

| 品名 | MODEL | QTY |
|---|---------|-----|
| Zero Filter (w/ joint and tube (70cm)) | 3910-04 | 1 |

For more information on optional extras, please contact your distributor or your KANOMAX service center.

Laser Classification

This instrument is classified as a Class 1 Laser Product in accordance with the following standards:

- **EN60825-1: 2007**
- **I EC60825-1: 2007**

CLASS 1 LASER PRODUCT
EN60825-1 : 2007

*Class 1 Laser:

Laser that are considered to be safe under the foreseeable conditions of operation, including the use of optical instruments for intrabeam viewing.

Laser Safety Instruction



Danger – This instrument employs a laser inside the unit as the light source of the sensor. Never open/close the case of the unit or disassemble the optical sensor inside the unit.

| | |
|----------------|-------------|
| Wave Length | 775 – 800nm |
| Maximum Output | 80mW |



Caution – Use of controls, adjustments or performance of procedures other than those specified herein may result in hazardous radiation exposure.

Important Safety Information

In this manual, warning types and classifications are defined as follows:

[Classification]



WARNING: To Prevent Serious Injury or Death

Indicates a potentially hazardous situation which, if not avoided, may result in serious injury or death.



CAUTION: To Prevent Damage to the Product

Indicates a potentially hazardous situation which, if not avoided, may result in damage to the product that may void the product warranty.

[Description of Symbols]





△ Indicates a condition (including danger) that requires caution. The subject of each caution is illustrated inside the triangle (e.g., the symbol shown to the left is the high temperature caution).





⊘ Indicates a prohibition. Do not take the prohibited action shown inside or near this symbol (e.g., The symbol shown to the left prohibits disassembly).



● Indicates a mandatory action. A specific action is described near the symbol.

|  WARNING | |
|---|---|
|  Do not modify/disassemble | <p>◆ Do not disassemble, modify or repair the instrument.</p> <p>..... Misuse of the instrument may result in electric shock, fire, or damage to the instrument, etc.</p> |
|  Handle Properly. | <p>◆ Use this instrument properly by carefully following this operation manual.</p> <p>..... Misuse of the instrument may result in electric shock, fire, or damage to the instrument. etc.</p> |

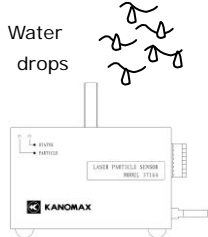
| | |
|--|--|
|  | <ul style="list-style-type: none"> ◆ If any abnormal noises, unusual odors or smoke are observed, or any liquid enters the instrument, turn the power off immediately, remove the battery and disconnect the power cable. <p>..... It may result in electric shock, fire or damage to the instrument. Contact your distributor or your KANOMAX service center for repair.</p> |
|  <p>Prohibition</p> | <ul style="list-style-type: none"> ◆ Do not install the instrument where it will be exposed to rain and/or water drops. <p>..... It may result in electric shock, fire, serious injury or death.</p>  |





| <h2>Caution</h2> | |
|--|---|
|  | <ul style="list-style-type: none"> ◆ Unplug the power cord when the instrument is not in use. <p>.....Failure to observe the above may result in electrical shock, fire or damage to internal circuitry.</p> |
|  <p>Handle Properly</p> | <ul style="list-style-type: none"> ◆ When using a power cord or an AC adapter, make sure to use the one provided with this instrument. <p>.....Other commercially available cords may have different voltage specifications and polarity, which could result in a short circuit, fire or damage to the instrument.</p> |
|  <p>Prohibition</p> | <ul style="list-style-type: none"> ◆ Do not perform measurements in environments exceeding or falling below the specified temperatures and RH levels of the instrument. <p>.....The instrument may not function properly outside the specified environment (10-35 °C, 20~85%RH, with no condensation).</p> |
|  <p>Prohibition</p> | <ul style="list-style-type: none"> ◆ Do not subject the instrument to strong shock. Do not place heavy objects on the instrument or sensor. <p>.....Failure to observe the above may cause damage to the instrument.</p>  |

Table of Contents

| | |
|--|-----------|
| 1. Part Names and Functions | 1 |
| 1.1 General Outline | 1 |
| 1.2 Part Names and Functions | 1 |
| 1.3 USB-RS485 Converter | 2 |
| 1.4 Connection with the Distributor for the CRMS | 4 |
| 2. Getting Started | 5 |
| 2.1 Power Supply | 5 |
| 2.1.1 AC Adapter | 5 |
| 2.1.2 DC Power Supply | 5 |
| 2.2 Parameter Settings | |
| | 6 |
| 2.3 Connecting the Vacuum Source | 7 |
| 2.4 Connecting the Analog Output Terminal | 7 |
| 2.5 Connecting RS485 Connector | 10 |
| 2.6 Connecting the Zero Filter | 10 |
| 3. Measurements | 11 |
| 4. Main Specifications | 12 |
| 5. Troubleshooting | 13 |
| 6. Warranty and After-sales Service | 14 |

1. Part Names and Functions

1.1 General Outline

- ◆ This instrument (Model 3716A/3717A) is a light-scattering laser particle sensor using a laser diode as the light source. The output of the measurement data is from 4-20mA, based on the current system.
- ◆ This instrument is connectable to the "Clean Room Monitoring System (CRMS)", allowing it to perform measurements in a clean room environment for a prolonged time.
- ◆ The status lamp allows this instrument to display LD errors and flow rate errors.
- ◆ When a particle concentration higher than the configured one in the alarm setting, is detected the device will output the alarm signal.

1.2 Part Names and Functions

(Unit: mm)

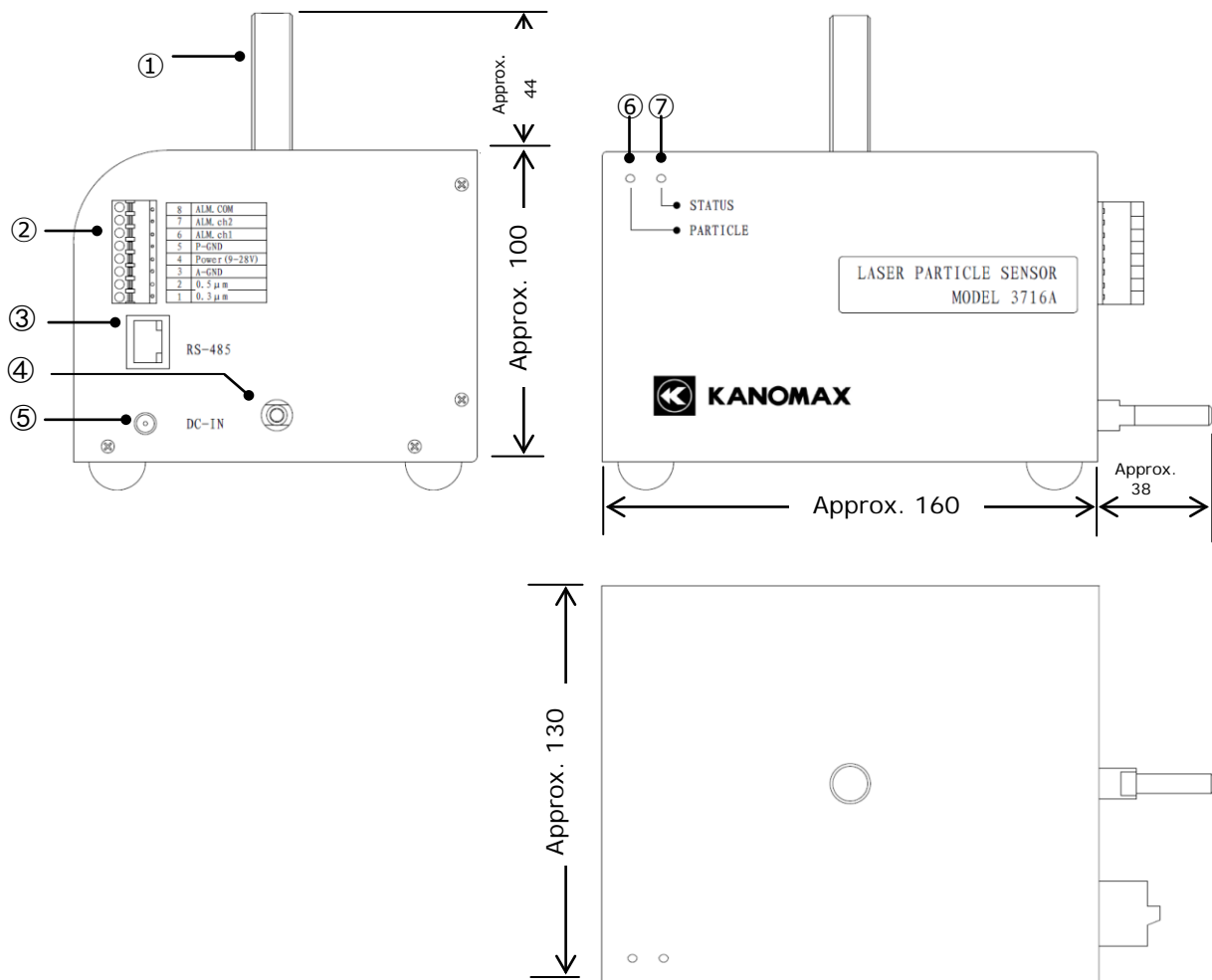

| Number | Name | Function |
|--------|------------------------|--|
| ① | Inlet | This is where sample air is taken in. It can also be used with the provided Tygon tubing. |
| ② | Analog Output Terminal | This consists of a DC power input, an analog output terminal, and an alarm output terminal. For detailed functions, refer to 2.4 Connecting the Analog Output Terminal . |
| ③ | RS485 Connector | This is a connector to communicate with a PC. To connect it, a USB-RS485 Converter (Converter + Converter Connecting Cable) or a distributor (distributor for the CRMS) will be required. The address of the main unit, sampling time, measurement range and alarm settings are can be configured by a PC. For more details, refer to 2.5 Connecting RS485 Connector . |
| ④ | Outlet | Connect a vacuum source to the outlet. For information about the performance of the vacuum source, refer to 2.3 Connecting the Vacuum Source . |
| ⑤ | Power Supply Inlet | This is an inlet to supply DC power to the main unit. Connect the provided AC adapter to this inlet. Refer to 2.1.1 AC Adapter . |
| ⑥ | PARTICLE Lamp | This is the orange lamp. When a particle is detected, the lamp blinks once. When no particles are detected, the lamp is not lit. |
| ⑦ | STATUS Lamp | When the conditions of the flow rate and laser diode are normal, this lamp is green. When a flow error or a laser diode error occurs, this lamp is red. |

1.3 USB-RS485 Converter

- ◆ To set the parameters of this instrument, use the provided setting software (MODEL 3716A-40). To configure the settings, a USB-RS485 converter (including a converter connecting cable) is required. A USB-RS485 Converter, MODEL 3716A-20 (with a Converter Connecting Cable MODEL, 3716A-21) is available as an optional extra. For more details, please contact your distributor or your KANOMAX service center.
- ◆ When preparing a USB-RS485 Converter, please refer to the instruction on the next page. Converter connecting cables (MODEL 3716A-21) are also sold as optional extras.

◆ Connection Method

The following Figures show how to connect the instrument, a USB-RS485 Converter and a PC. For more details, refer to the information accompanied with USB-RS485 Converter MODEL, 3716A-20 (with a Converter Connecting Cable, MODEL 3716A-21).

- USB-RS485 Converter Model : USB-4W485-RJ45-T9P

Manufacturer: System Sacom Industry Corp.

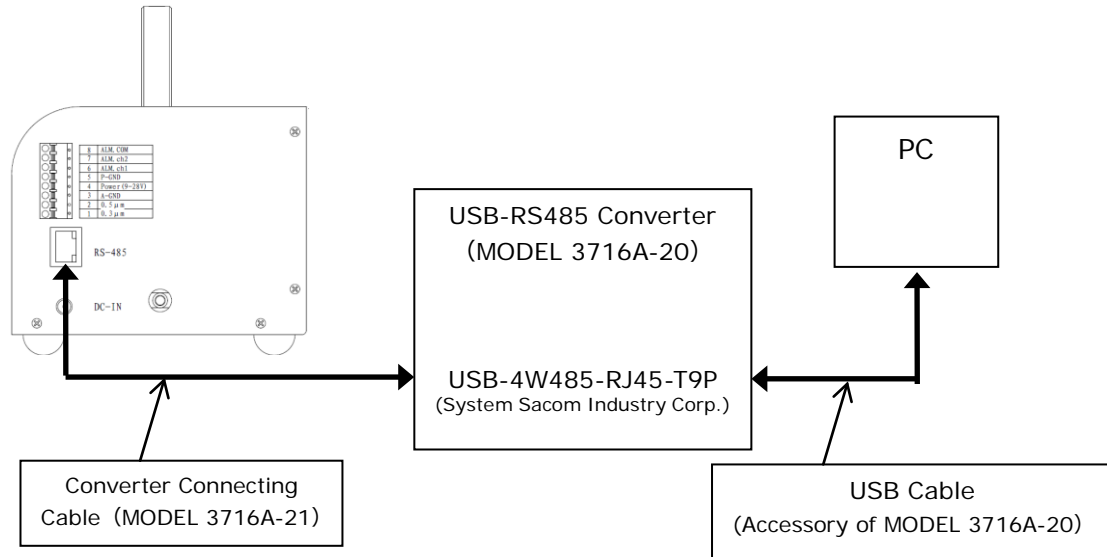

◆ Connection Method of the Converter Connecting Cable and USB-RS485 Converter

Converter Cable 3716A-21

| Number | Signal name (this instrument) |
|--------|-------------------------------|
| 1 | TXD+ |
| 2 | TXD- |
| 3 | RXD+ |
| 4 | RXD- |
| 5 | GND |
| 6 | GND |
| 7 | +24V input |
| 8 | +24V input |
| Case | Shield |

USB-4W485-RJ45-T9P

| Number | RS485 Converter |
|--------|-----------------|
| 4 | RXD+ |
| 5 | RXD- |
| 1 | TXD+ |
| 2 | TXD- |
| 3 | GND |
| 6 | GND |
| 7 | NC |
| 8 | NC |
| 9 | NC |

Note: To supply power through the converter connecting cable, supply 9-28V to +24V and GND. When power is supplied through the provided AC adapter and analog output terminal, do not connect to the converter. In this case, the terminal not in use should be insulated.

1.4 Connection with the Distributor for the CRMS

- ◆ Connecting this instrument with the distributor for the CRMS allows for operation with the Clean Room Monitoring System. For more information on the distributor for the CRMS, please contact your distributor or your KANOMAX service center.
- ◆ Connection Method
The following Figure shows how to connect this instrument with the distributor for the CRMS:

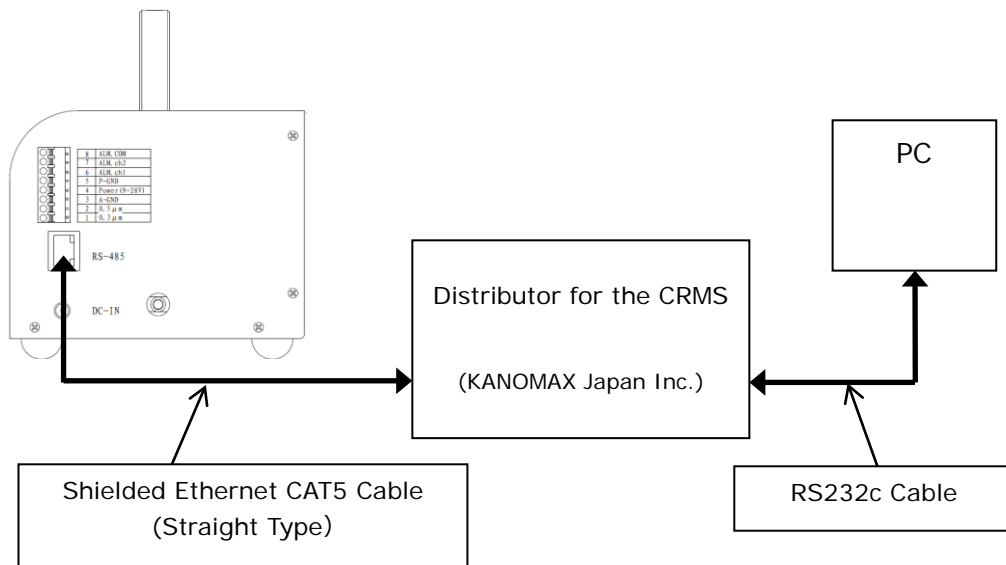

2. Getting Started

2.1 Power Supply

2.1.1 AC Adapter

- ◆ Plug the AC adaptor in the inlet. The specification of the provided AC adapter is as follows (When purchasing AC adapter for yourself, refer to [4. Main Specifications](#)):

Input/Output Specification : Input AC 100-240V (50-60Hz) ,
Output DC 12V 0.5A

Plug Specification :

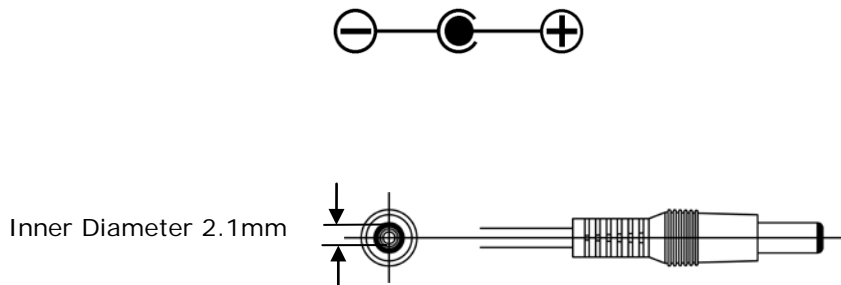

2.1.2 DC Power Supply

- ◆ By using No.4 Pin Power (9-28V) and No.5 Pin P-GND of the analog terminal, DC power can be supplied. (Note: Pay careful attention to the connecting order.)

| | |
|---|---------------|
| 8 | ALM. COM |
| 7 | ALM. ch2 |
| 6 | ALM. ch1 |
| 5 | P-GND |
| 4 | Power (9-28V) |
| 3 | A-GND |
| 2 | 0.5 μm |
| 1 | 0.3 μm |

3716A Analog Terminal

| | |
|---|---------------|
| 8 | ALM. COM |
| 7 | ALM. ch2 |
| 6 | ALM. ch1 |
| 5 | P-GND |
| 4 | Power (9-28V) |
| 3 | A-GND |
| 2 | 5.0 μm |
| 1 | 0.5 μm |

3717A Analog Terminal

- ◆ Power also can be supplied through the RS485 connecting terminal. Connecting the CRMS distributor and RS485 to supply power to the instrument. For more details on the distributor for the CRMS, please contact your distributor or your KANOMAX service center.

2.2 Parameter Settings

- ◆ Before starting a measurement, the parameter settings must be configured. Prior to the parameter settings, please read the software operation manual.
- ◆ Before setting the parameters, connect the 3716A/3717A, a power supply for 3716A/3717A, the USB-RS485 Converter (converter, connecting cable) and a PC (that has the software installed) .
- ◆ Sampling time settings: The settable range is 1-60 seconds, at a rate of 1.0 second. All data compiled within the configured sampling time will be transmitted via the analog output (4-20mA). This sampling time is shared between 2 channels.
* The factory setting is 1 second.
- ◆ Output range settings: Configures the range of the particle count and concentration. The analog output will be 4 to 20mA within the configured range. The following figure shows this setting range, which is shared between 2 channels.
* The factory setting is 01 (0-10CNT).

| Setting Code | Output Range | Count / Concentration |
|--------------|---------------------------------|-----------------------|
| 01 | 0-10CNT | Count |
| 02 | 0-100CNT | |
| 03 | 0-1,000CNT | |
| 04 | 0-10,000CNT | |
| 11 | 0-10CNT/cf | Concentration |
| 12 | 0-100CNT/cf | |
| 13 | 0-1,000CNT/cf | |
| 14 | 0-1,000,000CNT/cf | |
| 21 | 0-353CNT/m ³ | |
| 22 | 0-3,530CNT/m ³ | |
| 23 | 0-35,300CNT/m ³ | |
| 24 | 0-353,000,000CNT/m ³ | |

- ◆ Alarm Settings: Sets the measurement range (0-100%) in 1% increments. An alarm setting can be configured per 2 channels. If the detected particle counts exceeds the configured alarm level of concentration, the alarm signal will be sent. For more details on the alarm settings, refer to [2.4 Connecting the Analog Output Terminal](#).
*The factory setting is 0 (for both CH1 and CH2).
- ◆ Address Settings: Sets the address of this instrument. The settable range is 0-512. The addresses are used to identify each instrument when using multiple instruments.
*The factory setting is 0.
- ◆ Sensor Communication Settings: Configures the communication setting of the instrument.
Configures the communication settings between this

instrument and upper-layer PC/CRMS distributor.

Baud rate: Select from 4800, 9600, 19200, and 38400bps.

Data bit : Select 7 bits or 8 bits.

Parity : Select between Even, Odd or None.

*The communication settings with the distributor for the CRMS is fixed: 9600bps, 7 bits and Even. The factory setting is the same as the above.

2.3 Connecting the Vacuum Source

- ◆ 3716A/3717A measurement requires a connection with an external vacuum source. The performance of the vacuum source should meet with the required specifications. For more details, refer to [4. Main Specifications](#).
- ◆ To confirm the condition of the vacuum source, check the STATUS lamp on the main unit or the output current from No. 1/No. 2 of the analog output terminal. If the output current from the No.1 or No.2 terminal is out of the range of 1-1.8mA or 3-3.8mA, the vacuum source is normal. On the contrary, if output current from No.1 or No.2 terminal is in the range of 1-1.8mA or 3-3.8mA, the vacuum source is bad.

2.4 Connecting the Analog Output Terminal

- ◆ The connector of the analog output terminal of this instrument has an automatic lock function. When inserting and removing the lead, push the lock button (the orange-colored part) on the connector to unlock it. To lock it simply turn the lock button off. To connect the analog output terminal, remove the coating on the tip of the lead and insert it.
- ◆ The connector of the analog terminal is removable. However, we advise keeping it on in order to avoid losing it.

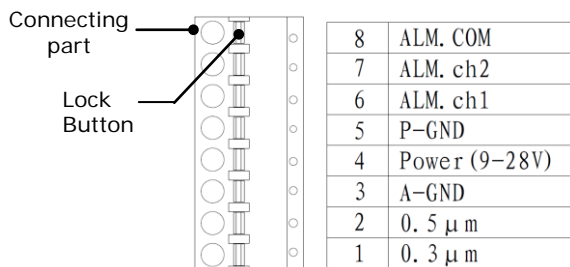

Details of 3716A analog output terminal

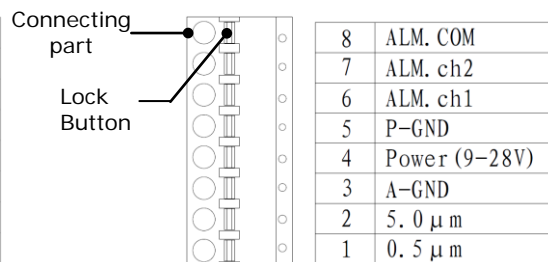

Details of 3717A analog output terminal

◆ The following Figures show the details of the Analog Output terminal.

| Terminal Number | Signal Name (3716A) | Functions |
|-----------------|---------------------|---|
| 1 | 0.3μm | <p>① Current output terminal of particle count or concentration for 0.3μm channel measurement. The output range is 4-20mA.</p> <p>② This output terminal is also used when flow rate errors or LD errors are detected. Current output range of flow rate error is 1-1.8mA. Current output range of LD error is 2-2.8mA. Current output range when both flow rate and LD errors occur at the same time is 3-3.8mA.</p> |
| 2 | 0.5μm | <p>① Current output terminal of particle count or concentration for 0.5μm channel measurement. The output range is 4-20mA.</p> <p>② This output terminal is also used when the flow rate errors or LD errors are detected. Current output range of flow rate error is 1-1.8mA. Current output range of LD error is 2-2.8mA. Current output range when both flow rate and LD errors occur at the same time is 3-3.8mA.</p> |
| 3 | A-GND | Common terminal (-) of current output |
| 4 | Power (9-28V) | Connecting terminal of DC power supply (+) |
| 5 | P-GND | Connecting terminal of DC power supply (GND) |
| 6 | ALM.ch1 | Output terminal of the particle count for 0.3μm channel measurement or concentration for alarm detection. The specification of the connection point of this terminal is 60V 0.4A or less. Use it within this specification. |
| 7 | ALM.ch2 | Output terminal of the particle count for 0.5μm channel measurement or concentration for alarm detection. The specification of the connection point of this terminal is 60V 0.4A or less. Use it within this specification. |
| 8 | ALM.COM | Common terminal (-) of the alarm output terminal |

| Terminal Number | Signal Name (3717A) | Functions |
|-----------------|---------------------|---|
| 1 | 0.5μm | <p>① Current output terminal of particle count or concentration for 0.5μm channel measurement. The output range is 4-20mA.</p> <p>② This output terminal is also used when the flow rate errors or LD errors are detected. Current output range of flow rate error is 1-1.8mA. Current output range of LD error is 2-2.8mA. Current output range when both flow rate and LD errors occur at the same time is 3-3.8mA.</p> |
| 2 | 5.0μm | <p>① Current Output terminal of particle count or concentration for 5.0μm channel measurement. The output range is 4-20mA.</p> <p>② This output terminal is also used when the flow rate errors or LD errors are detected. Current output range of flow rate error is 1-1.8mA. Current output range of LD error is 2-2.8mA. Current output range when both flow rate and LD errors occur at the same time is 3-3.8mA.</p> |
| 3 | A-GND | Common terminal (-) of the current output |
| 4 | Power (9-28V) | Connecting terminal of DC power supply (+) |
| 5 | P-GND | Connecting terminal of DC power supply (GND) |
| 6 | ALM.CH1 | Output terminal of particle count for 0.5μm channel measurement or concentration for alarm detection. The specification of the connection point of this terminal is 60V 0.4A or less. Use it within this specification. |
| 7 | ALM.CH2 | Output terminal of particle count for 5.0μm channel measurement or concentration for alarm detection. The specification of the connection point of this terminal is 60V 0.4A or less. Use it within this specification. |
| 8 | ALM.COM | Common terminal (-) of the alarm output terminal |

2.5 Connecting RS485 Connector

- ◆ When setting the parameters of 3716A/3717A, connect an RS485 connector and PC with the optional extra, USB-RS485 converter (converter + connecting cable). Activate the provided settings software to set the parameters of this instrument.

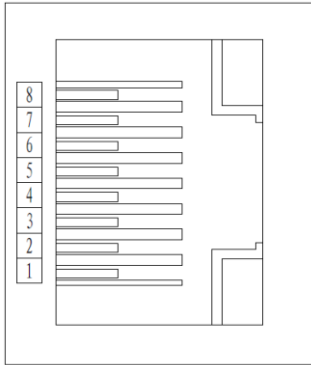

RS485 Connector

| Pin Number | RS485 Connector Signal Name |
|------------|---|
| 1 | RS485 TXD + |
| 2 | RS485 TXD - |
| 3 | RS485 RXD + |
| 4 | RS485 RXD - |
| 5, 6 | DC power supply (-) terminal (P-GND) |
| 7, 8 | DC power supply (+) terminal (DC 9-28V) *Not in use when the power is supplied through the AC adapter or the analog output terminal. |

- ◆ Both 3716A and 3717A are connectable to the Clean Room Monitoring System (CRMS) using an RS485 connector.

2.6 Connecting the Zero Filter

- ◆ To confirm the cleanness of the optical system, conduct a zero check before each measurement.
- ◆ Connect the tube side of the zero filter to the inlet of this instrument.
- ◆ The filters must be handled with care.
If air leakage occurs between the two filters and/or between the filter and this instrument, zero checks cannot be conducted properly.

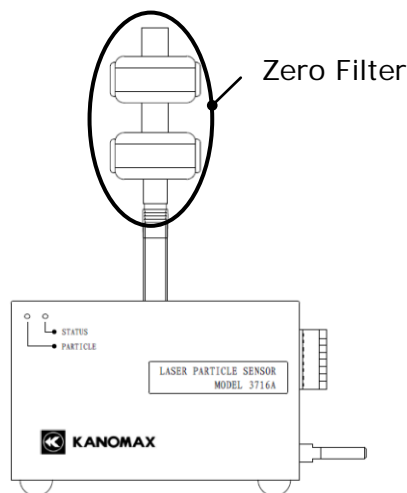

3. Measurement

- ◆ Make sure that all procedures stated in 2.Getting Started in this manual have been completed.
- ◆ To perform measurements, take in sample air directly from the inlet of the 3716A/3717A or take in sample air with the provided Tygon tube connected to the inlet.
- ◆ Turn the power on 3716A/3717 to start a measurement using the configured parameters.
- ◆ If you have a problem with your instrument, such as the condition of the STATUS lamp, the output current value of the analogue output terminal and alarm output status, please refer to 5.Troubleshooting in this manual first to find possible cause(s) and solution(s). If that does not solve the problem, please contact your distributor or your KANOMAX service center for repair.

4. Main Specifications

| | | |
|------------------------------|--|--------------------------|
| Product Name | Laser Particle Sensor | |
| Model | 3716A | 3717A |
| Particle Size Distribution | 0.3 μ m, 0.5 μ m | 0.5 μ m, 5.0 μ m |
| Rated Flow | 28.3L/min (1CFM) | |
| Optical Source | Laser Diode | |
| Counting Efficiency | Compliant with ISO21501-4, JIS B 9921 | |
| Max Detectable Concentration | 500,000CNT/ft ³ | |
| Setting Parameter | Sampling Time : 1 to 60 seconds | |
| | Output Range Setting Count : 0-10CNT, 0-100CNT, 0-1000CNT, 0-10000CNT Concentration : 0-10CNT/cf, 0-100CNT/cf, 0-1,000CNT/cf, 0-1,000,000CNT/cf 0-353CNT/ m ³ , 0-3,530CNT/m ³ , 0-35,300CNT/m ³ , 0-353,000,000CNT/m ³ | |
| | Alarm Setting : 0% – 100% | |
| | Address Setting : 0—512 | |
| Sampling Pump | External Pump | |
| Interface | RS485, Analog Output (4-20mA) | |
| Communication | RS485 | |
| Parameter Setting Software | Japanese, English | |
| Power Supply | ①DC Power Supply DC 9V – 28V ②AC Adapter AC 100-240V (50-60Hz) , DC 12V | |
| Operating Environment | 10~30°C 20~85%RH (Non Condensing) | |
| Storing Environment | Temperature: -10 to 50°C Humidity: 95%RH or less (Non Condensing) | |
| Dimension | 160 (W) × 130 (D) × 100 (H) mm | |
| Weight | 1.6Kg | |
| Standard Accessories | Operation manual (1), AC adapter (1), Zero filter (1), Joint (1), Tygon tube (1), Setting software DVD (1) | |
| Optional Extras | USB-RS485 Converter 3716A-20 (Converter + Converter Connecting Cable)、Converter Connecting Cable 3716A-21、RS232c-RS485 Converter 3716A-22 (Converter + Converter Connecting Cable)、Isokinetic Suction Probe 3905-07 | |

5. Troubleshooting

| Problems | Possible Cause(s) / Solution(s) | Page |
|---|---|------|
| No power. | Defective adapter → Replace the adapter. | 5 |
| | The lead of the DC power supply is not connected correctly. → Connect to the lead correctly. | 5 |
| | Poor connection to the CRMS → Reconnect to the CRMS. | 10 |
| STATUS lamp is not lit. | No connection to the power supply → Connect to the power supply. | 5 |
| | The lamp is damaged. → Return the instrument for repair. | 14 |
| STATUS lamp lights up in red. | The vacuum source is not operating or not capable of operating. → Operate the vacuum source. Replace the vacuum source with a better one. | 7 |
| | The vacuum source has piping leakage or a clogged pipe. → Inspect the vacuum source for leaks or clogs. Clear any clogs of the pipe. | --- |
| | The internal piping is clogged. → Return the instrument for repair. | 14 |
| | An internal part is damaged. → Return the instrument for repair. | 14 |
| PARTICLE lamp is not lit when detecting particles | Internal part failure → Return the instrument for repair. | 14 |
| Analog output (4~20mA) has an output error. | Wiring error of the analog output → Rewire the analog output correctly. | 7 |
| | Internal circuit failure → Return the instrument or repair. | 14 |
| Output error of the alarm terminal | Wiring error of the analog output → Rewire correctly. | 7 |
| | Internal circuit failure → Return the instrument for repair. | 14 |
| Clean Room Monitoring System (CRMS) suffers from a communication/ measurement data error. | Wiring error → Confirm the wiring of RS485 cable. | 10 |
| | Internal circuit failure → Return the instrument for repair. | 14 |
| | PC software setting error → Contact your distributor or your KANOMAX service center for repair. | 14 |

6. Warranty and After-sales Service

KANOMAX Limited Warranty

The limited warranty set below is given by KANOMAX with respect to the KANOMAX brand Airborne Particle Counter, its attachment parts including Probe and other accessories (hereafter referred to as "PRODUCT") that you have purchased. PRODUCT you have purchased shall be the only one that the limited warranty stated herein applies to.

Your PRODUCT, when delivered to you in new condition in its original container, is warranted against defects in materials or workmanship as follows: for a period of three (3) years from the date of original purchase, defective parts or a defective PRODUCT returned to your sales representative, as applicable, and proven to be defective upon inspection, will be exchanged for a new or comparable rebuilt parts, or a refurbished PRODUCT as determined by your sales representative. Warranty for such replacements shall not extend the original warranty period of the defective PRODUCT.

This limited warranty covers all defects encountered in normal use of the PRODUCT, and does not apply to the following cases:

- (1) Use of parts or supplies other than the PRODUCT sold by your sales representative, which cause damage to the PRODUCT or cause abnormally frequent service calls or service problems.
- (2) If any PRODUCT has its serial number or date altered or removed.
- (3) Loss of damage to the PRODUCT due to abuse, mishandling, improper packaging by the owner, alteration, accident, electrical current fluctuations, failure to follow operating, maintenance or environmental instructions prescribed in the PRODUCT's instruction manual provided by KANOMAX, or service performed by a party other than KANOMAX.

NO IMPLIED WARRANTY, INCLUDING ANY IMPLIED WARRANTY OF MERCHANTABILITY OR FITNESS FOR A PARTICULAR PURPOSE, APPLIES TO THE PRODUCT AFTER THE APPLICABLE PERIOD OF THE EXPRESS LIMITED WARRANTY STATED ABOVE, AND NO OTHER EXPRESS WARRANTY OR GUARANTY, EXCEPT AS MENTIONED ABOVE, GIVEN BY ANY PERSON OR ENTITY WITH RESPECT TO THE PRODUCT SHALL BIND KANOMAX. KANOMAX SHALL NOT BE LIABLE FOR LOSS OF STORAGE CHARGES, LOSS OR CORRUPTION OF DATA, OR ANY OTHER SPECIAL, INCIDENTAL OR CONSEQUENTIAL DAMAGES CAUSED BY THE USE OR MISUSE OF, OR INABILITY TO USE, THE PRODUCT, REGARDLESS OF THE LEGAL THEORY ON WHICH THE CLAIM IS BASED, AND EVEN IF KANOMAX HAS BEEN ADVISED OF THE POSSIBILITY OF SUCH DAMAGES. IN NO EVENT SHALL RECOVERY OF ANY KIND AGAINST KANOMAX BE GREATER IN AMOUNT THAN THE PURCHASE PRICE OF THE PRODUCT SOLD BY KANOMAX AND CAUSING THE ALLEGED DAMAGE. WITHOUT LIMITING THE FOREGOING, THE OWNER ASSUMES ALL RISK AND LIABILITY FOR LOSS, DAMAGE OF, OR INJURY TO THE OWNER AND THE OWNER'S PROPERTY AND TO OTHERS AND THEIR PROPERTY ARISING OUT OF USE OR MISUSE OF, OR INABILITY TO USE, THE PRODUCT NOT CAUSED DIRECTLY BY THE NEGLIGENCE OF KANOMAX. THIS LIMITED WARRANTY SHALL NOT EXTEND TO ANYONE OTHER THAN THE ORIGINAL PURCHASER OF THE PRODUCT, OR THE PERSON FOR WHOM IT WAS PURCHASED AS A GIFT, AND STATES THE PURCHASER'S EXCLUSIVE REMEDY.

After-sales Service

If the PRODUCT is malfunctioning, please see "Troubleshooting" page 13 to find possible causes first.

Repair parts are retained for a minimum period of five (5) years after production cessation of the PRODUCT. This storage period of repair parts is considered as the period during which KANOMAX can provide repair service.

For more information, please contact your sales representative. When you call, please have the following information at hand:

- (1) PRODUCT name;
- (2) Model number;
- (3) Serial number;
- (4) Probe number;
- (5) Description of Symptom, and;
- (6) Date of purchase



KANOMAX

USA & Europe

KANOMAX USA, INC.

PO Box 372, 219 US Hwy. 206, Andover, NJ 07821 U.S.A.

TEL: 1-800-247-8887 / 1-973-786-6386 **FAX:** 1-973-786-7586

URL: <http://www.kanomax-usa.com/>

E-Mail: info@kanomax-usa.com

Japan & Asia

KANOMAX JAPAN INC.

2-1 Shimizu Suita City, Osaka 565-0805, Japan

TEL: 81-6-6877-0183 **FAX:** 81-6-6877-5570

URL: <http://www.kanomax.co.jp/>

E-Mail: sales@kanomax.co.jp

China

Shenyang Kano Scientific Instrument Co., Ltd

No. 12, 4 Jia Wencui Road Heping District

Shenyang City, PRC

TEL: 86-24-23845309 **FAX:** 86-24-23898417

URL: <http://www.kanomax.com.cn/>

E-Mail: sales@kanomax.com.cn

Copyright © Kanomax Japan Inc. All rights reserved.

2013

No copying, distribution, publication, modification, or incorporation of this document, in whole or part, is permitted for commercial purposes without the express written permission of Kanomax.

The contents of this document may be changed without prior notice.

01001/13.06