



Handheld Laser Particle Counter

MODEL 3887

Operation Manual



Read this manual carefully and understand the warnings described in this manual before operating the product.

Keep this manual handy for future reference.



06001

07. 12

Thank you for purchasing a product of Kanomax, Inc.
Please read this operation manual carefully and operate the
instrument appropriately by following the instructions given
in this manual.

Important Safety Information

Types and definitions of warning signs used in this operation manual are shown below.



Danger: To prevent serious injury or death

Warnings in this classification indicate danger that may result in serious injury or death if not observed.



Caution: To prevent damage to the product.

Warnings in this classification indicate risks of damage to the product and performance failure that affect the product warranty if not observed.

[Description of Symbols]



△ This symbol indicates a condition (including danger) that requires caution. The subject of each caution is illustrated inside the triangle (e.g., high temperature caution symbol shown on the left).



⊘ This symbol indicates prohibition. Do not take a prohibited action shown inside or near this symbol (e.g., disassemble prohibiting symbol shown on the left).



● This symbol indicates a mandatory action. A specific action is given near the symbol.



⚠ This symbol indicates a warning of possible laser radiation.

 **Danger**

○ **Never disassemble or heat the battery pack, or discard the battery pack in fire.**

- The battery pack may explode.



Explosive



Handle Properly



○ **For AC power supply, do not use the AC adapter other than the one supplied with the instrument.**

- An inappropriate adapter may damage the instrument.
- It may generate heat and cause fire.



Prohibition

○ **Never disassemble, modify or repair.**

- This instrument uses a Class 3B laser diode as the light source. Exposure to the laser may cause loss of eyesight and other injury.
- Disassembly may cause short circuit and/or other failure.



Do Not Modify or Disassemble



○ **Handle the instrument properly in accordance with the instructions provided in this operation manual.**

- Improper use may cause electric shock, fire hazard, and damage.



Handle Properly

○ **If abnormal noise, smell or smoke is observed, or if liquid has entered the instrument, turn off the power immediately, remove the batteries or pull out the plug.**

- Failure to observe the above may cause electric shock, fire hazard or damage.

Please contact your local distributor or Kanomax's service center for repair.



 **Caution**

○ **Do not use or keep the instrument in hot, humid, or dusty environment.**

- The instrument may not function properly outside the specified temperature range.
- Exposure to direct sunlight may discolor or deform the instrument.



Prohibited Installation

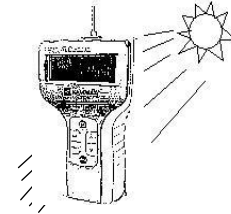

○ **Do not drop or hit the instrument.**

- Dropping or hitting the instrument may cause damage and malfunctioning.



Prohibition

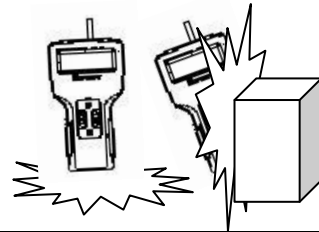

○ **Set batteries in the correct direction.**

- Setting the batteries in the wrong direction may cause leakage, leading to contamination of the instrument and surroundings.



Insert Properly

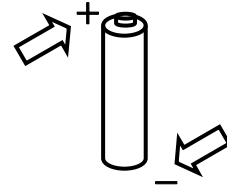

○ **Do not wipe the instrument with a volatile solvent.**

- The body may deform or deteriorate. Use soft dry cloth to remove stains. If stains persist, soak the cloth in a neutral detergent and wipe the instrument with a soft cloth.
- Do not use volatile solvents such as thinner and benzene.



Prohibition

○ **Do not use the instrument near equipment emitting high radiation noise.**

- The instrument may malfunction due to the noise.



Handle Properly

○ **Connect the AC adapter to a power source with minimum noise.**

- The noise may cause malfunctioning.



Caution

○ **Pull out the plug when the instrument is not in use.**

- Failure to observe the above may cause electrical shock, fire hazard, and circuit damage.



○ **If the instrument is not to be used for a long period, the batteries must be removed from the battery compartment. Do not leave spent batteries in the battery compartment.**

- Failure to observe the above may cause battery leakage.



Handle Properly

Table of Contents

1. Packing List.....	1
1.1 Standard Accessories.....	1
1.2 Optional Accessories (Sold Separately).....	1
2. Description of Components.....	2
3. Precautions for Use	4
4. Measurement Modes	5
4-1 REPEAT Mode.....	6
4-2 SINGLE Mode.....	10
4-3 CONT Mode	12
4-4 CALC Mode	14
4-5 REMOTE Mode.....	16
4-6 ISO>4 Mode	18
5. View Stored Data.....	21
5-1 Viewing Stored Data on LPC Screen.....	22
5-2 Printing Stored Data.....	23
5-3 Delete Stored Data	26
6. Useful Functions	27
6-1 Alarm	28
6-2 Changing Measurement Unit	29
6-3 Calendar Setting.....	30
6-4 Communication Setting	31
6-5 Hotkey.....	32
6-6 Automatic Measurement Start.....	33
7. Error Messages	34
8. Low Battery Alarm.....	35
9. Specifications	36
10. Troubleshooting.....	37
11. Warranty and After Service	38
12. Contact Information	39

1. Packing List

Check all components when opening the package.

For purchasing optional accessories, please contact your local distributor.

1.1 Standard Accessories

Item	Model	Description
Filter, Tube	3887-03* ¹⁾	To clean the air flow path inside the instrument with clean air.
AC Adaptor, Power Cable	3887-01* ²⁾	To operate the instrument with AC power, especially for continuous measurement.
Ni-MH Batteries	HR-3U (or product of same specification)	To operate the instrument with battery power. *The batteries cannot be charged by using the AC adapter. The dedicated charger listed below must be used for charging the batteries.
Rapid Charger	NC-NQR02 (or product of same specification)	To recharge the Ni-MH batteries. Charging time is approx. 240min.
Application Software CD	S388-70	For operations such as transferring the data stored in the instrument memory to a computer, or controlling the instrument by a computer. *Operation Manual for Application Software is saved in the CD.
RS232C Cable	3887-08	To connect the instrument with a computer.
Stand		To stabilize the instrument for measurement.
Isokinetic Probe		To be connected to the inlet to match the measurement condition with the sampling air.
Traceability Certificate		Calibration certificate.

1.2 Optional Accessories (Sold Separately)

Item	Model	Description
Printer	DPU-H245	To directly print the measured data from the instrument.
Printer Cable	3887-07	To connect the instrument with a printer.
Carrying Case	3887-02	To store the instrument.
Tripod		To stabilize the instrument for measurement.

*1) Model 3887-03 includes a filter and a connection tube.

*2) Model 3887-01 does not include an extension power cable.

2. Description of Components

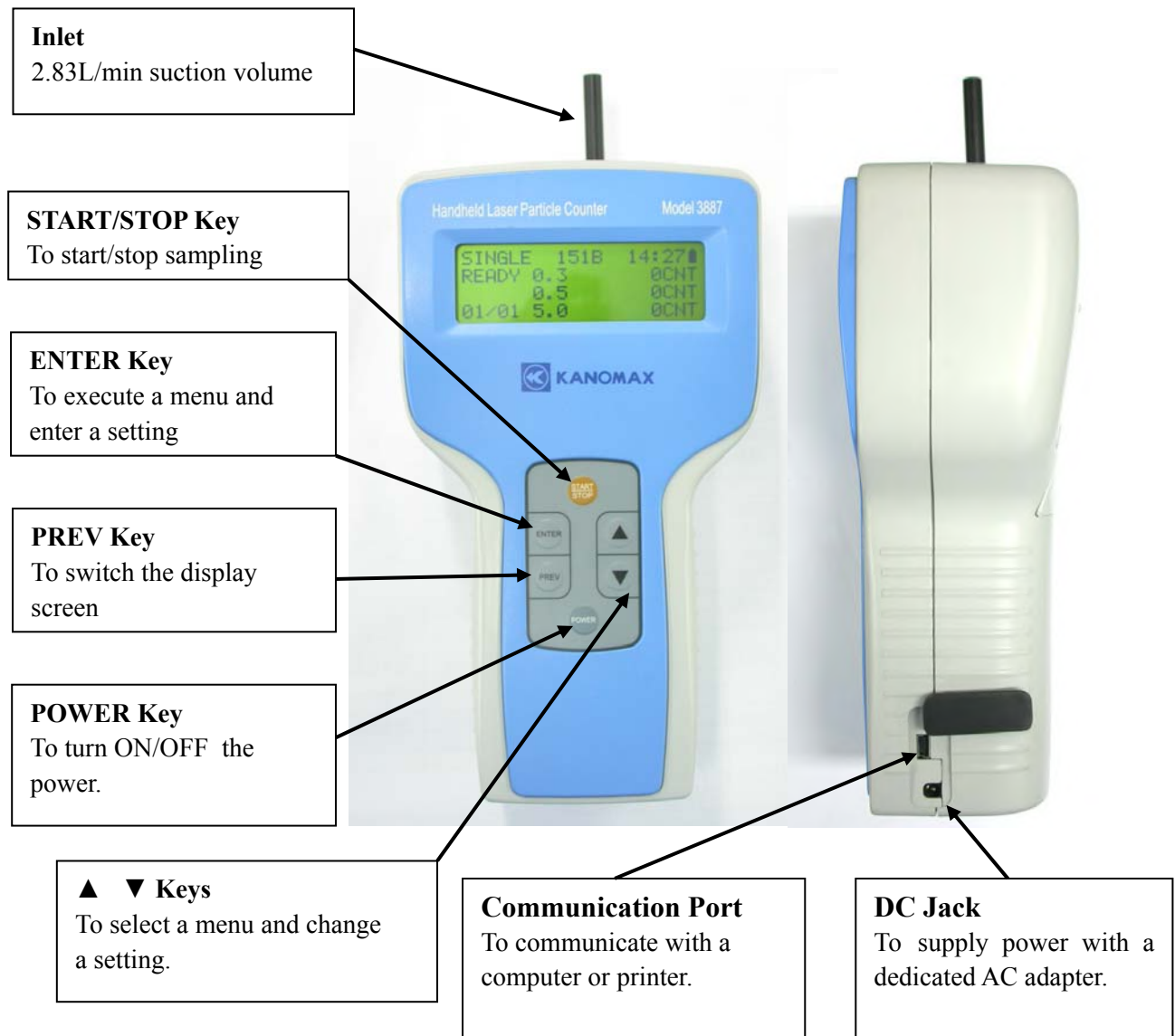



Battery Compartment

Use four (4) AA rechargeable batteries or alkaline batteries. Operating hours by battery power are only ensured when using the supplied Ni-MH batteries.

3. Precautions for Use

The following precautions must be taken when using the instrument.

- **Sampling**

There are possibilities of particle deposit/rescattering when sampling is performed by using a tube connected to the inlet. It is recommended that sampling is performed without using the tube. However, if a tube is required for sampling, the tube recommend below must be used.

- **Sampling Tube**

Recommended Sampling Tube:

TYGON Inner Diameter 4.3mm × Outer Diameter 7.5mm: Product or Norton

This product can be purchased from dealers of physical and chemical equipment, as well as through our sales offices.

- **Power**

The instrument can be powered by AA batteries or AC power.

- **AC Power**

For AC-powered operation, the dedicated AC adapter supplied with the instrument must be used. The AC adapter accommodates voltage of AC 86-264V 50/60Hz, however, the connection plug is dedicated to AC 100V.

- **AA Batteries**

In addition to the supplied AA rechargeable batteries (Ni-MH 1.2V 1600mA), alkali batteries can be used as well.

Maximum continuous operating hours:

- When using alkali batteries : 1 hour
- When using the supplied rechargeable batteries : 3 hours

The above continuous operating hours are subject to change due to operational conditions such as ambient condition, or use of the sampling tube.

- **Caution for Extremely Long Measurement Periods**

The instrument is unsuitable for continuous measurements for a prolonged period. It may hasten deterioration of the light source and inner pump, and require maintenance in a shorter interval.

- **For Prolonged Measurements**

Note that the data will not be saved if the power is cut during a measurement.

Make sure to prevent running out of batteries or power cut of AC power.

- **Sampling Environment**

The instrument is designed for use in clean rooms or clean environments where the concentration is below the maximum measurable concentration of 2,000,000 particles/cf. Using the instrument in a high temperature/humidity environment or in an environment with high particle concentration may cause damage to the instrument or shorten the maintenance interval.

4. Measurement Modes

The instrument is equipped with six (6) measurement modes.

● **REPEAT Mode** (Suitable for repeated measurement at a same location.)

Measurement of a certain sampling period and interval can be repeated from twice to infinite number of times. When storing the measurement data, the maximum number of measurements is 10,000 times.

● **SINGLE Mode** (Single measurement which stops when set sampling time has elapsed.)

Measurement stops automatically when set sampling time has elapsed.

● **CONT (Continuous) Mode** (Suitable for measurement of random time)

Measurement is stopped manually.

● **CALC (Calculation) Mode** (Processes results of repeated measurements.)

Measurement is repeated as same as the REPEAT Mode, and based on the results obtained from the repeated measurements, **average, maximum, minimum, and standard deviation** are calculated and displayed.

When storing the data in the instrument in CALC mode, only the calculation result; average, maximum, minimum, and standard deviation will be stored, and detail data from the repeated measurements will NOT be stored.

<Caution>

Storing the data in CALC mode requires memory 4 times larger than that of modes such as REPEAT, SINGLE and CONT Modes. When all data is taken in CALC Mode, maximum 2,500 data records can be stored.

● **ISO>4 Mode** (Suitable for cleanliness assessment of ISO Class 5 to 9)

This mode is suitable for cleanliness assessment in accordance with ISO14644-1, 2 or JIS B9920. The result is displayed by calculating the **average, standard deviation and 95% UCL** automatically from the sampled data and number of sampling times.

● **REMOTE Mode** (Externally controlled measurement)

Measurement is controlled externally by using the software supplied with the instrument.

4-1 REPEAT Mode

Setup procedure is shown below.

(Character positions may not correspond to the actual screen.)

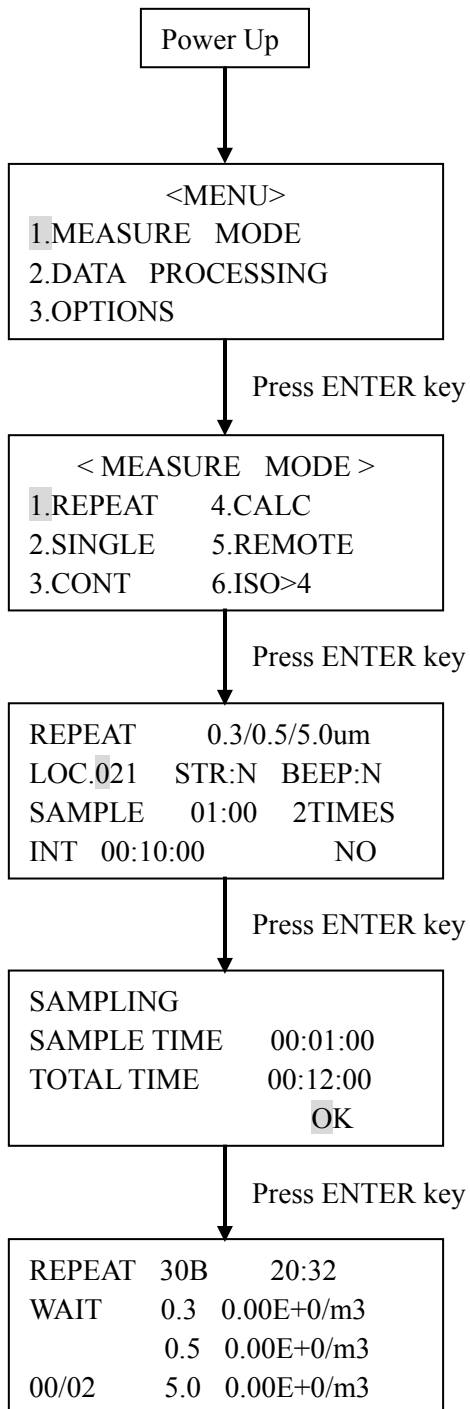

Measurement Setting Screen

LOC.:

LOC number can be used for identifying room numbers or measurements. Setting of this item is not mandatory.

STR:

Used when storing data in the instrument. When storing the data, select “Y” by using the ▲▼ key. Select “N” if you do not want to store the data.

BEEP:

Alarm goes off when alarm level is exceeded.

SAMPLE:

Sets sampling time. Setting range is from 10 sec to 99min 59sec.

TIMES:

Sets number of sampling times. Setting range is from 1 to 99, or CONT (Repeats until storage capacity is reached. Max. 10,000 times.)

INT:

Sets duration of one measurement cycle. Setting range is from 10sec to 99min 59sec. Minimum time is dependent on set sampling time.

Setting of every item is not mandatory.

For example, you can change only the LOC number and press the START/STOP key, and the display will switch to a measurement standby screen.

↓

REPEAT	30B	20:32
READY	0.3	0.00E+0/m3
	0.5	0.00E+0/m3
00/02	5.0	0.00E+0/m3

Press START/STOP key

REPEAT	30B	20:32
RUN	0.3	0.00E+0/m3
00:59	0.5	0.00E+0/m3
01/02	5.0	0.00E+0/m3

WAIT...	30B	20:32
	0.3	0.00E+0/m3
20:42	0.5	0.00E+0/m3
01/02	5.0	0.00E+0/m3

REPEAT	30B	20:32
RUN	0.3	0.00E+0/m3
00:59	0.5	0.00E+0/m3
02/02	5.0	0.00E+0/m3

REPEAT	30B	20:32
END	0.3	0.00E+0/m3
00:59	0.5	0.00E+0/m3
02/02	5.0	0.00E+0/m3

The measurement unit can be changed by using the ▲▼ key.

CNT : Integrated value
 /m3 : Number of particles per one cubic meter.
 /cf : Number of particles per 28.3L.

[Display of Optional Specification]

REPEAT	30B	20:32
WAIT	0.3	0.00E+0/m3
	0.5	0.00E+0/m3
00/02	1.0	0.00E+0/m3

Above shows a display for a unit with the optional specification “0.3,0.5,1.0µm”
 (The maximum particle size will be “1.0µm” for every sampling screen.)

Cursor Operation

The cursor moves each time the “ENTER” key is pressed.

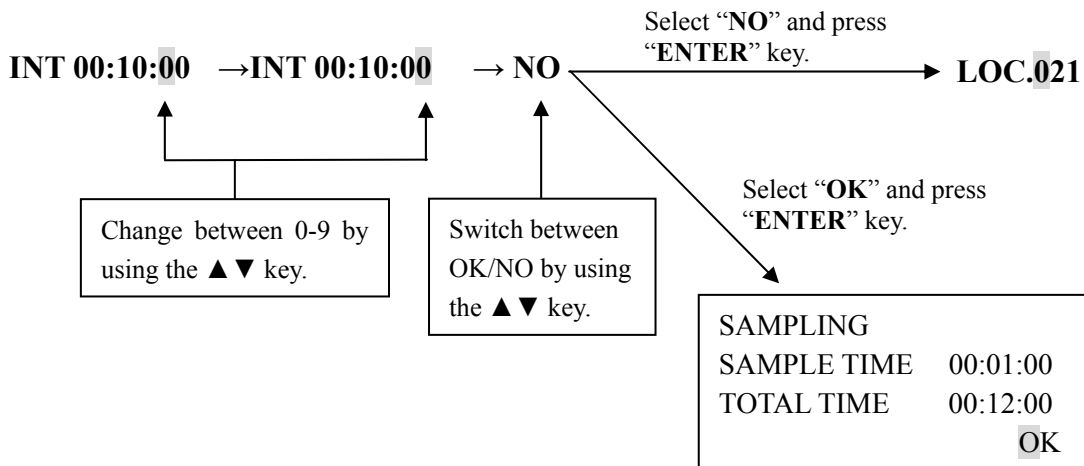
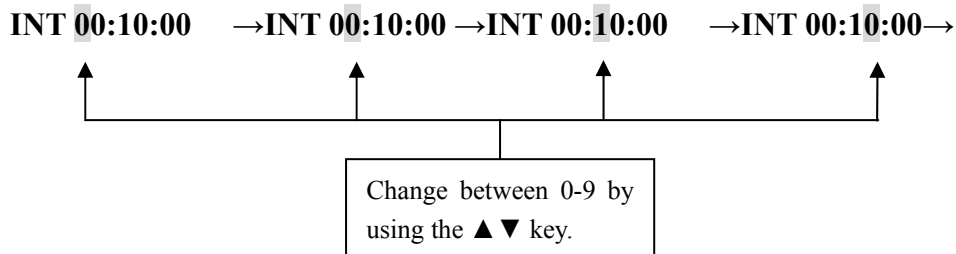
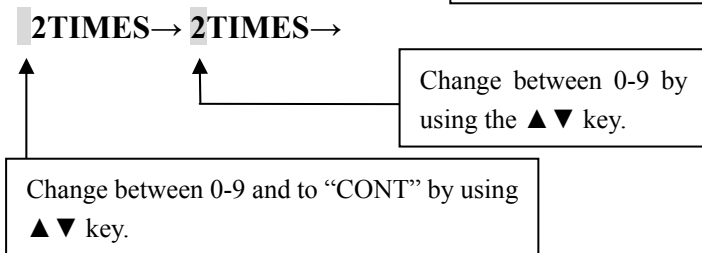
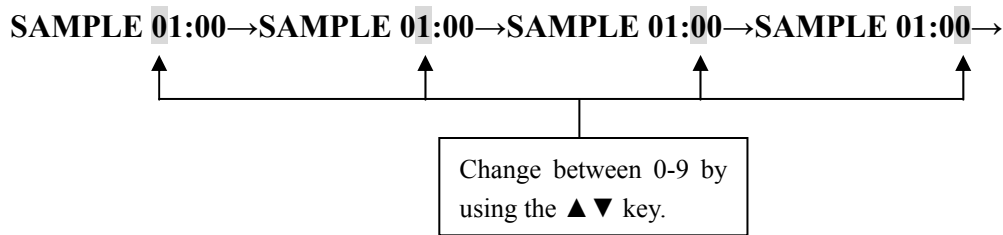
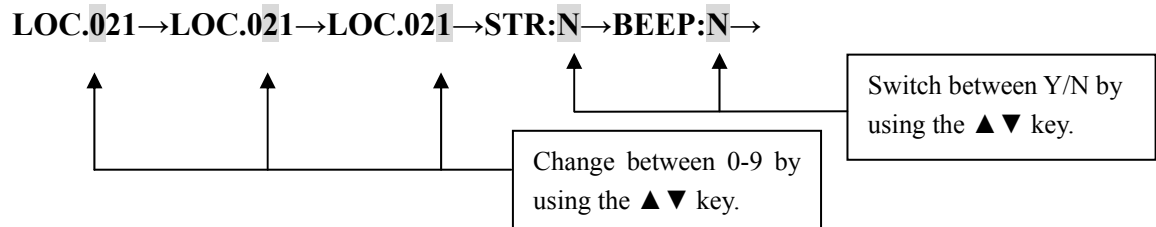

Relation between SAMPL and INT

For example, when a measurement is performed with the following setting:

REPEAT	0.3/0.5/5.0um
LOC.021	STR:N BEEP:N
SAMPLE	01:00 2TIMES
INT	00:10:00 NO

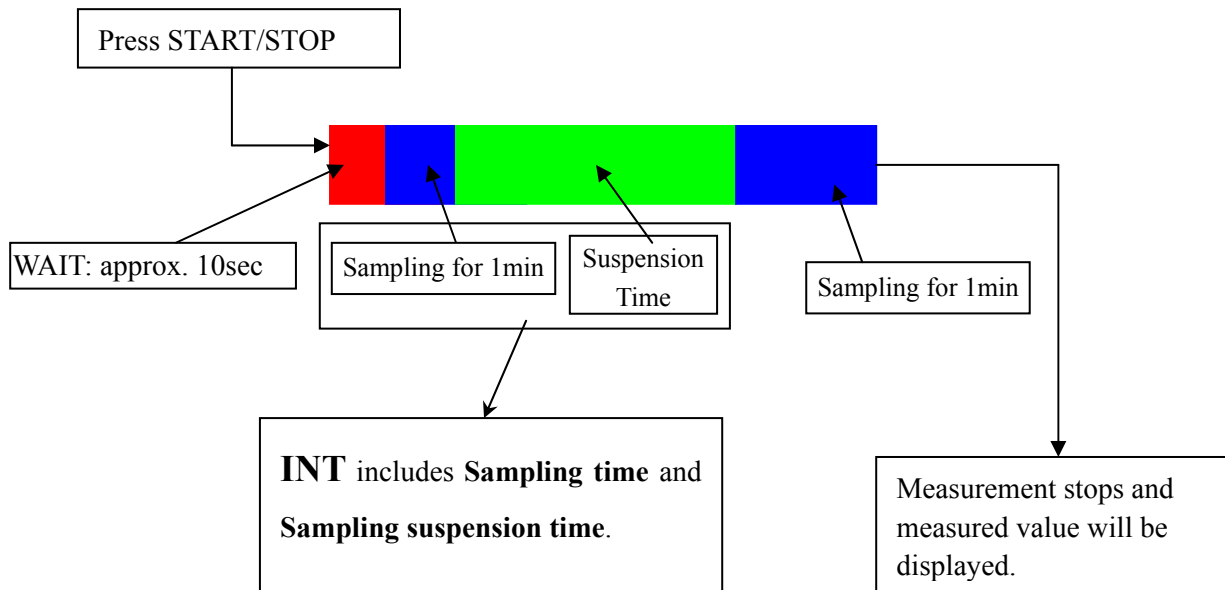

4-2 SINGLE Mode

Setup procedure is shown below.

(Character positions may not correspond to the actual screen.)

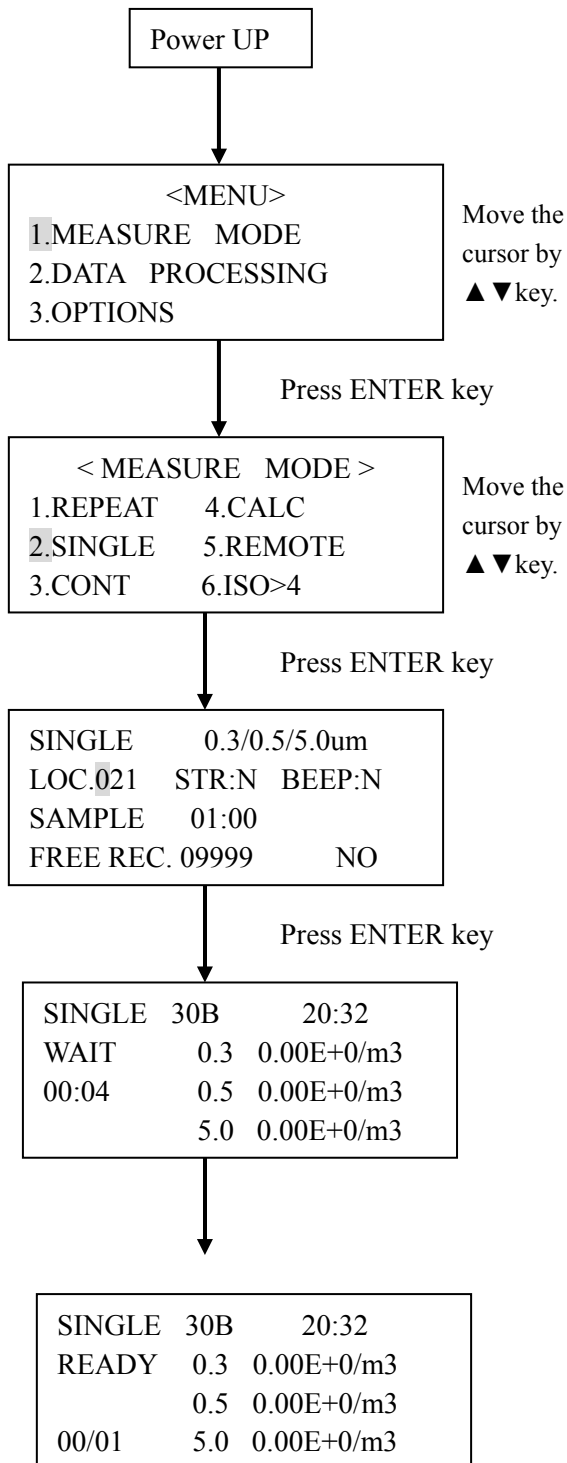

Measurement Setting Screen

LOC.:

LOC number can be used for identifying room numbers or measurements. Setting of this item is not mandatory.

STR:

Used when storing data in the instrument. When storing the data, select “Y” by using the ▲▼ key. Select “N” if you do not want to store the data.

BEEP:

Alarm goes off when alarm level is exceeded.

SAMPLE:

Sets sampling time. Setting range is from 10 sec to 99min 59sec.

FREE REC.:

Indicates remaining data storage capacity.

Setting of every item is not mandatory.

For example, you can change only the LOC number and press the START/STOP key, and the display will switch to a measurement standby screen.

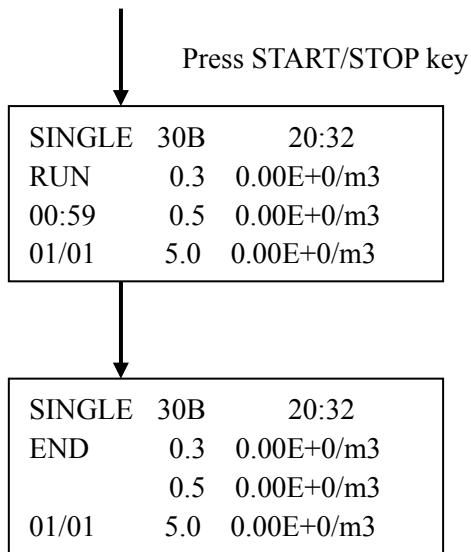

Cursor Operation

The cursor moves each time the “ENTER” key is pressed.

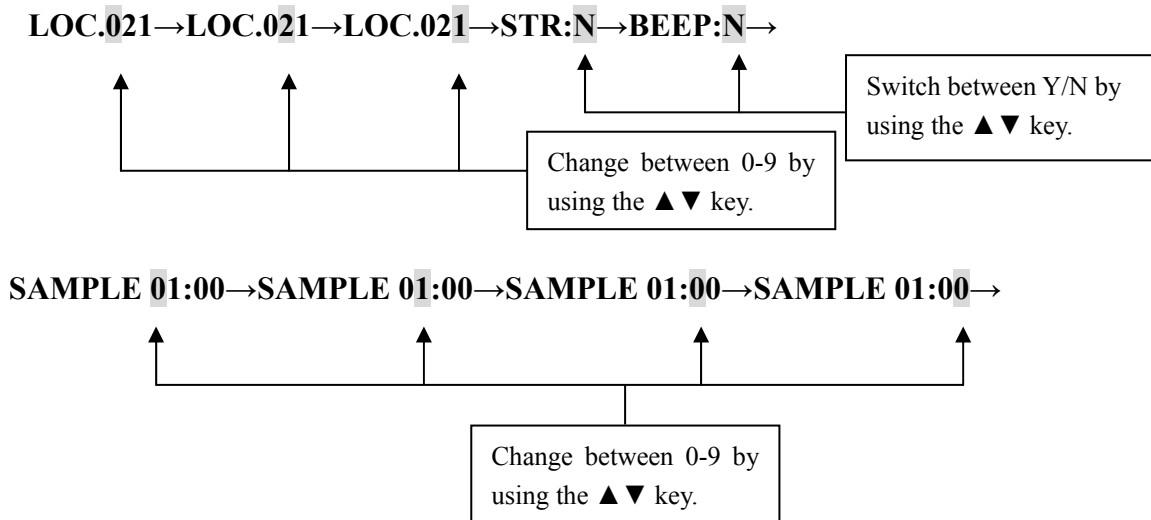

4-3 CONT Mode

Setup procedure is shown below.

(Character positions may not correspond to the actual screen.)

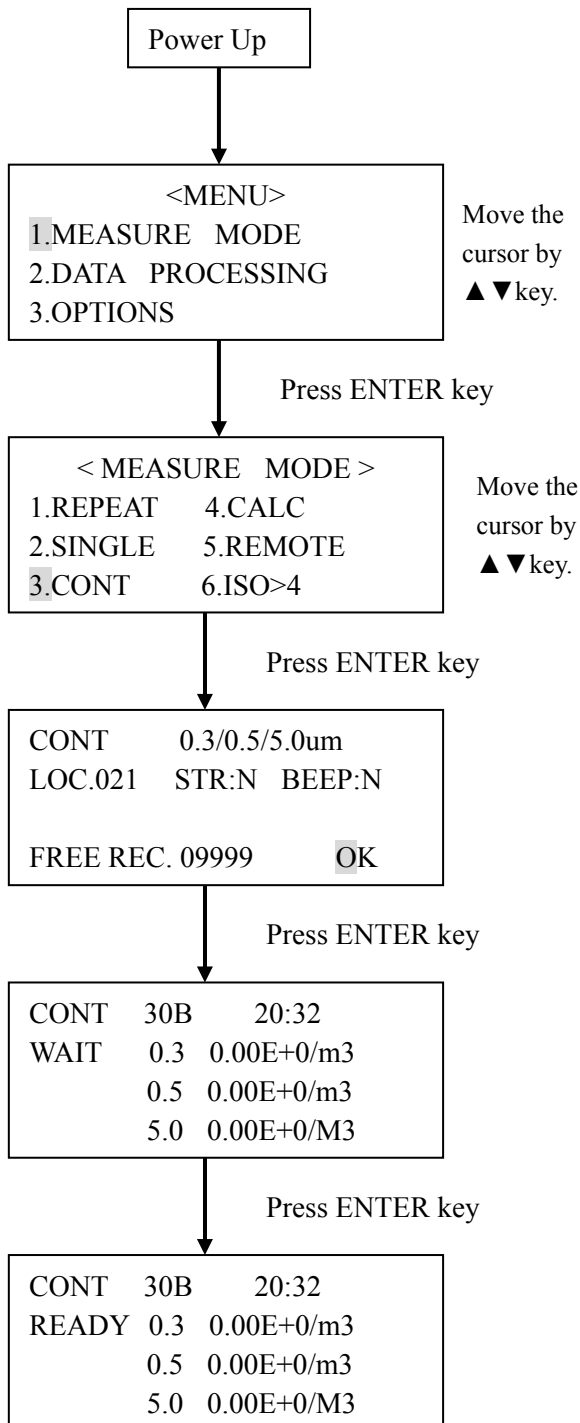

Measurement Setting Screen

LOC.:

LOC number can be used for identifying room numbers or measurements. Setting of this item is not mandatory.

STR:

Used when storing data in the instrument. When storing the data, select “Y” by using the ▲▼ key. Select “N” if you do not want to store the data.

BEEP:

Alarm goes off when alarm level is exceeded.

SAMPLE:

Sets sampling time. Setting range is from 10 sec to 99min 59 sec.

FREE REC.:

Indicates remaining data storage capacity.

Setting of every item is not mandatory.

For example, you can change only the LOC number and press the START/STOP key, and the display will switch to a measurement standby screen.

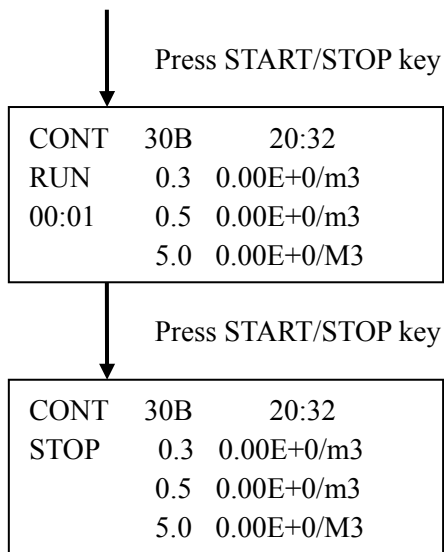

4-4 CALC Mode

Setup procedure is shown below.

(Character positions may not correspond to the actual screen.)

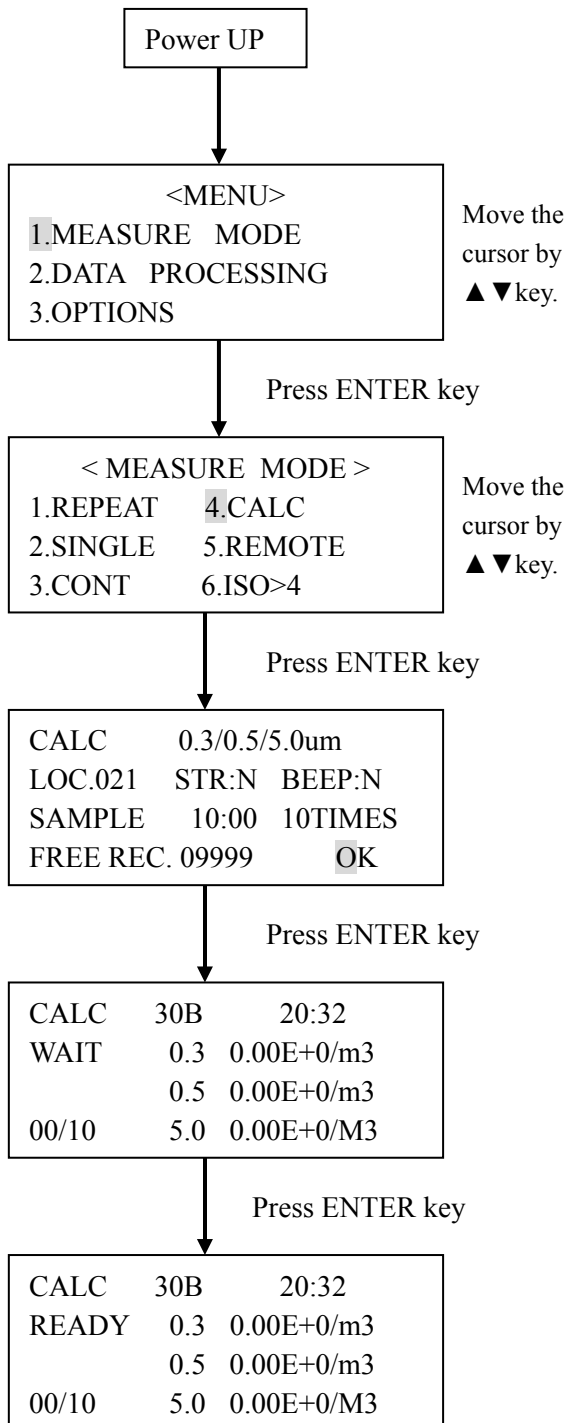

Measurement Setting Screen

LOC.:

LOC number can be used for identifying room numbers or measurements. Setting of this item is not mandatory.

STR:

Used when storing data in the instrument. When storing the data, select “Y” by using the ▲▼ key. Select “N” if you do not want to store the data.

BEEP:

Alarm goes off when alarm level is exceeded.

SAMPLE:

Sets sampling time. Setting range is from 10 sec to 99min 59sec.

FREE REC.:

Indicates remaining data storage capacity.

Setting of every item is not mandatory.

For example, you can change only the LOC number and press the START/STOP key, and the display will switch to a measurement standby screen.

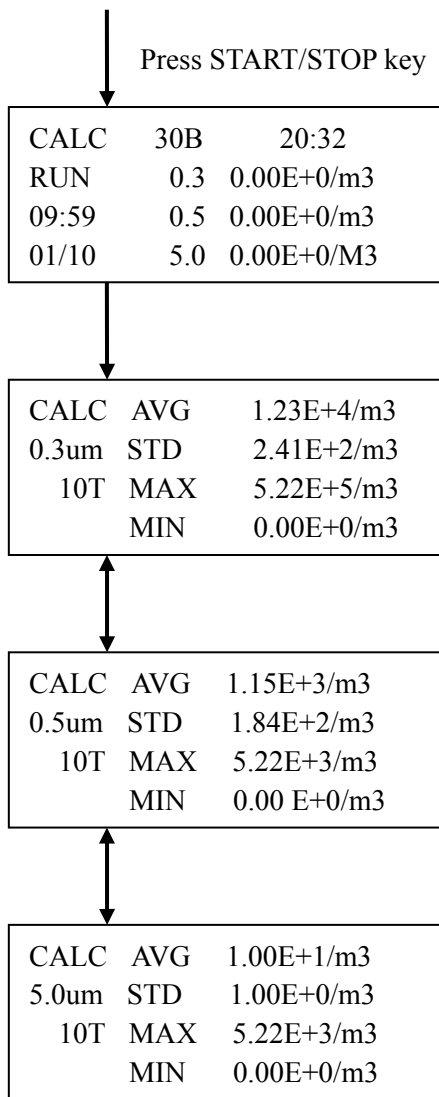

Displayed particle size can be changed by using the ▲▼ key. When “STR” is set to “Y”, the data will be stored in the instrument.

4-5 REMOTE Mode

Setup procedure is shown below.

(Character positions may not correspond to the actual screen.)

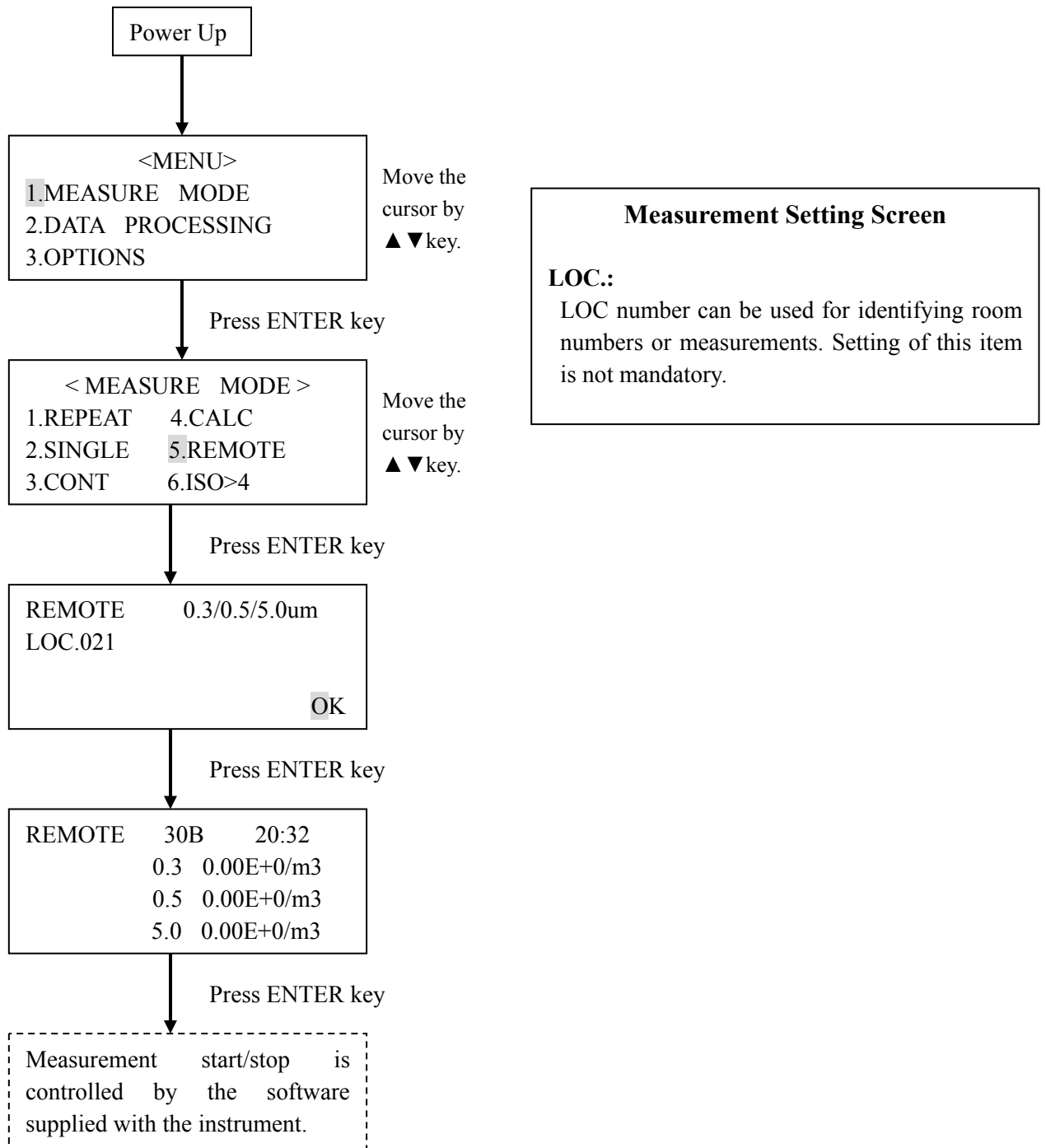

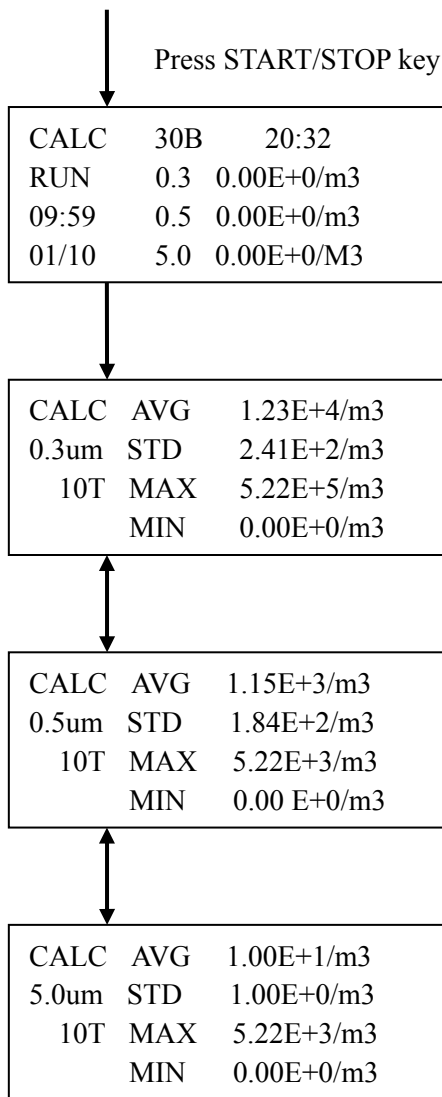

Displayed particle size can be changed by using the ▲▼ key. When “STR” is set to “Y”, the data will be stored in the instrument.

4-6 ISO>4 Mode

Setup procedure is shown below.

(Character positions may not correspond to the actual screen.)

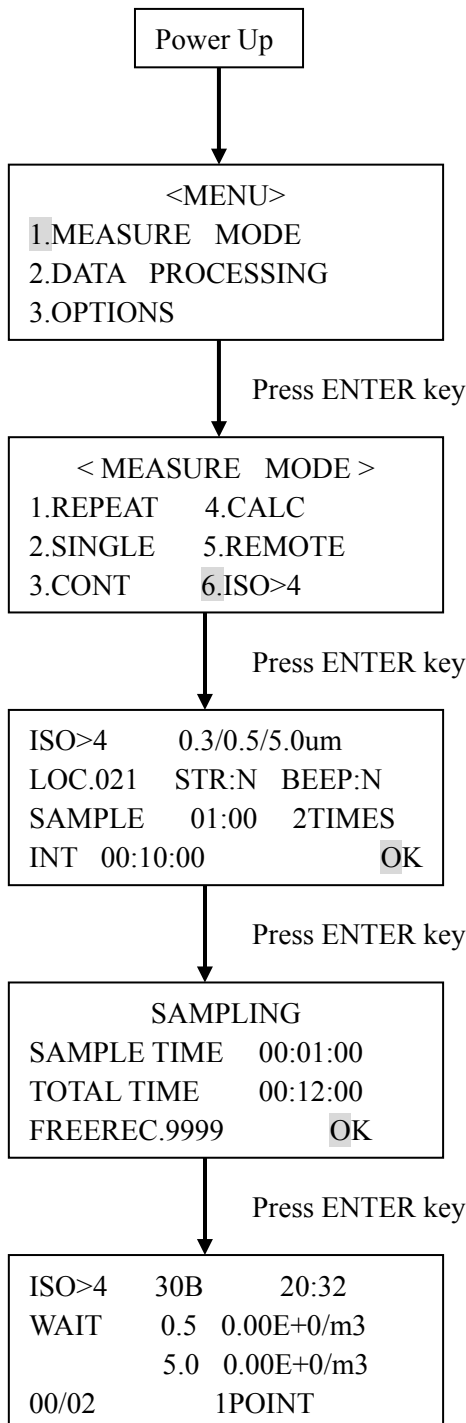

Measurement Setting Screen

LOC.:

LOC number can be used for identifying room numbers or measurements. Setting of this item is not mandatory.

STR:

Used when storing data in the instrument. When storing the data, select "Y" by using the ▲▼ key. Select "N" if you do not want to store the data.

BEEP:

Alarm goes off when alarm level is exceeded.

SAMPLE:

Sets sampling time. Setting range is from 10 sec to 99min 59sec.

TIMES:

Sets number of sampling times. Setting range is from 1 to 99, or CONT (Repeats until storage capacity is reached. Max. 10,000 times.)

INT:

Sets duration of one measurement cycle. Setting range is from 10sec to 99min 59sec. Minimum time is dependent on set sampling time.

Setting of every item is not mandatory.

For example, you can change only the LOC number and press the START/STOP key, and the display will switch to a measurement standby screen.

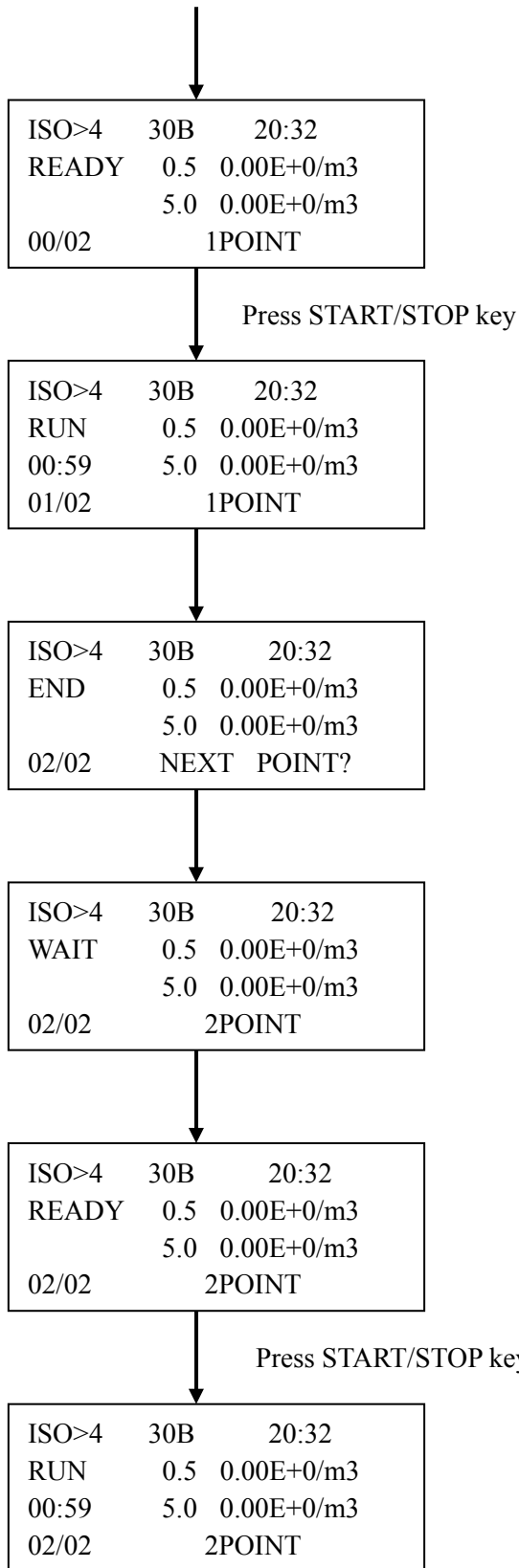

The measurement unit can be changed by using the ▲ ▼ key.

CNT : Integrated value
 /m3 : Number of particles per one cubic meter.
 /cf : Number of particles per 28.3L.

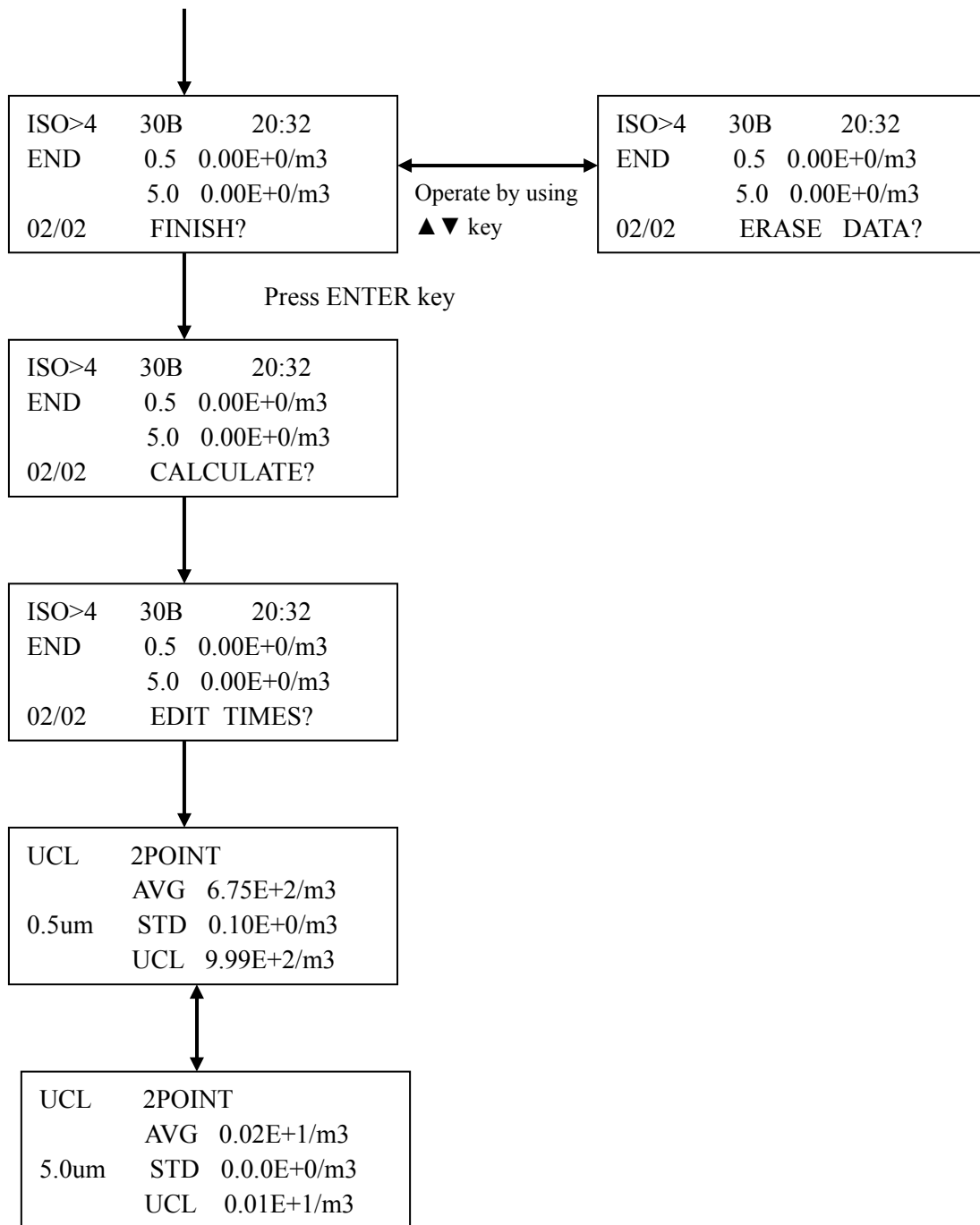

5. View Stored Data

Data stored in the LPC can be viewed on the screen or by printing.

Displaying on the LPC screen -----

View in “DISPLAY” mode.

Printing output -----

An optional printer and printer cable sold separately are required for printing.

5-1 Viewing Stored Data on LPC Screen

The data stored in the LPC can be viewed on its screen by the following procedure.

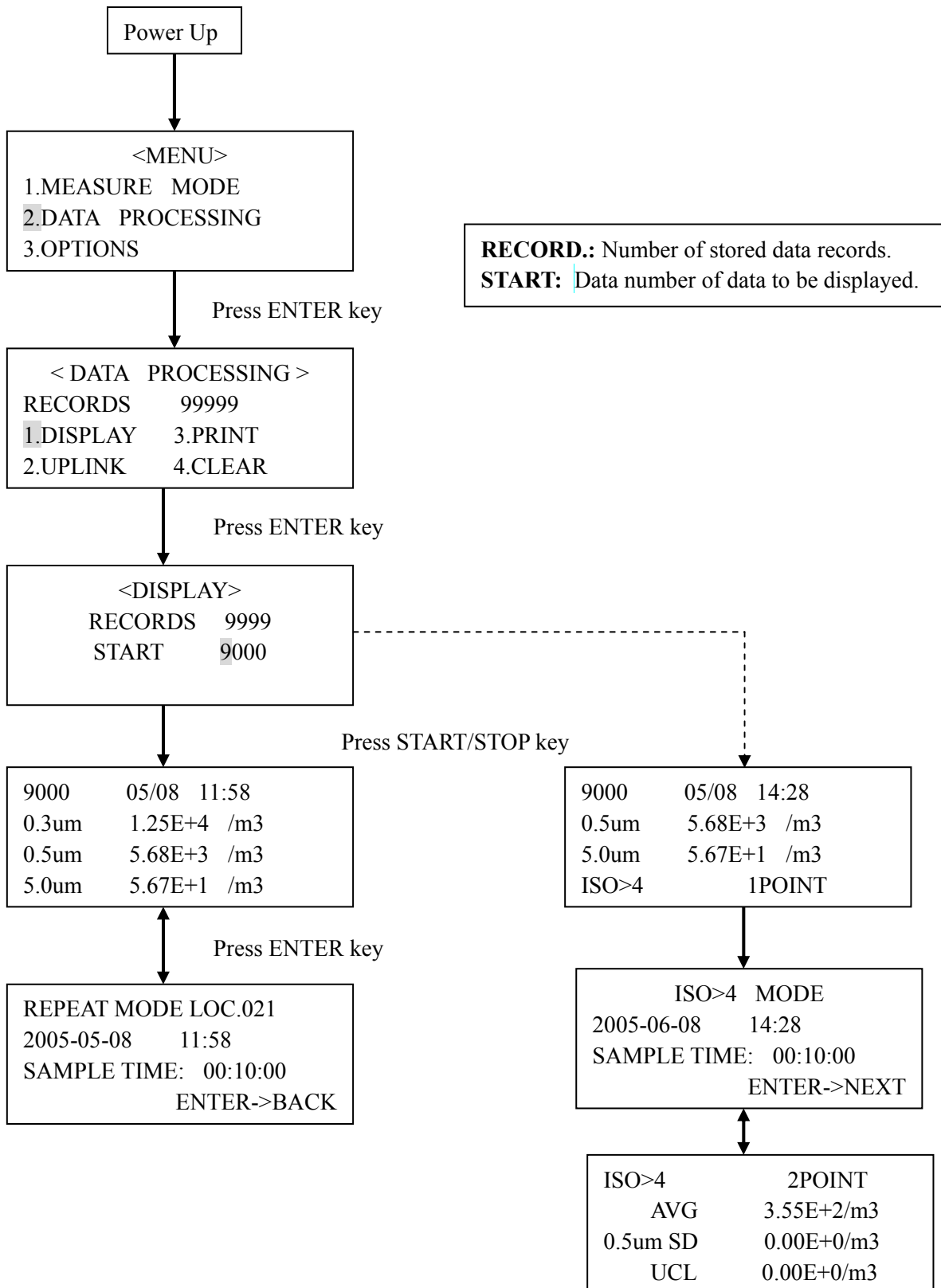

5-2 Printing Stored Data

Required Items:

To print the measured data, a dedicated cable and printer is required.

Printer Cable	MODEL 3887-07
Printer	DPU-H245

Connect the printer cable to the communication connector of the instrument.

Power up the printer. (Internal setting is not necessary.)

The data stored in the instrument can be printed out from the dedicated printer connected to the instrument by the following procedure.

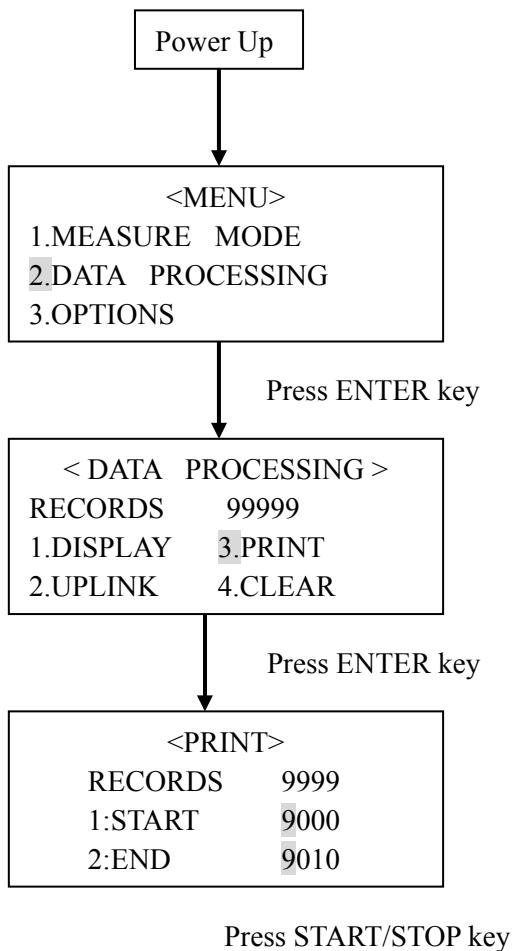

- Print Example

(1) REPEAT, SINGLE, CONTINUOUS Mode

2000 / 03 / 21	16:40	E=
REPEAT	RECORDS : 00008	
	LOCATION : 188	
TEST:01:00	INT : 00 : 05 : 30	
0.3um	564700 CNT	
0.5um	10457 CNT	
1.0um	323 CNT	

(2) CALCULATION Mode

2000 / 03 / 21	16:40	E=LFO
CALCULATION	MODE	RECORDS:00046
		TO:00047
		LOCATION:188
TEST : 13 : 23		10 TIMES
0.3um AVG	6.66E+04	CNT
SD	3.94E+03	CNT
MAX	71334	CNT
MIN	60875	CNT
0.5um AVG	2.78E+03	CNT
SD	2.76E+02	CNT
MAX	3096	CNT
MIN	2422	CNT
1.0um AVG	9.83E+01	CNT
SD	3.90E+01	CNT
MAX	156	CNT
MIN	67	CNT

Unit: As stored

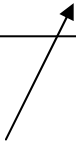

(3) ISO>4 Mode

```
ISO>4      RECORDS : 00050-00051
LOCATION: 02
2000 / 03 / 21 16 : 40    E=LFO
TEST: 01 : 00      INT:00:01:50
TIMES: 02
SIZE      AVG
0.5um    564700E+05 /m3
5.0um    10457E+02 /m3
----- 0.5um ISO>4 MODE RESULT -----
AVG      564700E+05 /m3
SD       10.457E+02 /m3
UCL      4.57E+02 /m3
----- 5.0um ISO>4 MODE RESULT -----
AVG      564700E+05 /m3
SD       10.457E+02 /m3
UCL      4.57E+02 /m3
```

5-3 Delete Stored Data

The data stored in the instrument can be deleted by the following procedure.

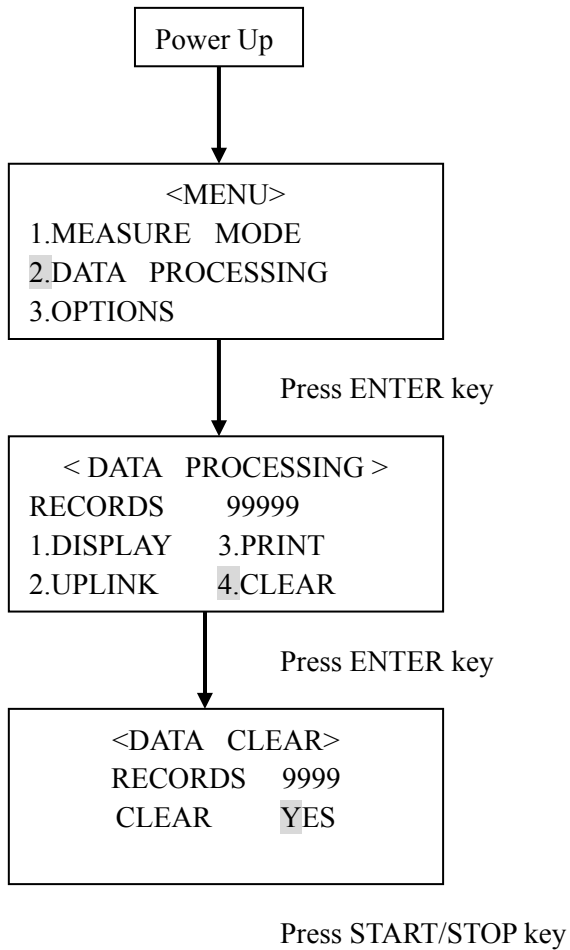

6. Useful Functions

The LPC is equipped with useful functions as listed below.

1) Alarm

Threshold can be set to activate an alarm.

2) Changing measurement unit

Measurement unit (/cf, /m³, or CNT) can be selected.

3) Calendar Setting

Calendar can be adjusted in case the initial setting needs to be adjusted.

4) Communication Setting

Communication protocol for communicating with a computer can be provided.

5) Hotkey

By pressing the START/STOP key on the <MENU> screen, the instrument will switch to a preset measurement mode.

6) Automatic Measurement Start

Measurement will start automatically when the preset time has expired.

6-1 Alarm

The procedure for setting the alarm is shown below.

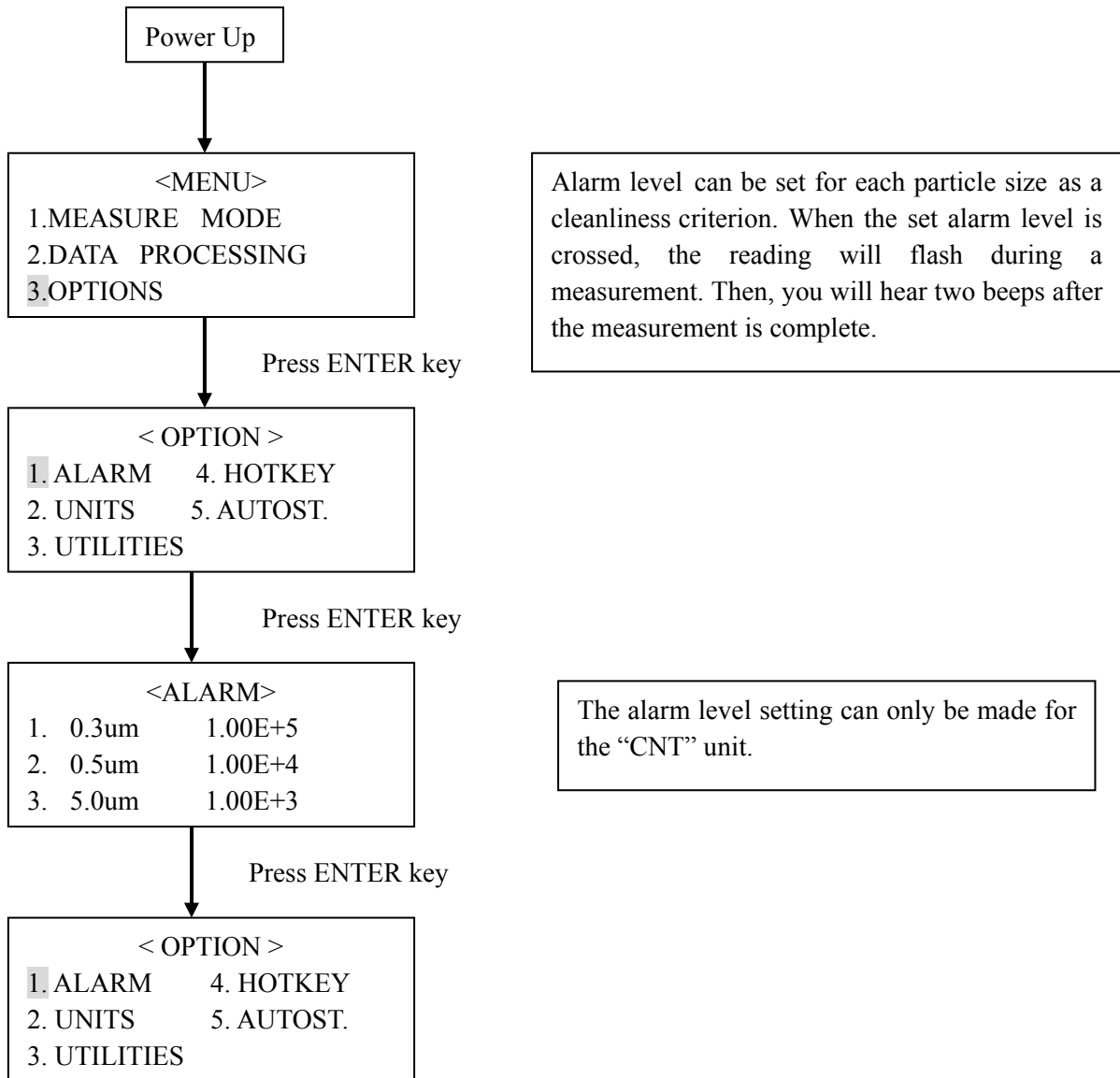

6-2 Changing Measurement Unit

The procedure for changing the measurement unit is shown below.

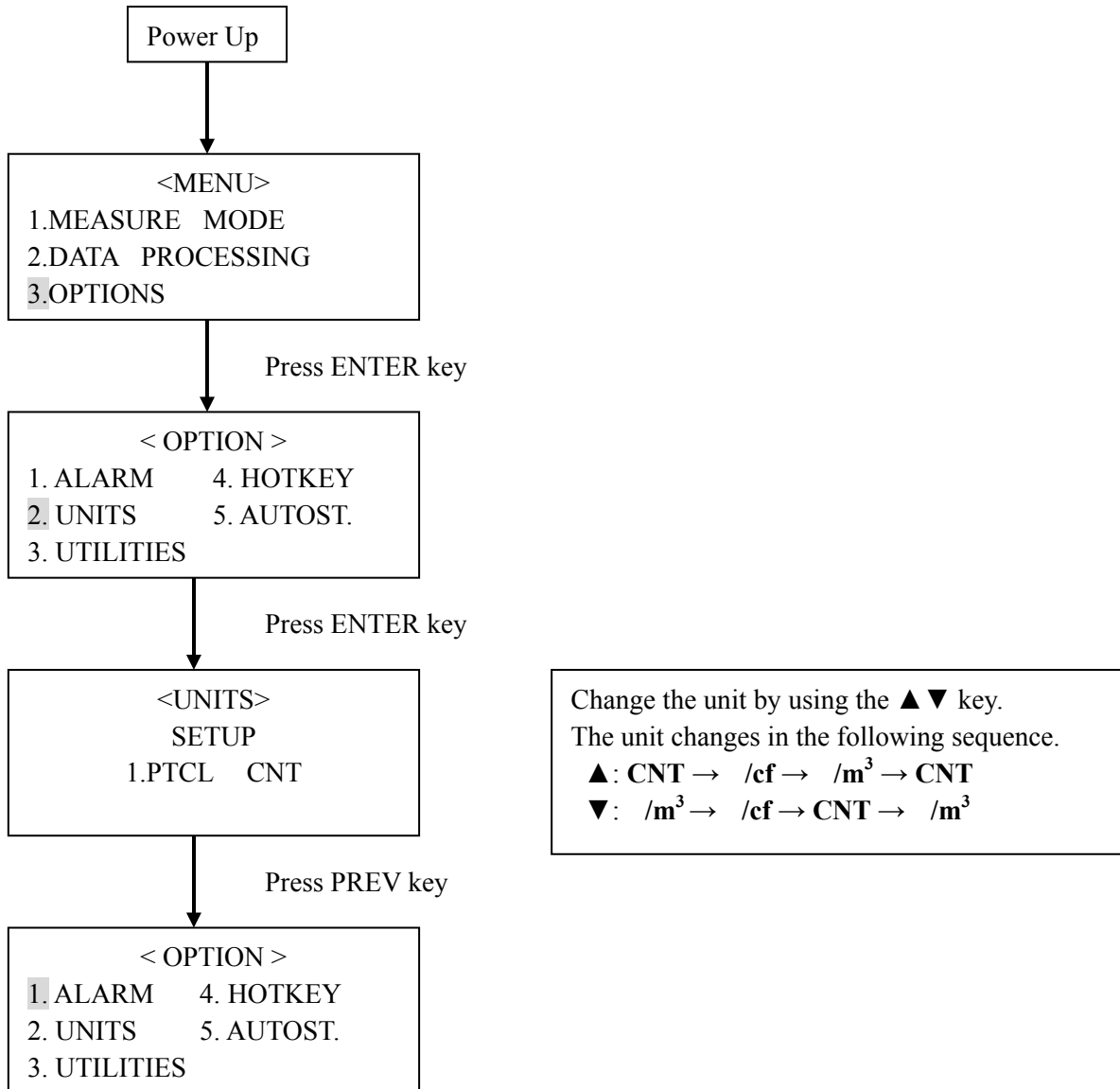

6-3 Calendar Setting

The procedure for adjusting the calendar is shown below.

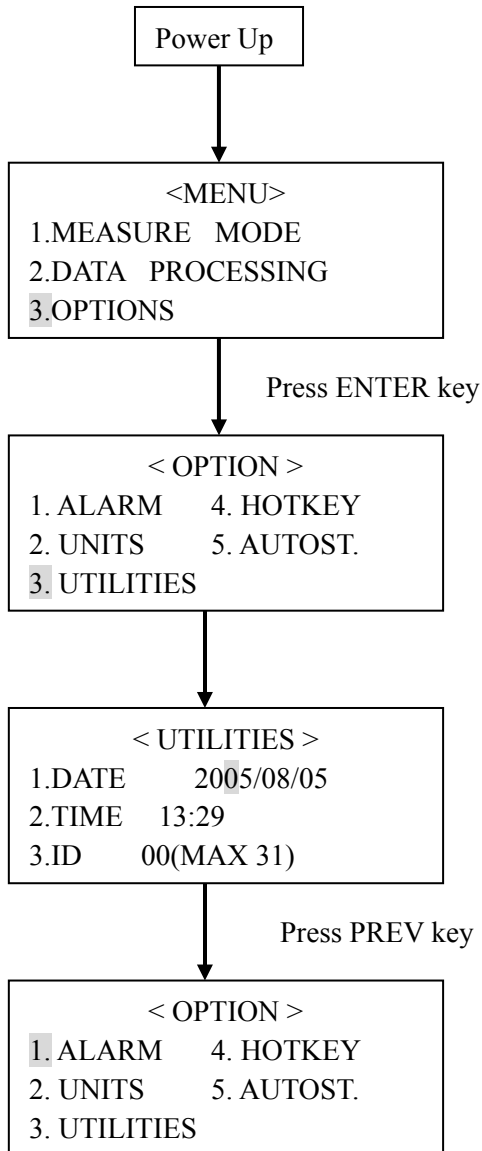

Change the value by using the ▲▼ key.
The cursor can be moved to the next digit by pressing the ENTER key.

2005/08/05
↓
2005/08/05
↓
2005/08/05
↓
2005/08/05
↓
2005/08/05
↓
13:29
↓
13:29
↓
13:29
↓
13:29

If an incorrect setting is made (e.g. 2005/13/34), a beep sound will be made each time the ▲▼ or ENTER key is pressed. You can move between items by pressing the ENTER key, but cannot return to the previous screen by pressing the PREV key.

6-4 Communication Setting

The procedure for setting the communication protocol to communicate with a computer is shown below.

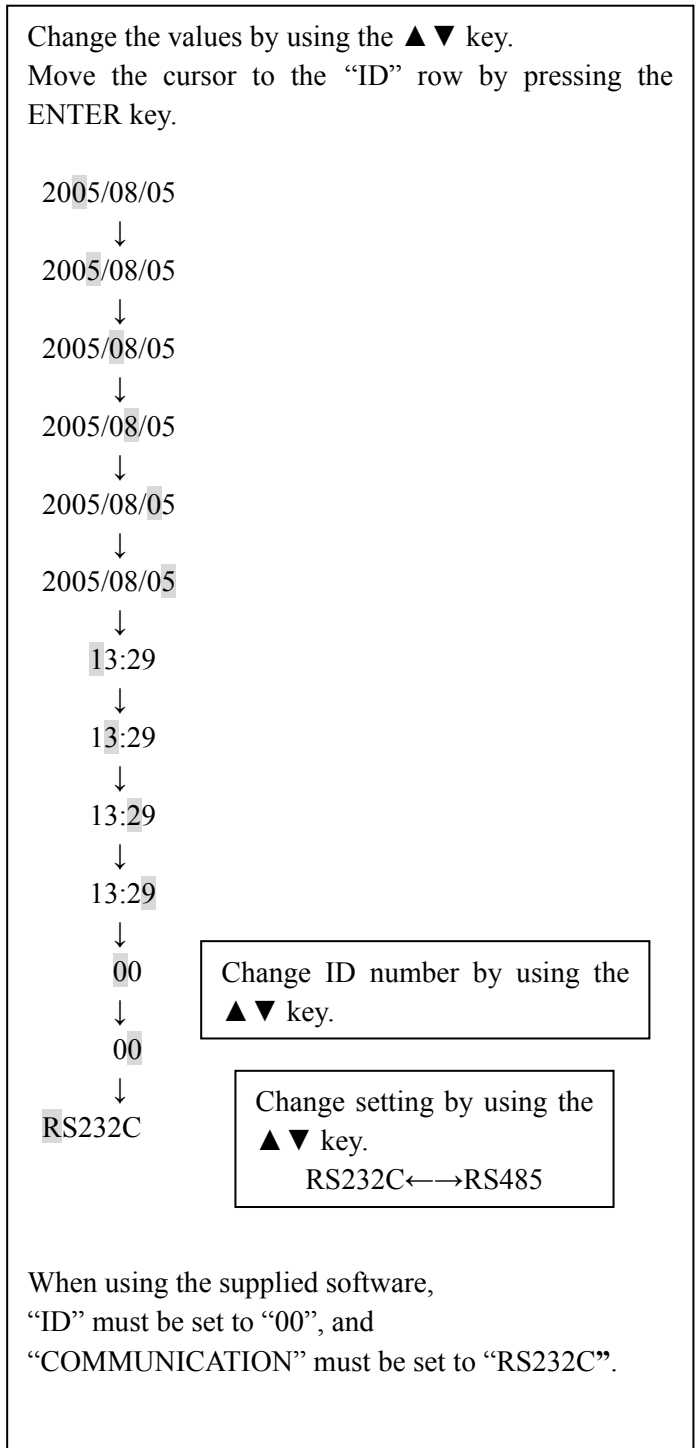
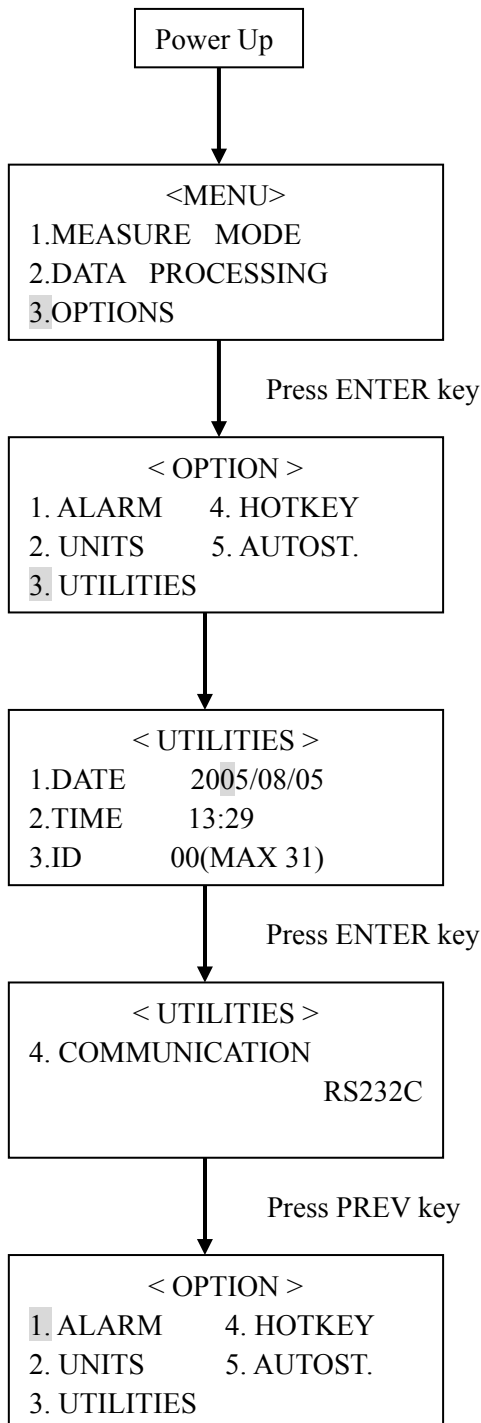

6-5 Hotkey

By presetting the HOTKEY function, measurement in the preset measurement mode can be performed on pressing the START/STOP key on the <MENU> screen.

Setup procedure is shown below.

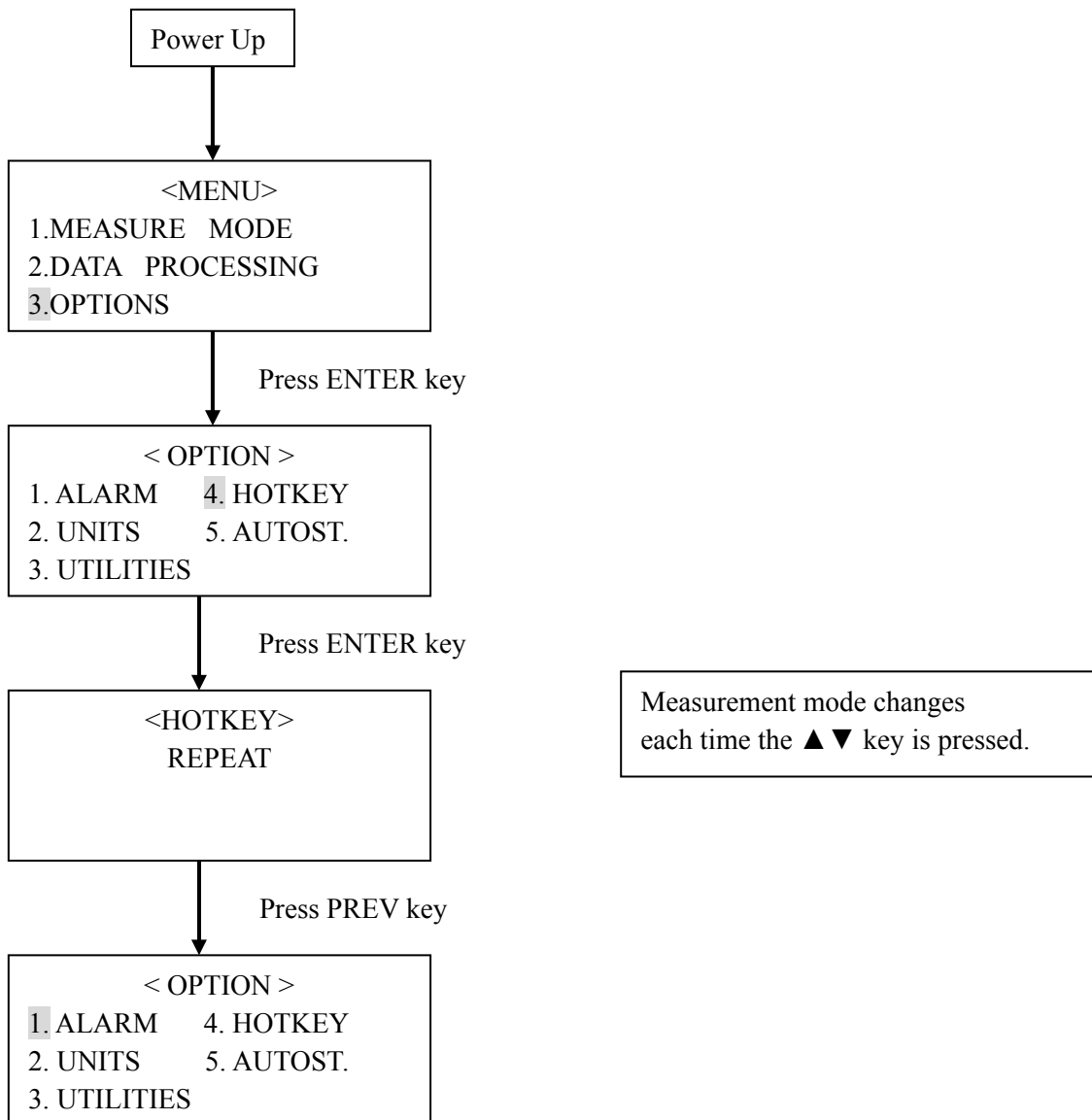

6-6 Automatic Measurement Start

Measurement will start automatically when the preset time has expired.
Setup procedure is shown below.

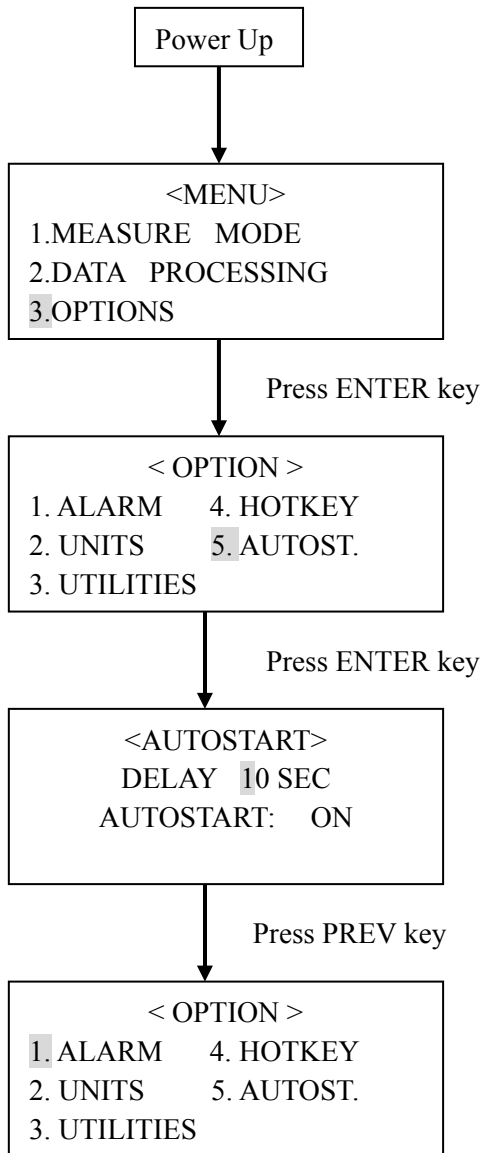

Press the ENTER key to move the cursor to the next item.

1>0>SEC>ON

Measurement mode changes each time the ▲▼ key is pressed.

7. Error Messages

When there is an error, the self-diagnosis function displays a symbol on the screen indicating an error (symbol will be displayed where “■” mark is shown below).

REPEAT	30B	■	20:32
WAIT	0.3	0.00E+0/m3	
	0.5	0.00E+0/m3	
00/02	5.0	0.00E+0/m3	

Symbol	Error Status	Solution
L	Laser power failure	Failure of laser light emitter. Please contact your local distributor or our service center.
F	Flow error	Flow rate is exceeding the specified value (2.83L/min ±10%). Remove filter or tube if attached to the inlet. If the “F” remains displayed, it may be a failure in the flow system (including pump). Please contact your local distributor or our service center.
O	Maximum measurable concentration exceeded	Measurable concentration range is exceeded. If the “O” symbol remains displayed even when the measurement is performed at a cleaner location, or by attaching the filter, please contact your local distributor or our service center.

8. Low Battery Alarm

Battery alarm will be displayed when battery capacity drops below a certain level during battery powered operation. When battery voltage drops below 4.2V, battery mark ∇ will be displayed at the upper right corner of the screen indicating that the instrument is in the Primary Alarm Level. The instrument will transfer to the Secondary Alarm Level (screen shown on the right) in approx. 5 minutes after entering the Primary Alarm Level if the AC adapter is not connected. In this Secondary Alarm Level, the pump, laser radiation, and measurement function will stop, and any operation except the operation of the power key will be disabled. The AC adapter must be connected to the instrument for continuous measurement. Insert the AC adapter and press any key except the power key. The power supply will automatically switch to the AC adapter, and the display will return to the normal measurement screen.

To turn off the power during the Secondary Alarm Level, press the power key.

It is recommended that the AC adapter is used for prolonged measurements.

- **Data Storage Condition under Battery Alarm Status:**

Data measured before the Secondary Alarm Level will be stored.

- **Data Storage Condition when Recovered from Secondary Alarm:**

If the AC adapter is connected during the Secondary Alarm Level, the status will recover to enable continuous measurement and data storage. In this case, the Secondary Alarm period during which the measurement was stopped must be taken into consideration when handling the data.

REPEAT	3B	L 15:25	∇
WAIT	0.3	0.00E+0	/cf
	0.5	0.00E+0	/cf
01/06	5.0	0.00E+0	/cf

Primary Alarm

LOW BATTERY

Secondary Alarm

Data Storage Condition of Each Measurement Mode

Measurement Mode	Data Storage Condition
REPEAT	All data taken before the Secondary Alarm will be stored.
SINGLE	Data will be stored if the measurement completes before the Secondary Alarm.
CONTINUOUS	If "STOP" is pressed before the Secondary Alarm, data up to that point will be stored.
CALCULATION	Data of the measurements performed before the Secondary Alarm will be stored.
ISO>C4	Data of the measurements performed before the Secondary Alarm will be stored.

9. Specifications

Product	Handheld Laser Particle Counter
Model	3887
Measuring Particle Size	0.3, 0.5, 5.0 μ m (Optional Specification: 0.3, 0.5, 1.0 μ m)
Flow Rate	0.1 cf/min (2.83 L/min)
Sampling Time	10 sec to 99min 59sec (1 sec increments)
Number of Sampling Times	1 to 99 times or Continuous
Measurement Modes	Total 6 modes: Single / Repeat / Continuous / Calculation / ISO>4 / Remote
Display	LCD 20 letters, 4 lines
Error Display	Excess Concentration, Laser Power Failure, Flow Error (\pm 10%), and Low Battery
External I/O	USB Mini-B Connector (Wiring is different from USB)
Communication Protocol	RS232C/RS485: Switched from the "Menu". RS232C is for communicating with a computer or printer. RS485 is for cascade connection. * In order to use RS485 for communicating with a computer, the computer must be equipped with a RS485 I/F.
Baud Rate	9600bps (115200bps when linked by data transfer software.)
Buffer Memory	10,000 data records (CALC mode requires 4 data records for 1 measurement.)
Power	Four (4) AA Ni-MH batteries (4.8V-12.1Ah), or AC adapter (input 100-240V) *The batteries must be charged by the supplied battery charger. They cannot be charged by the AC adapter.
Battery Life	Continuous operating hours: Max 3 hours when using Ni-MH batteries. (Subject to change depending on operational conditions.)
Dimensions	111(W) \times 70(H) \times 197(D) mm
Weight	Approx. 680g (without battery)
Standard Accessories	AC Adapter, Power Cable, Ni-MH Batteries, Battery Charger, Filter, Tube, Communication Cable, Application Software, and Stand, Isokinetic Probe, Traceability Certificate
Options	Printer, Printer cable, Tripod, Carrying Case

*Certain test functions required in China are not included

10. Troubleshooting

If you have a problem with your unit, please check the following list for solutions.

Symptom	Possible Cause / Solution	Refer to
The display does not appear when the power is turned ON.	The AC adapter is not connected properly. → Confirm the AC adapter and power cable. Low battery → Replace the batteries. → Recharge the batteries (Ni-MH batteries)	3.1
Ni-MH battery drains fast.	Insufficient battery charge → Recharge	3.1
Reading is blinking.	Alarm level is exceeded → Confirm alarm setting	4.3
Measurement does not start.	When operating status is: WAIT → Wait until status changes to “READY”, and press “START” key. READY → Press “START” key. STOP → Press “START” key, wait until status changes to “READY”, and press “START” key again.	4
Particle count or concentration is too high.	Attach the supplied filter and confirm that the reading drops to zero. Reading drops to zero: → Concentration of measuring environment is too high. Reading remains high: → Possible instrument failure. Please contact your local distributor.	
Particle count or concentration is too low.	Confirm error status of laser power failure or flow error.	8
Reading is displayed as “##.#”	“##.#” indicates that the measurable range is exceeded.	
Printing cannot be performed.	- Setting such as the baud rate setting is not made properly. → Confirm the printer setting. - Improper cable connection. (Confirm that the printer cable is used. Not the RS232C cable.)	6.4
Can not transfer data to the computer.	- Confirm cable connection. (Confirm that the RS232C cable is used. Not the printer cable.) - Computer is not properly set for data transfer.	6.3

If the problem cannot be solved by confirming the above, please contact your local distributor or our service center.

11. Warranty and After Service

Warranty

- A warranty card is not included in this product.
- The instrument (excluding consumables such as batteries) is warranted against defects in materials and workmanship under normal use for a period of one year from the date of original purchase.

After Service

- When you have a problem with your unit, please check out the “Troubleshooting” section first.
- If that does not help, please contact your local distributor, or call our service center (See last page for contact information).
- During the warranty period, we will repair at no charge a product that proves to be defective due to material or workmanship under normal use. The limited warranty covers all defects encountered in normal use of the product, and does not apply in cases such as; loss or damage to the product due to abuse, mishandling, or alternation by the customer, or natural disaster. All return shipping charges are the responsibility of the customer.
- Repair after warranty expiration:
Upon request, we will repair the instrument at the customer’s expense, if the instrument’s performance is found to be recoverable by providing the repair.
- Replacement parts are available for a minimum period of five (5) years after termination of production. This storage period of replacement parts is considered as the period during which we can provide repair service. For further information, please contact our service center.

When making an inquiry, please provide the following information.

- * Product Name: Handheld Laser Particle Counter
- * Model Number: 3887
- * Serial Number: xxxxxx
- * Date of Purchase: Day, Month and Year
- * Description of Symptom in Detail:

12. Contact Information



U.S.A.

KANOMAX USA, INC.

PO Box 372, 219 Route 206, Andover, NJ 07821 U.S.A.

Tel: (800)-247-8887 / (973)-786-6386 **FAX:** (973)-786-7586

URL: <http://www.kanomax-usa.com/>

E-Mail: info@kanomax-usa.com

JAPAN

KANOMAX JAPAN, INC.

2-1 Shimizu Suita City, Osaka 565-0805, Japan

TEL: 81-6-6877-0183 **FAX:** 81-6-6879-5570

URL: <http://www.kanomax.co.jp/>

E-Mail: sales@kanomax.co.jp

CHINA

Shenyang Kano Scientific Instrument Co., Ltd

No. 12, 4 Jia Wencui Road Heping District

Shenyang City PRC

TEL: 86-24-23845309 **FAX:** 86-24-23898417

URL: <http://www.kanomax.com.cn/>

E-mail: sales@kanomax.com.cn